



User Guide

What You Can Do with This Machine	1
Getting Started	2
Copy	3
Fax	4
Print	5
Scan	6
Document Server	7
Web Image Monitor	8
Adding Paper and Toner	9
Troubleshooting	10
Appendix	11



For information not in this manual, refer to the HTML/PDF files on the supplied CD-ROM.



Read this manual carefully before you use this machine and keep it handy for future reference. For safe and correct use, be sure to read the Safety Information in "Read This First" before using the machine.







TABLE OF CONTENTS



How to Read the Manuals.....	6
Symbols Used in the Manuals.....	6
Model-Specific Information.....	7
Names of Major Features.....	8

1. What You Can Do with This Machine

I Want to Save Paper.....	9
I Want to Convert Documents to Electronic Formats Easily.....	10
I Want to Register Destinations.....	11
I Want to Operate the Machine More Effectively.....	12
You Can Customize the [Home] Screen as You Like.....	13
You Can Make Copies Using Various Functions.....	14
You Can Print Data Using Various Functions.....	15
You Can Utilize Stored Documents.....	16
You Can Send and Receive Faxes without Paper.....	17
You Can Send and Receive Faxes Using the Internet.....	19
You Can Use the Facsimile and the Scanner in a Network Environment.....	21
You Can Prevent Information Leakage (Security Functions).....	22
You Can Monitor and Set the Machine Using a Computer.....	23
You Can Prevent an Unauthorized Copy.....	24

2. Getting Started

Guide to Names and Functions of Components.....	25
Guide to Components  Region A (mainly Europe).....	25
Guide to Components  Region A (mainly Asia).....	27
Guide to Components  Region B (mainly North America).....	30
Guide to Functions of the Machine's Options.....	33
Guide to Functions of the Machine's External Options  Region A (mainly Europe).....	33
Guide to Functions of the Machine's External Options  Region A (mainly Asia).....	34
Guide to Functions of the Machine's External Options  Region B (mainly North America).....	34
Guide to the Names and Functions of the Machine's Control Panel.....	35
How to Use the [Home] Screen.....	38
Adding Icons to the [Home] Screen.....	39
Registering Functions in a Program.....	44
Example of Programs.....	46

Turning On/Off the Power.....	48
Turning On the Main Power.....	48
Turning Off the Main Power.....	48
When the Authentication Screen is Displayed.....	50
User Code Authentication Using the Control Panel.....	50
Logging In Using the Control Panel.....	50
Logging Out Using the Control Panel.....	51
Placing Originals.....	52
Placing Originals on the Exposure Glass  Region A (mainly Europe).....	52
Placing Originals on the Exposure Glass  Region A (mainly Asia).....	52
Placing Originals on the Exposure Glass  Region B (mainly North America).....	53
Placing Originals in the Auto Document Feeder.....	54

3. Copy

Basic Procedure.....	55
Auto Reduce/Enlarge.....	57
Duplex Copying.....	59
Specifying the Original and Copy Orientation.....	61
Combined Copying.....	62
One-Sided Combine.....	63
Two-Sided Combine.....	64
Copying onto Custom Size Paper from the Bypass Tray.....	67
Copying onto Envelopes.....	68
Sort.....	70
Changing the Number of Sets.....	70
Storing Data in the Document Server.....	72

4. Fax

Basic Procedure for Transmissions (Memory Transmission).....	73
Sending Originals Using the Exposure Glass (Memory Transmission).....	74
Registering a Fax Destination.....	75
Deleting a Fax Destination.....	76
Transmitting while Checking Connection to Destination (Immediate Transmission).....	78
Sending Originals Using the Exposure Glass (Immediate Transmission).....	79
Canceling a Transmission.....	80

Canceling a Transmission Before the Original Is Scanned.....	80
Canceling a Transmission While the Original Is Being Scanned.....	80
Canceling a Transmission After the Original Is Scanned (While a Transmission Is in Progress).....	81
Canceling a Transmission After the Original Is Scanned (Before a Transmission Is Started).....	81
Sending at a Specific Time (Send Later).....	83
Storing a Document.....	84
Sending Stored Documents.....	85
Printing the Journal Manually.....	87

5. Print

Quick Install.....	89
Displaying the Printer Driver Properties.....	90
Standard Printing.....	91
When Using the PCL 6 Printer Driver.....	91
Locked Print.....	92
Sending a Locked Print File.....	92
Printing a Locked Print File Using the Control Panel.....	92
Hold Print.....	94
Sending a Hold Print File.....	94
Printing a Hold Print File Using the Control Panel.....	94
Stored Print.....	96
Sending a Stored Print File.....	96
Printing a Stored Print File Using the Control Panel.....	97

6. Scan

Basic Procedure When Using Scan to Folder.....	99
Creating a Shared Folder on a Computer Running Windows/Confirming a Computer's Information.....	100
Registering an SMB Folder.....	102
Deleting an SMB Registered Folder.....	105
Entering the Path to the Destination Manually.....	105
Basic Procedure for Sending Scan Files by E-mail.....	107
Registering an E-mail Destination.....	108
Deleting an E-mail Destination.....	109
Entering an E-mail Address Manually.....	110

Basic Procedure for Storing Scan Files.....	111
Checking a Stored File Selected from the List.....	112
Specifying the File Type.....	113
Specifying Send Settings.....	114
7. Document Server	
Storing Data.....	115
Printing Stored Documents.....	117
8. Web Image Monitor	
Displaying Top Page.....	119
Viewing Received Fax Documents Using Web Image Monitor.....	121
9. Adding Paper and Toner	
Loading Paper into Paper Trays.....	123
Loading Paper into Tray 1.....	123
Loading Paper into Trays 2 and 3.....	124
Loading Paper into the Bypass Tray.....	127
Settings to Use the Bypass Tray under the Printer Function.....	129
Loading Orientation-Fixed Paper or Two-Sided Paper.....	132
Recommended Paper Sizes and Types.....	135
Thick Paper.....	138
Envelopes.....	139
Adding Toner.....	142
Sending Faxes or Scanned Documents When Toner Has Run Out.....	143
Disposing of Used Toner.....	144
10. Troubleshooting	
Indicators.....	145
When an Indicator for the [Check Status] Key Is Lit.....	146
Panel Tone.....	148
When You Have Problems Operating the Machine.....	149
When Messages Are Displayed on the Control Panel.....	154
Messages Displayed When Using the Copy/Document Server Function.....	154
Messages Displayed When Using the Facsimile Function.....	156
Messages Displayed When Using the Printer Function.....	169
Messages Displayed When Using the Scanner Function.....	182

When Messages Are Displayed on Your Computer Screen.....	197
Messages Displayed When Using the Scanner Function.....	197

11. Appendix

Trademarks.....	203
INDEX	205

How to Read the Manuals

Symbols Used in the Manuals

This manual uses the following symbols:

 **Important**

Indicates points to pay attention to when using the machine, and explanations of likely causes of paper misfeeds, damage to originals, or loss of data. Be sure to read these explanations.

 **Note**

Indicates supplementary explanations of the machine's functions, and instructions on resolving user errors.

 **Reference**

This symbol is located at the end of sections. It indicates where you can find further relevant information.

[]

Indicates the names of keys on the machine's display or control panels.



Indicates instructions stored in a file on a provided CD-ROM.

 **Region A** (mainly Europe and Asia), (mainly Europe), or (mainly Asia)

 **Region B** (mainly North America)

Differences in the functions of Region A and Region B models are indicated by two symbols. Read the information indicated by the symbol that corresponds to the region of the model you are using. For details about which symbol corresponds to the model you are using, see p.7 "Model-Specific Information".

Model-Specific Information

This section explains how you can identify the region your machine belongs to.

There is a label on the rear of the machine, located in the position shown below. The label contains details that identify the region your machine belongs to. Read the label.

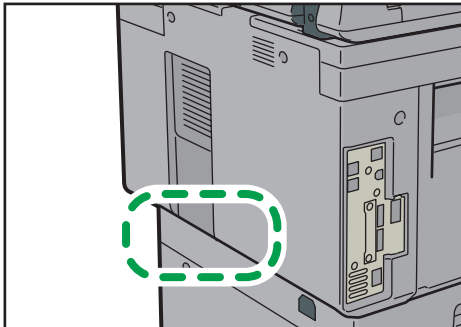

CMR015

The following information is region-specific. Read the information under the symbol that corresponds to the region of your machine.

Region A (mainly Europe and Asia)

If the label contains the following, your machine is a region A model:



- CODE XXXX -27, -29
- 220–240 V

Region B (mainly North America)

If the label contains the following, your machine is a region B model:

- CODE XXXX -17
- 120–127 V

Note

- Dimensions in this manual are given in two units of measure: metric and inch. If your machine is a Region A model, refer to the metric units. If your machine is a Region B model, refer to the inch units.
- If your machine is a region A model and "CODE XXXX -27" is printed on the label, see " **Region A** (mainly Europe)".
- If your machine is a region A model and "CODE XXXX -29" is printed on the label, see " **Region A** (mainly Asia)".

Names of Major Features

In this manual, major features of the machine are referred to as follows:

- Auto Document Feeder → ADF

1. What You Can Do with This Machine

You can search for a description by what you want to do.

I Want to Save Paper

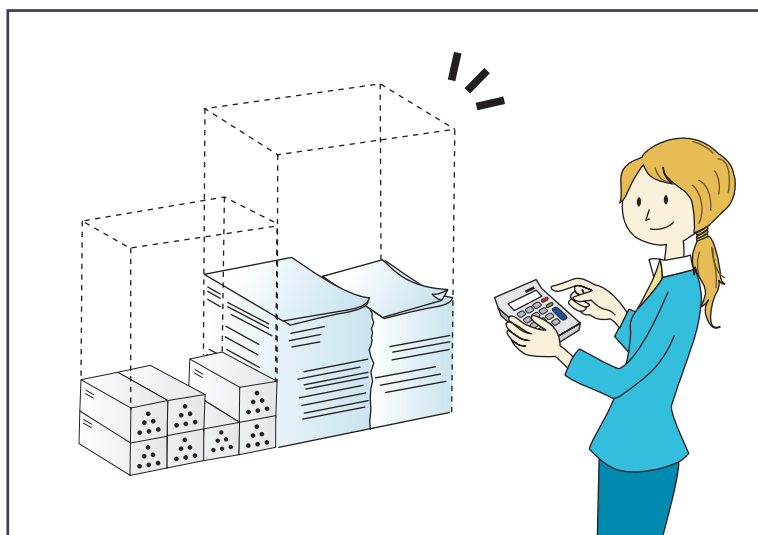

BRL059S

Printing multi-page documents on both sides of sheets (Duplex Copy)

⇒ See "Duplex Copying", Copy/ Document Server .

Printing multi-page documents and received faxes on a single sheet (Combine (Copier/Fax))

⇒ See "Combined Copying", Copy/ Document Server .

⇒ See "Combine Two Originals", Fax .

Printing received faxes on both sides of sheets (2 Sided Print)

⇒ See "Two-Sided Printing", Fax .

Converting received faxes to electronic formats (Paperless Fax)

⇒ See "Confirming/Printing/Deleting Received and Stored Documents", Fax .

Sending files from the computer without printing them (LAN-Fax)

⇒ See "Sending Fax Documents from Computers", Fax .

Checking how much paper is saved ([Information] screen)

⇒ See "How to Use the [Information] Screen", Getting Started .

I Want to Convert Documents to Electronic Formats Easily

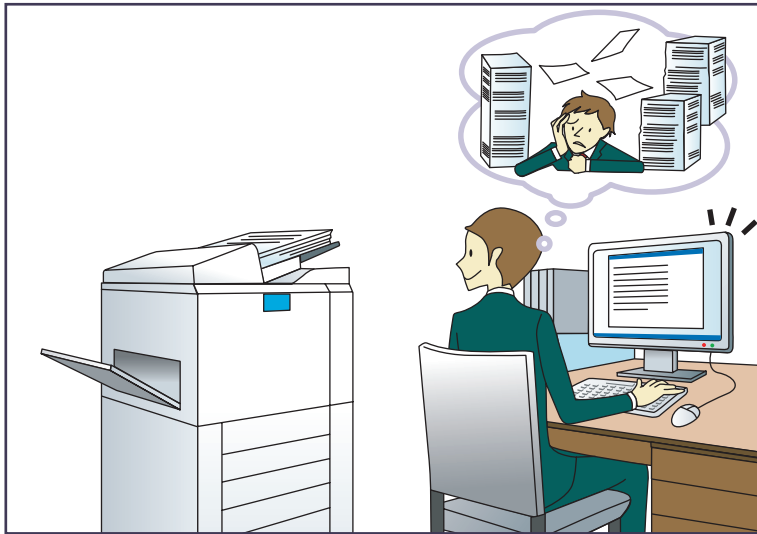

BQX138S

Sending scan files

⇒ See "Basic Procedure for Sending Scan Files by E-mail", Scan .

Sending the URL of the folder in which scan files are stored

⇒ See "Sending the URL by E-mail", Scan .

Storing scan files in a shared folder

⇒ See "Basic Procedure When Using Scan to Folder", Scan .

Storing scan files on media

⇒ See "Basic Procedure for Saving Scan Files on a Removable Memory Device", Scan .

Converting transmitted faxes to electronic formats and sending them to a computer

⇒ See "Overview of Folder Transmission Function", Fax .

Managing and using documents converted to electronic formats (Document Server)

⇒ See "Relationship between Document Server and Other Functions", Copy/ Document Server .

I Want to Register Destinations

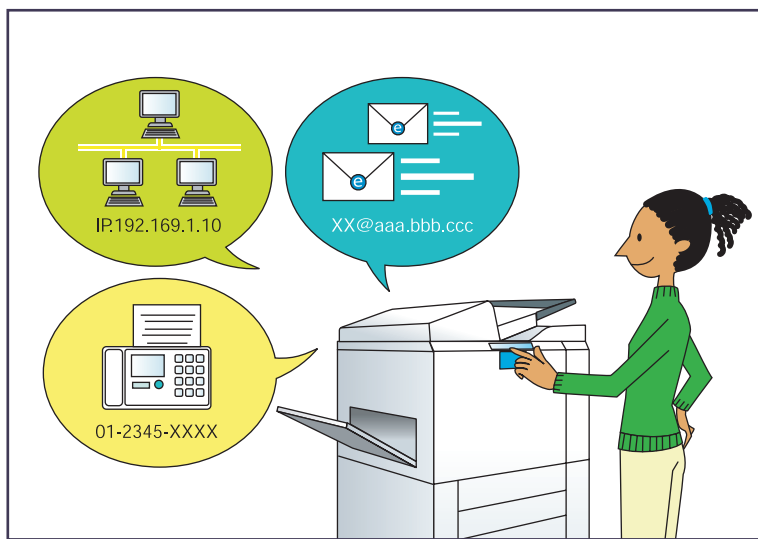

Using the control panel to register destinations in the Address Book

⇒ See "Registering Entered Destinations to the Address Book", Fax .

⇒ See "Registering a destination in the address book manually", Scan .

Using Web Image Monitor to register destinations from a computer

⇒ See "Registering Internet Fax Destination Information Using Web Image Monitor", Fax .

Downloading destinations registered in the machine to the LAN-Fax driver destination list

⇒ See "Using the machine's Address Book as the LAN-Fax destination list", Fax .

I Want to Operate the Machine More Effectively



BQX139S

Registering and using frequently-used settings (Program)

⇒ See "Registering Functions in a Program", Convenient Functions .

Registering frequently-used settings as initial settings (Program as Defaults (Copier/Document Server/Fax/Scanner))

⇒ See "Changing the Default Functions of the Initial Screen", Convenient Functions .

Registering frequently-used printing settings to the printer driver

⇒ See "Using One Click Presets", Print .

Changing the initial settings of the printer driver to frequently-used printing settings

⇒ See "Displaying the Printing Preferences Dialog Box", Print .

Adding shortcuts to frequently used programs or Web pages

⇒ See "Adding Icons to the [Home] Screen", Convenient Functions .

Changing the order of the function and shortcut icons

⇒ See "Changing the Order of Icons on the [Home] Screen", Convenient Functions .

You Can Customize the [Home] Screen as You Like

The icons of each function are displayed on the [Home] screen.

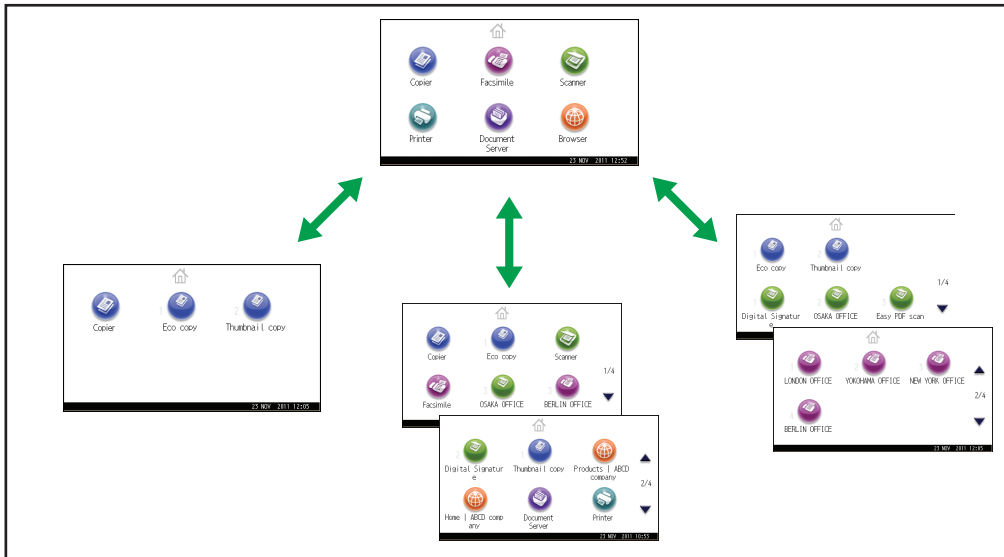

CMQ001

- You can add shortcuts to often used programs or Web pages to the [Home] screen. The programs or Web pages can be recalled easily by pressing the shortcut icons.
- You can display only the icons of functions and shortcuts that you use.
- You can change the order of the function and shortcut icons.

Reference

- For details about the features on the [Home] screen, see "How to Use the [Home] Screen", Getting Started .

You Can Make Copies Using Various Functions

1

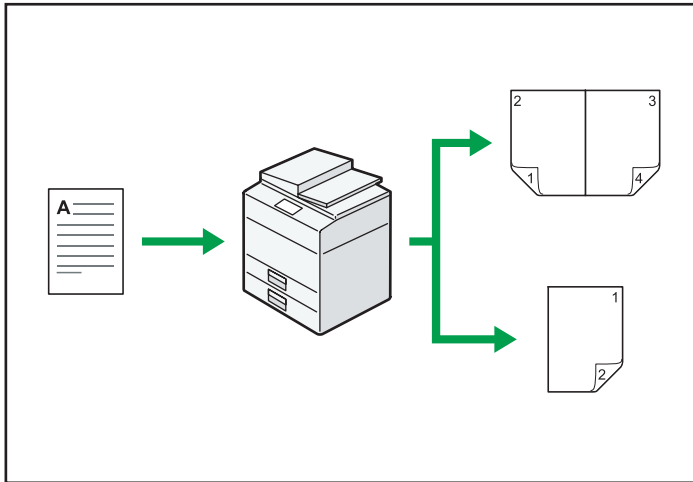

CMQ002

- You can reduce or enlarge the copy image. With the Auto Reduce/Enlarge function, the machine automatically calculates the reproduction ratio based on the sizes of the originals and the paper you have specified.
- Copier functions such as Duplex and Combine allow you to save on paper by copying multiple pages onto single sheets.
- You can copy onto various types of paper such as envelopes and OHP transparencies.
- You can sort copies.

Reference

- See Copy/ Document Server .

You Can Print Data Using Various Functions

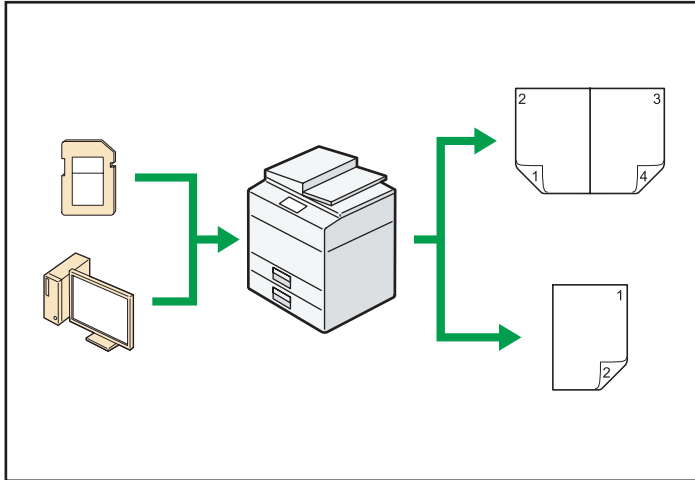

CMQ004

- This machine supports network and local connections.
- You can send PDF files directly to the machine for printing, without having to open a PDF application.
- You can print or delete print jobs stored on the machine's hard disk, which have been previously sent from computers using the printer driver. The following types of print jobs can be selected: Sample Print, Locked Print, Hold Print, and Stored Print.
- You can collate printed paper.
- You can print files stored on a removable memory device and specify print conditions such as print quality and print size.

Reference

- See Print .

You Can Utilize Stored Documents

1



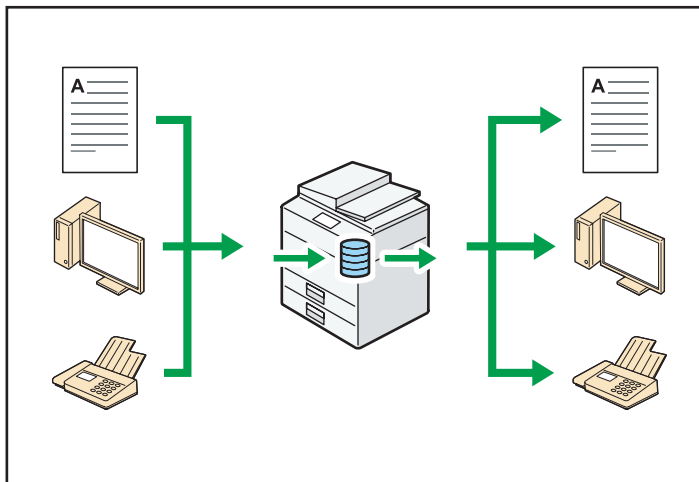

You can store files scanned in copier, facsimile, printer, or scanner mode on the machine's hard disk. With Web Image Monitor, you can use your computer to search for, view, print, delete, and send stored files via the network. You can also change print settings and print multiple documents (Document Server).



CJQ603

- You can retrieve stored documents scanned in scanner mode to your computer.
- Using the file format converter, you can download documents stored in copier, Document Server, or printer mode to your computer.

Reference

- For details about the Document Server in copier mode and how to use the Document Server, see "Storing Data in the Document Server" and "Document Server", Copy/ Document Server .
- For details about the Document Server in printer mode, see "Saving and Printing Using the Document Server", Print .
- For details about the Document Server in fax mode, see "Storing a Document", Fax .
- For details about the Document Server in scanner mode, see "Storing and Saving the Scanned Documents", Scan .

You Can Send and Receive Faxes without Paper

1

Reception

You can store and save received fax documents as electronic formats in the machine's hard disk without printing them.

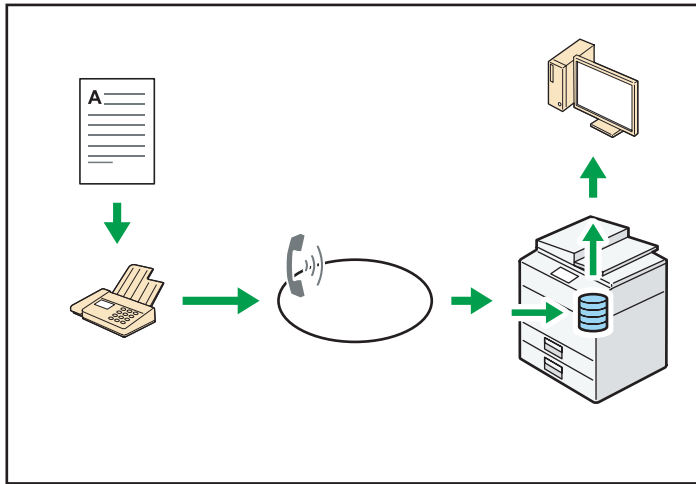

CJQ604

You can use Web Image Monitor to check, print, delete, retrieve, or download documents using your computer (Storing received documents).

Reference

- See "Confirming/Printing/Deleting Received and Stored Documents", Fax .

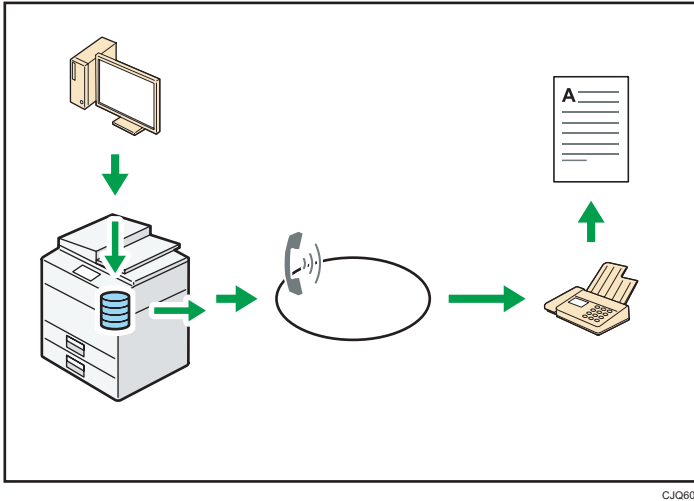

Transmission

You can send a fax from your computer over the network (Ethernet or wireless LAN) to this machine, which then forwards the fax via its telephone connection (LAN-Fax).



- To send a fax, print from the Windows application you are working with, select LAN-Fax as the printer, and then specify the destination.
- You can also check the sent image data.

Reference

- For details about the machine's settings, see "Network Settings Requirements", Connecting the Machine/ System Settings .
- For details about how to use the function, see "Fax via Computer", Fax .

You Can Send and Receive Faxes Using the Internet

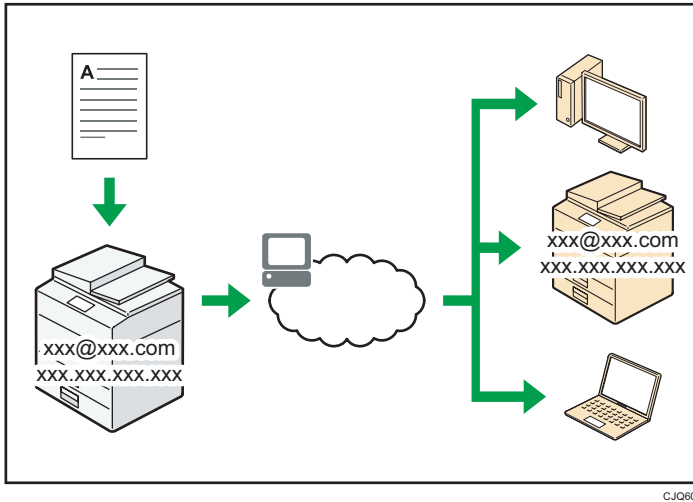

CJ0606

E-mail Transmission and Reception

This machine converts scanned document images to e-mail format, and transmits and receives this data over the Internet.

- To send a document, specify an e-mail address instead of dialing the destination telephone number (Internet Fax and e-mail transmission).
- This machine can receive e-mail messages via Internet Fax or from computers (Internet Fax Reception and Mail to Print).
- Internet Fax compatible machines and computers that have e-mail addresses can receive e-mail messages via Internet Fax.

IP-Fax

The IP-Fax function sends or receives documents between two facsimiles directly via a TCP/IP network.

- To send a document, specify an IP address or host name instead of a fax number (IP-Fax Transmission).
- This machine can receive documents sent via Internet Fax (IP-Fax Reception).
- Using a VoIP gateway, this machine can send to G3 facsimiles connected to the public switched telephone network (PSTN).

Reference

- For details about settings, see "Network Settings Requirements", Connecting the Machine/ System Settings .

- For details about how to transmit and receive documents over the Internet, see "Transmission" and "Reception", Fax .

You Can Use the Facsimile and the Scanner in a Network Environment

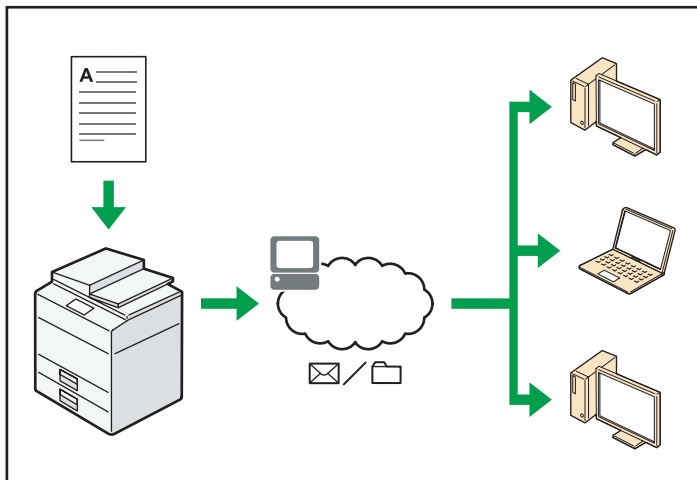

CJ0607

- You can send scan files to a specified destination using e-mail (Sending scan files by e-mail).
- You can send scan files directly to folders (Sending scan files by Scan to Folder).
- You can use this machine as a delivery scanner for the ScanRouter delivery software ^{* 1} (Network delivery scanner). You can save scan files in the delivery server or send them to a folder in a computer on the same network.
- You can use Web Services on Devices (WSD) to send scan files to a client computer.

* 1 The ScanRouter delivery software is no longer available for sale.

Reference

- See Fax , Scan , or Connecting the Machine/ System Settings .

You Can Prevent Information Leakage (Security Functions)

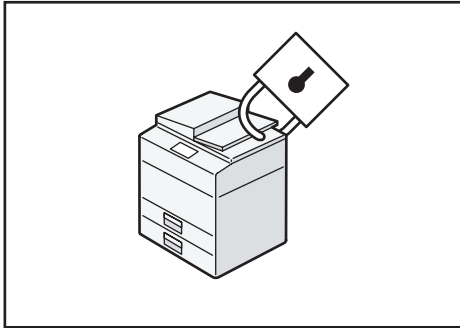

CJG608

- You can protect documents from unauthorized access and stop them from being copied without permission.
- You can control the use of the machine, as well as prevent machine settings from being changed without authorization.
- By setting passwords, you can prevent unauthorized access via the network.
- You can erase or encrypt the data on the hard disk to prevent the information from leaking out.
- You can limit the volume of the usage of the machine for each user.

Reference

- See Security Guide .

You Can Monitor and Set the Machine Using a Computer

1

Using Web Image Monitor, you can check the machine's status and change the settings.

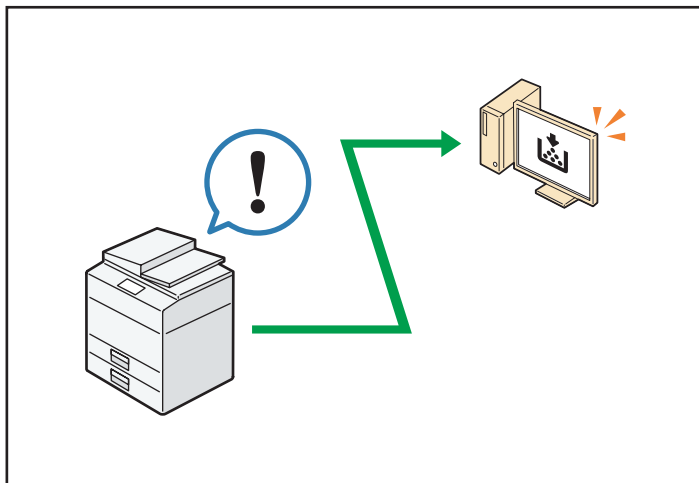

CJ0609

You can check which tray is running out of paper, register information in the Address Book, specify the network settings, configure and change the system settings, manage jobs, print the job history, and configure the authentication settings.

Reference

- See [Connecting the Machine/ System Settings](#)  or [Web Image Monitor Help](#).

You Can Prevent an Unauthorized Copy

You can print embedded pattern on paper to prevent them from being copied.

1

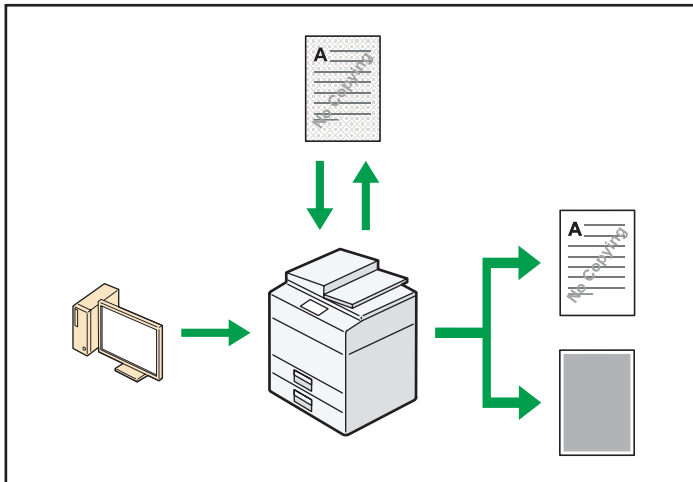

CJ0613

- Using the printer driver, you can embed a pattern in the printed document. If the document is copied on a machine with the Copy Data Security unit, protected pages are grayed out in the copy, preventing confidential information from being copied. Protected fax messages are grayed out before being transmitted or stored. If a document protected by unauthorized copy guard is copied on a machine that is equipped with the Copy Data Security unit, the machine beeps to notify users that unauthorized copying is being attempted.

If the document is copied on a machine without the Copy Data Security Unit, the hidden text becomes conspicuous in the copy, showing that the copy is unauthorized.

- Using the printer driver, you can embed text in the printed document for unauthorized copy prevention. If the document is copied, scanned, or stored in a Document Server by a copier or multifunction printer, the embedded text appears conspicuous in the copy, discouraging such unauthorized copying.

Reference

- For details, see the printer driver Help, Print , and Security Guide .

2. Getting Started

This chapter describes how to start using this machine.

Guide to Names and Functions of Components

2

Guide to Components Region A (mainly Europe)

Important

- Do not obstruct the ventilation holes by placing objects near them or leaning things against them. If the machine overheats, a fault might occur.

Front and left view

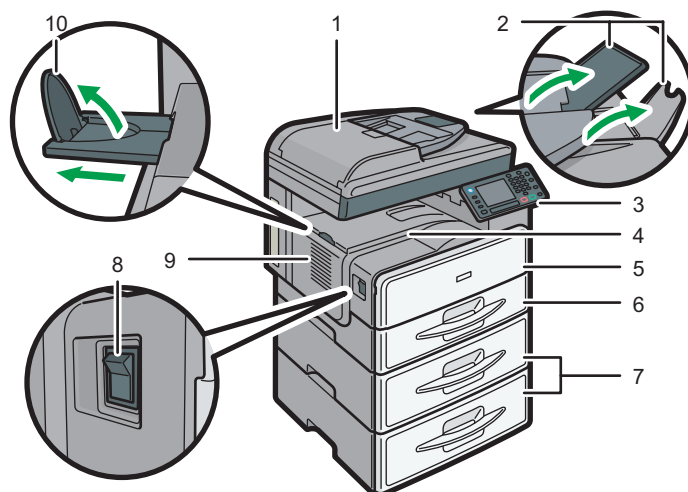

CMR001

1. Exposure glass cover or ADF

(The illustration shows the ADF.)

Lower the exposure glass cover or the ADF over originals placed on the exposure glass.

If you load a stack of originals in the ADF, the ADF will automatically feed the originals one by one.

2. Extenders

Raise these extenders to support large paper.

3. Control panel

See p.35 "Guide to the Names and Functions of the Machine's Control Panel".

4. Internal tray

Copied/printed paper and fax messages are delivered here.

5. Front cover

Open to access the inside of the machine.

6. Paper tray

Load paper here.

7. Paper tray unit (Tray 2 and Tray 3)

Load paper here.

8. Main power switch

To operate the machine, the main power switch must be on. If it is off, turn the switch on.

9. Ventilation holes

Prevent overheating.

10. Internal tray guide

Open out and raise the end fence to support large paper.

Front and right view

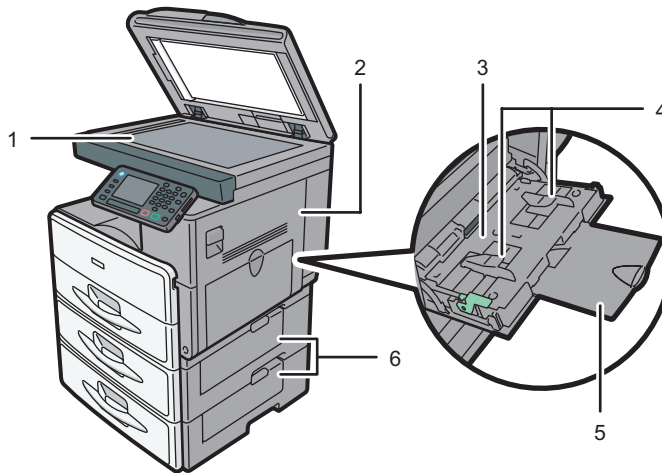

CMR002

1. Exposure glass

Place originals face down here.

2. Right cover

Open this cover to remove jammed paper fed from the paper tray.

3. Bypass tray

Use to copy or print on OHP transparencies and label paper (adhesive labels).

4. Paper guides

When loading paper in the bypass tray, align the paper guides flush against the paper.

5. Extender

Pull this extender out when loading paper in the bypass tray.

6. Lower right cover

Open this cover when a paper jam occurs.

Rear and left view

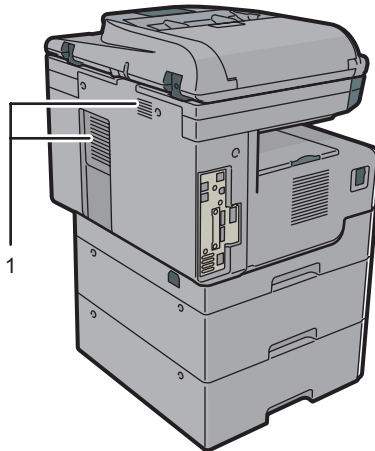

2

1. Ventilation holes

Prevent overheating.

CMR016

Guide to Components Region A (mainly Asia)

Important

- Do not obstruct the ventilation holes by placing objects near them or leaning things against them. If the machine overheats, a fault might occur.

Front and left view

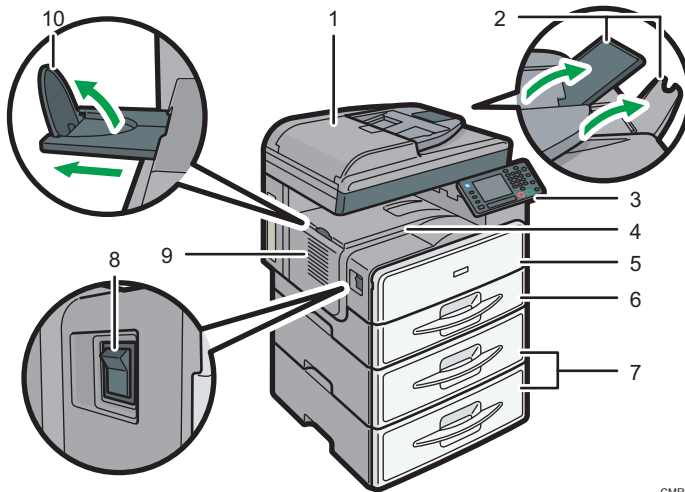

CMR001

1. ADF

Lower the ADF over originals placed on the exposure glass.

If you load a stack of originals in the ADF, the ADF will automatically feed the originals one by one.

2. Extenders

Raise these extenders to support large paper.

3. Control panel

See p.35 "Guide to the Names and Functions of the Machine's Control Panel".

4. Internal tray

Copied/printed paper and fax messages are delivered here.

5. Front cover

Open to access the inside of the machine.

6. Paper tray

Load paper here.

7. Paper tray unit (Tray 2 and Tray 3)

Load paper here.

8. Main power switch

To operate the machine, the main power switch must be on. If it is off, turn the switch on.

9. Ventilation holes

Prevent overheating.

10. Internal tray guide

Open out and raise the end fence to support large paper.

Front and right view

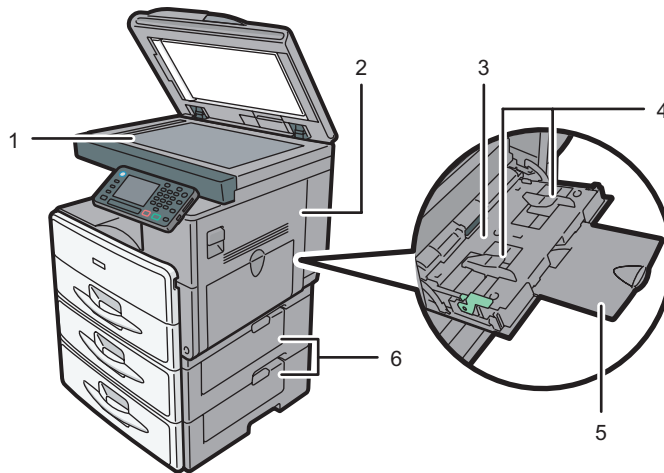

CMR002

1. Exposure glass

Place originals face down here.

2. Right cover

Open this cover to remove jammed paper fed from the paper tray.

3. Bypass tray

Use to copy or print on OHP transparencies and label paper (adhesive labels).

4. Paper guides

When loading paper in the bypass tray, align the paper guides flush against the paper.

5. Extender

Pull this extender out when loading paper in the bypass tray.

6. Lower right cover

Open this cover when a paper jam occurs.

Rear and left view

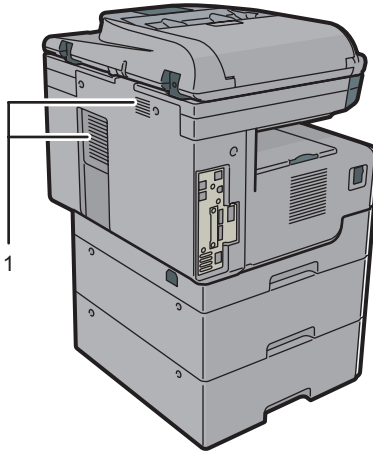

CMR016

1. Ventilation holes

Prevent overheating.

Guide to Components Region **B** (mainly North America)

Important

- Do not obstruct the ventilation holes by placing objects near them or leaning things against them. If the machine overheats, a fault might occur.

Front and left view

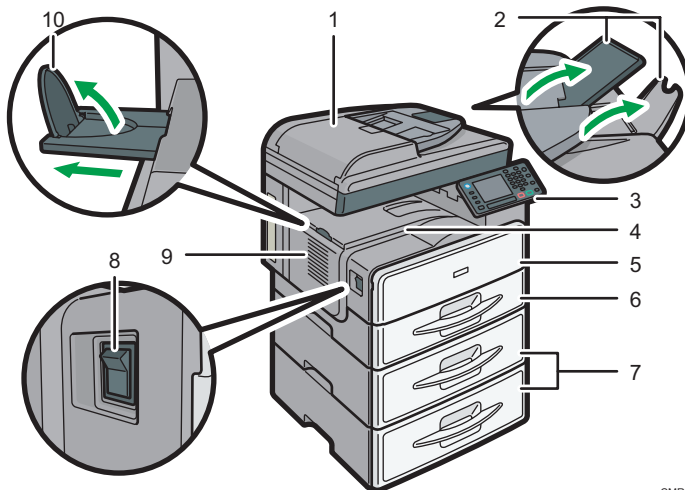

CMR001

1. ADF

Lower the ADF over originals placed on the exposure glass.

If you load a stack of originals in the ADF, the ADF will automatically feed the originals one by one.

2. Extenders

Raise these extenders to support large paper.

3. Control panel

See p.35 "Guide to the Names and Functions of the Machine's Control Panel".

4. Internal tray

Copied/printed paper and fax messages are delivered here.

5. Front cover

Open to access the inside of the machine.

6. Paper tray

Load paper here.

7. Paper tray unit (Tray 2 and Tray 3)

Load paper here.

8. Main power switch

To operate the machine, the main power switch must be on. If it is off, turn the switch on.

9. Ventilation holes

Prevent overheating.

10. Internal tray guide

Open out and raise the end fence to support large paper.

Front and right view

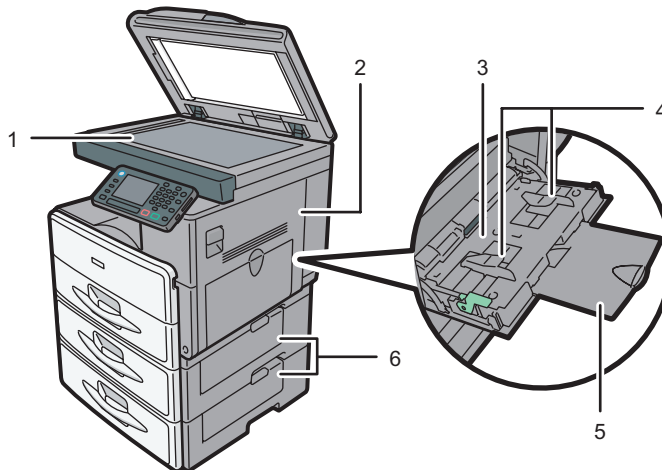

CMR002

1. Exposure glass

Place originals face down here.

2. Right cover

Open this cover to remove jammed paper fed from the paper tray.

3. Bypass tray

Use to copy or print on OHP transparencies and label paper (adhesive labels).

4. Paper guides

When loading paper in the bypass tray, align the paper guides flush against the paper.

5. Extender

Pull this extender out when loading paper in the bypass tray.

6. Lower right cover

Open this cover when a paper jam occurs.

Rear and left view

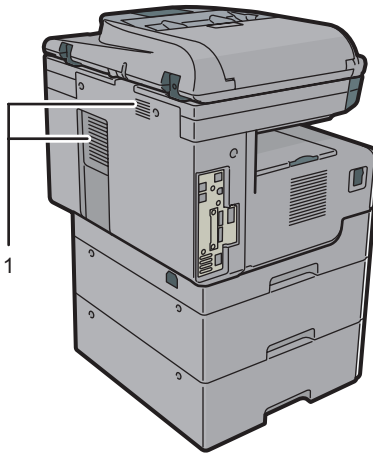

CMR016

1. Ventilation holes

Prevent overheating.

Guide to Functions of the Machine's Options

Guide to Functions of the Machine's External Options Region **A** (mainly Europe)

2

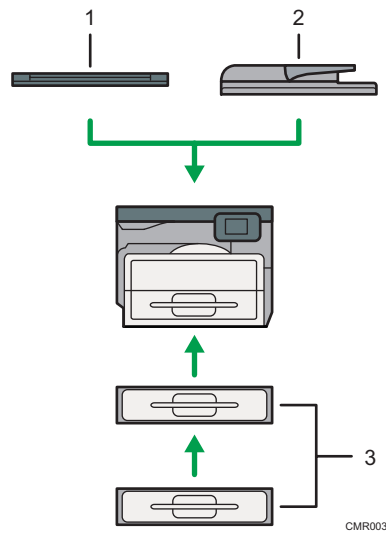

1. Exposure glass cover

Lower this cover over originals.

2. ADF

Load a stack of originals here. They will feed in automatically.

3. Paper tray unit (Tray 2 and Tray 3)

Holds up to 500 sheets of paper. Up to two trays can be stacked.

Guide to Functions of the Machine's External Options Region **A** (mainly Asia)

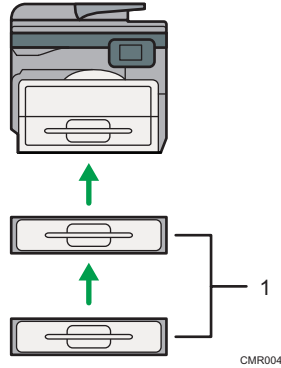

1. Paper tray unit (Tray 2 and Tray 3)

Holds up to 500 sheets of paper. Up to two trays can be stacked.

Guide to Functions of the Machine's External Options Region **B** (mainly North America)

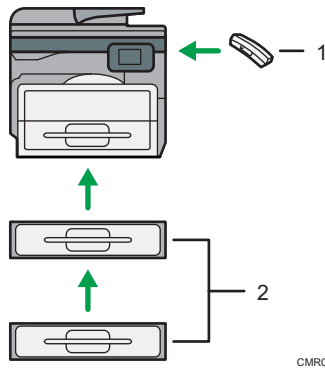

1. Handset

Used as a receiver when a fax unit is installed.

Allows you to use the On Hook Dial and Manual Dial functions. It also allows you to use the machine as a telephone.

2. Paper tray unit (Tray 2 and Tray 3)

Holds up to 500 sheets of paper. Up to two trays can be stacked.

Guide to the Names and Functions of the Machine's Control Panel

This illustration shows the control panel of the machine with options fully installed.

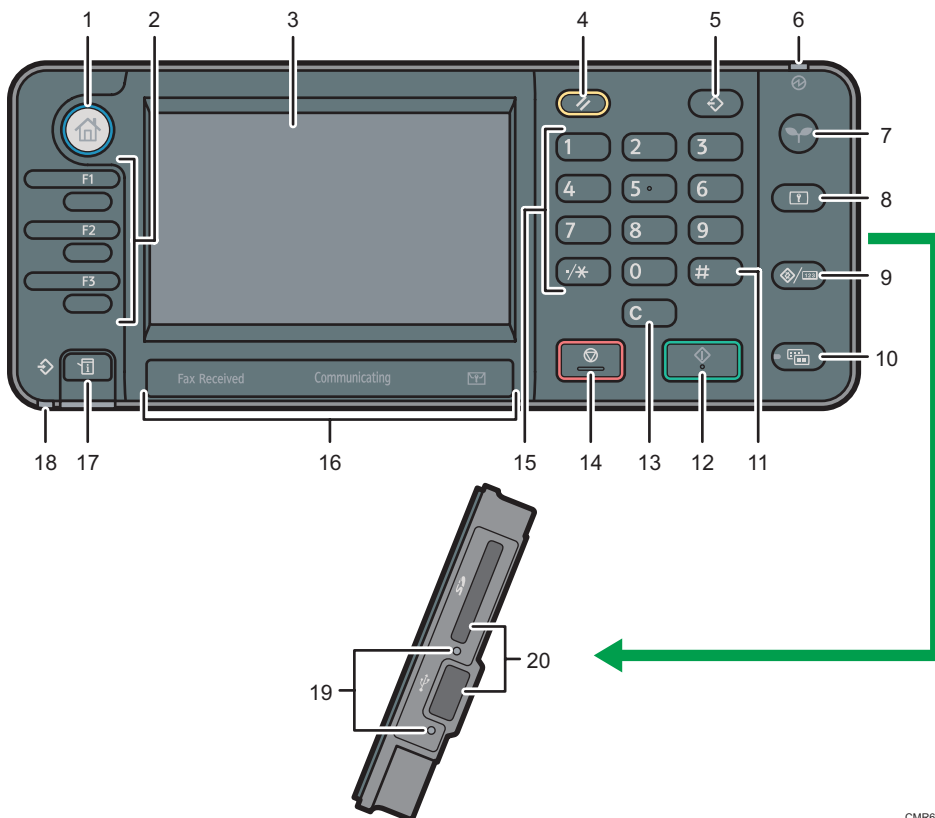

1. [Home] key

Press to display the [Home] screen. For details, see p.38 "How to Use the [Home] Screen".

2. Function keys

No functions are registered to the function keys as a factory default. You can register often used functions, programs, and Web pages. For details, see "Configuring function keys", Getting Started .

3. Display panel

Displays keys for each function, operation status, or messages. See "How to Use the Screens on the Control Panel", Getting Started .

4. [Reset] key

Press to clear the current settings.

5. [Program] key (copier, Document Server, facsimile, and scanner mode)

- Press to register frequently used settings, or to recall registered settings.

CMR606

See "Registering Frequently Used Functions", Convenient Functions .

- Press to program defaults for the initial display when modes are cleared or reset, or immediately after the main power switch is turned on.

See "Changing the Default Functions of the Initial Screen", Convenient Functions .

6. Main power indicator

The main power indicator goes on when you turn on the main power switch.

7. [Energy Saver] key

Press to switch to and from Sleep mode. See "Saving Energy", Getting Started . When the machine is in Sleep mode, the [Energy Saver] key flashes slowly.

8. [Login/Logout] key

Press to log in or log out.

9. [User Tools/Counter] key

- User Tools

Press to change the default settings to meet your requirements. See "Accessing User Tools", Connecting the Machine/ System Settings .

- Counter

Press to check or print the counter value. See "Counter", Maintenance and Specifications .

You can find out where to order expendable supplies and where to call when a malfunction occurs. You can also print these details. See "Checking Enquiry Using the User Tools", Maintenance and Specifications .

10. [Simple Screen] key

Press to switch to the simple screen. See "Switching Screen Patterns", Getting Started .

11. [#] key (Enter key)

Press to confirm values entered or items specified.

12. [Start] key

Press to start copying, printing, scanning, or sending.

13. [Clear] key

Press to delete a number entered.

14. [Stop] key

Press to stop a job in progress, such as copying, scanning, faxing, or printing.

15. Number keys

Use to enter the numbers for copies, fax numbers and data for the selected function.

16. Communicating indicator, Fax Received indicator, Confidential File indicator

- Communicating indicator

Lights continuously during data transmission and reception.

- Fax Received indicator

Lights continuously while data other than personal box or Memory Lock file is being received and stored in the fax memory.

See "Substitute Reception", Fax .

- Confidential File indicator

Lights continuously while personal box data is being received.



Blinks while Memory Lock file is being received.

See "Personal Boxes" and "Printing a File Received with Memory Lock", Fax .

17. [Check Status] key

Press to check the machine's system status, operational status of each function, and current jobs. You can also display the job history and the machine's maintenance information.

18. Data In indicator (facsimile and printer mode)

Flashes when the machine is receiving print jobs or LAN-Fax documents from a computer. See Fax  and Print .

19. Media access lamp

Lights up when a removable memory device is inserted in the media slot or accessed.

20. Media slots

Use to insert an SD card or a USB memory.

How to Use the [Home] Screen

The icons of each function are displayed on the [Home] screen.

You can add shortcuts to frequently used programs or Web pages to the [Home] screen. The icons of added shortcuts appear on the [Home] screen. The programs or Web pages can be recalled easily by pressing the shortcut icons.

To display the [Home] screen, press the [Home] key.

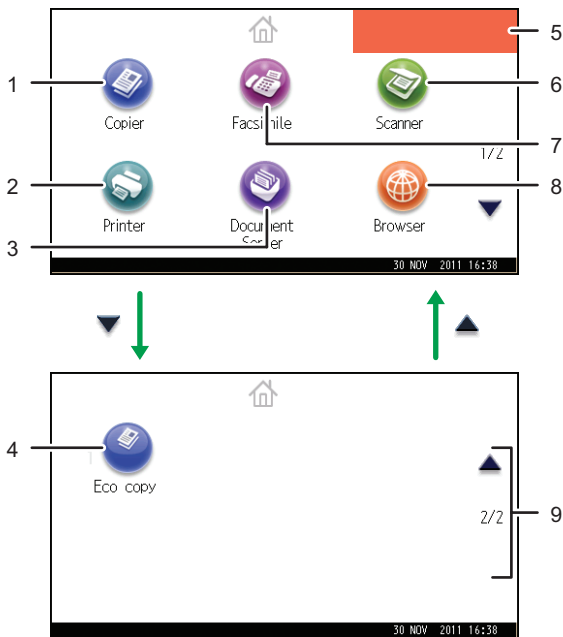

CMR615

1. [Copier]

Press to make copies.

For details about how to use the copy function, see Copy/ Document Server.

2. [Printer]

Press to make settings for using the machine as a printer.

For details about how to make settings for the printer function, see Print.

3. [Document Server]

Press to store or print documents on the machine's hard disk.

For details about how to use the Document Server function, see Copy/ Document Server.

4. Shortcut icon

You can add shortcuts to programs or Web pages to the [Home] screen. For details about how to register shortcuts, see p.39 "Adding Icons to the [Home] Screen". The program number appears on the lower left of the shortcut icon.

5. Home screen image

You can display an image on the [Home] screen, such as a corporate logo. To change the image, see "Displaying the Image on the [Home] Screen", Convenient Functions .

6. [Scanner]

Press to scan originals and save images as files.

For details about how to use the scanner function, see Scan .

7. [Facsimile]

Press to send or receive faxes.

For details about how to use the fax function, see Fax .

8. [Browser]

Press to display Web pages.

For details about how to use the browser function, see Convenient Functions .

9. ▲/▼





Press to switch pages when the icons are not displayed on one page.

Adding Icons to the [Home] Screen

You can add shortcuts to programs stored in copier, facsimile, or scanner mode, or Web pages registered in Favorites using the browser function.

You can also review icons of functions and embedded software applications that you deleted from the [Home] screen.

Note

- Shortcuts to programs stored in Document Server mode cannot be registered to the [Home] screen.
- Shortcut names of up to 32 characters can be displayed in a standard screen. If the name of the shortcut is longer than 32 characters, the 32nd character is replaced with "...". Only 30 characters can be displayed in a simple screen. If the name of the shortcut is longer than 30 characters, the 30th character is replaced with "...".
- For details about how to make a program, see p.44 "Registering Functions in a Program".
- For details about the procedure for registering Web pages to Favorites, see "Specifying the Settings for Favorites", Convenient Functions .
- Shortcuts to Web pages that are registered to Favorites by User cannot be registered to the [Home] screen. To register the shortcuts, register Web pages to Common Favorites. For details about kinds of Favorites, see "Specifying the Settings for Favorites", Convenient Functions .
- For details about the procedure for registering a shortcut using the [Program] screen, see "Registering a Shortcut to a Program to the [Home] Screen", Convenient Functions .
- You can register up to 72 function and shortcut icons. Delete unused icons if the limit is reached. For details see "Deleting an Icon on the [Home] Screen", Convenient Functions .

- You can change the position of icons. For details, see "Changing the Order of Icons on the [Home] Screen", Convenient Functions .

Adding icons to the [Home] screen using Web Image Monitor

2

1. Start Web Image Monitor.

For details, see "Using Web Image Monitor", Connecting the Machine/ System Settings .

2. Log in to Web Image Monitor as an administrator.

For details, see Security Guide .

3. Point to [Device Management], and then click [Device Home Management].

4. Click [Edit Icons].

5. Point to [+Icon can be added.] of the position that you want to add, and then click [+ Add].

6. Select the function or shortcut icon you want to add.

7. Click [OK] four times.

Adding icons to the [Home] screen using the User Tools

In the following procedure, a shortcut to a copier program is registered to the [Home] screen.

1. Register a program.

2. Press the [User Tools/Counter] key.

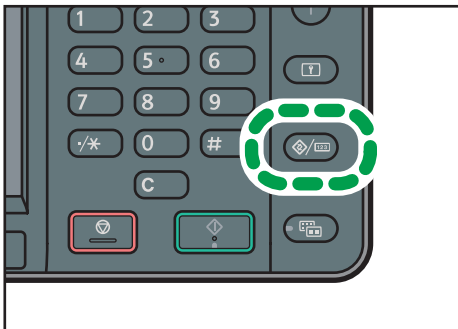

CMR633

3. Press [Edit Home].

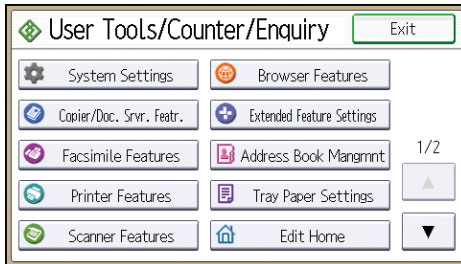

4. Press [Add Icon].

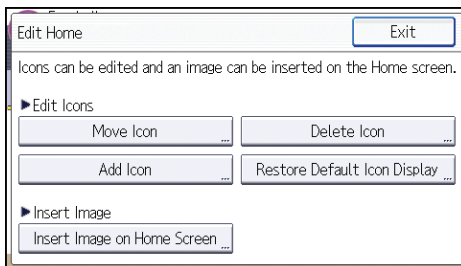

5. Press [Select Icon to Add].

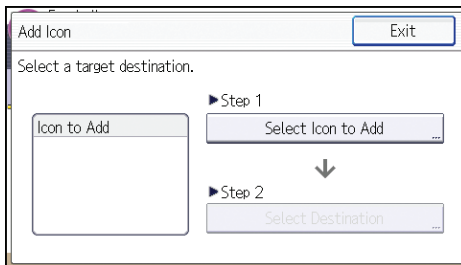

6. Press [Program].

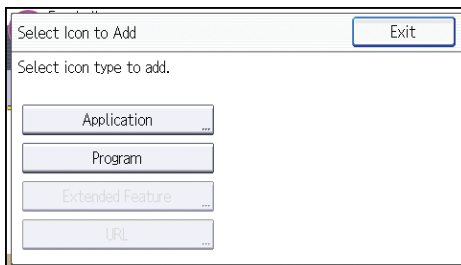

7. Press [Copier Program].

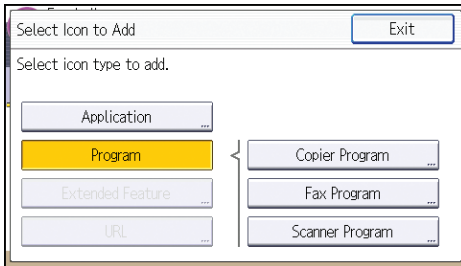

8. Select the program you want to add.

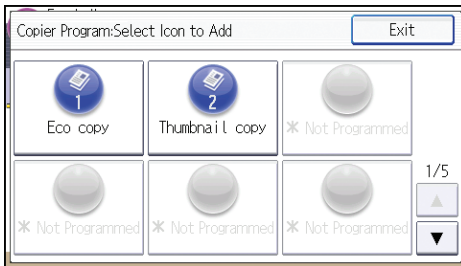

9. Press [Select Destination].

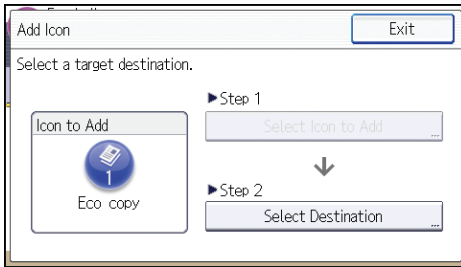

10. Specify the position where [Blank] is displayed.

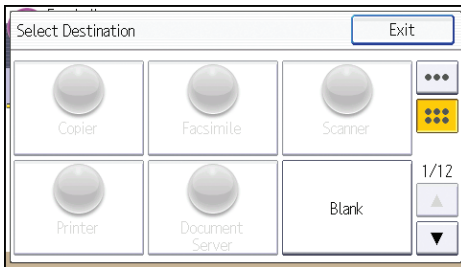

11. Press [Exit].

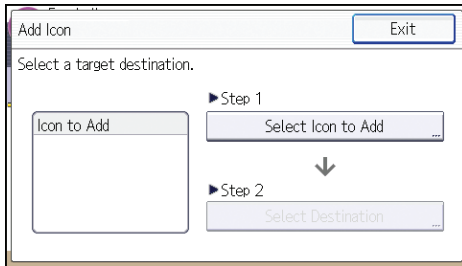

12. Press the [User Tools/Counter] key.

↓ Note

- Press [⋮] on the upper-right corner of the [Select Destination] screen to check the position on the simple screen.

Registering Functions in a Program

Depending on the functions, the number of programs that can be registered is different.

- Copier: 25 programs
- Document Server: 25 programs
- Facsimile: 100 programs
- Scanner: 25 programs

The following settings can be registered to programs:

Copier:

Density, paper tray, Orig. (Settings for Originals), Auto Reduce/Enlarge, Red./Enlg. (Reduce/Enlarge), Other Func. (Other functions), number of copies

Document Server (on the initial document print screen):

2 Sided: Top to Top, 2 Sided: Top to Bottom, Sort, Other Func. (Other functions), number of prints

Facsimile:

Transmission type, memory transmission/immediate transmission, Select Destination from Address Book (except for folder destinations), Manual Entry, TX Status Report, Send Settings (except for Subject and Sender Name)

Scanner:

Original, Send Settings (except for File Name, Security Settings in File Type, Sender Name, and User Name and Password in Store File)

This section explains how to register functions in a program using copier function as an example.

1. Press the [Home] key on the top left of the control panel, and press the [Copier] icon on the [Home] screen.

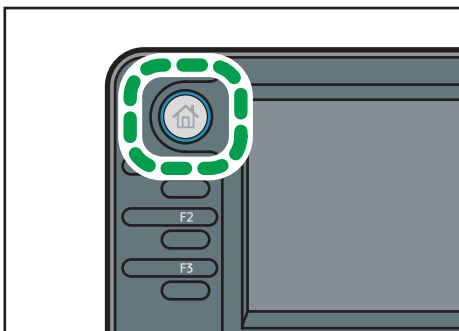

CMR612

2. Edit the copy settings so all functions you want to store in a program are selected.

3. Press the [Program] key.

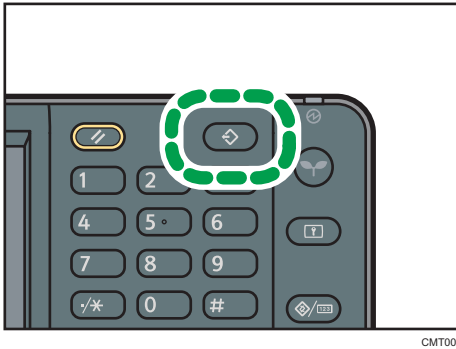

CMT001

4. Press [Program].

5. Press the program number you want to register.

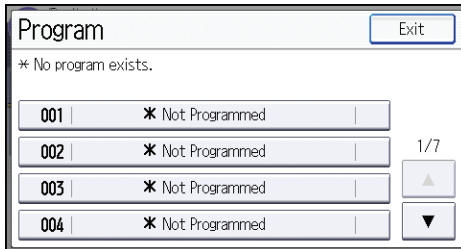



6. Enter the program name.

7. Press [OK].

8. Press [Exit] twice.

↓ Note

- The number of characters you can enter for a program name varies depending on the functions as follows:
 - Copier: 34 characters
 - Document Server: 34 characters
 - Facsimile: 20 characters
 - Scanner: 34 characters
- When a specified program is registered as the default, its values become the default settings, which are displayed without pressing the [Program] key, when modes are cleared or reset, and after the machine is turned on. See "Changing the Default Functions of the Initial Screen", Convenient Functions (📖).
- When the paper tray you specified in a program is empty and if there is more than one paper tray with the same size paper in it, the paper tray prioritized under [Paper Tray Priority: Copier] or [Paper Tray Priority: Facsimile] in the [Tray Paper Settings] tab will be selected first. For details, see "System Settings", Connecting the Machine/ System Settings (📖).

- Programs are not deleted by turning the power off or by pressing the [Reset] key unless the program is deleted or overwritten.
- Program numbers with  next to them already have settings made for them.
- Programs can be registered to the [Home] screen, and can be recalled easily. For details, see "Registering a Shortcut to a Program to the [Home] Screen", Convenient Functions  and p.39 "Adding Icons to the [Home] Screen". Shortcuts to programs stored in Document Server mode cannot be registered to the [Home] screen.

Example of Programs

Copier mode

Program name	Program description	Effect
Eco copy	Specify [Cmb. 2 Sides] under [Combine] in [Other Func.].	You can save paper and toner.
Thumbnail copy	Specify [Cmb. 1 Side] under [Combine] in [Other Func.].	You can copy up to four pages onto one side of a sheet, so that you can save paper.

Scanner mode

Program name	Program description	Effect
Easy PDF scan	In [Send Settings], select [Full Colour] under [Type of Original], and select [PDF] under [File Type]. Then enter the business details such as "London branch: daily report" under [File Name].	You can scan documents efficiently.
High compression PDF scan	In [Send Settings], select [Full Colour] under [Type of Original] and [High Compress. PDF] under [File Type].	You can compress the data size of scanned documents, so that you can send and store them.
Long-term storage scan	Select [PDF/A] under [File Type] in [Send Settings].	You can easily digitize documents to "PDF/A" file format, which is suitable for long-term storage.

Program name	Program description	Effect
Digital signature scan	In [Send Settings], specify [PDF], [High Compress. PDF], or [PDF/A] in [File Type], and also specify [Digital Signature].	You can add a digital signature to an important document such as a contract, so that any data tampering can be detected.
Dividing file scan	Specify [Divide] in [Send Settings].	You can scan a multiple page original as one file by splitting it into groups of a specified number of pages.
High resolution scan	Specify settings to save scanned data in TIFF format. Also, specify a higher resolution under [Resolution] in [Send Settings].	Scanned documents maintain much of the detail of the originals, but the size of the data may be quite large.
Batch document scan	Select [Batch] in [Send Settings].	You can apply multiple scans to a large volume of originals and send the scanned originals.

Facsimile mode

Program name	Program description	Effect
Transmission result notification fax	Select [Preview] and specify [Email TX Results] in [Send Settings].	You can check whether the transmission settings are correct before and after transmission.
Specified time fax transmission	Specify [Send Later] in [Send Settings].	You can send a fax at a specified time.
Departmental fax transmission	Specify [Fax Header Print] under [Option Setting] in [Send Settings].	This setting can be used if the receiver specifies forwarding destinations by senders.

↓ Note

- Depending on the options installed, some functions cannot be registered. For details, see "Functions Requiring Optional Configurations", Getting Started .
- The names of programs given above are just examples. You can assign any name to a program according to your objectives.
- Depending on your business details or the type of documents to be scanned, registering a program cannot be recommended.

Turning On/Off the Power

The main power switch is on the left side of the machine. Turning off this switch makes the main power indicator on the right side of the control panel go off. When this is done, machine power is off. When the fax unit is installed, fax files in memory may be lost if you turn this switch off. Use this switch only when necessary.

Turning On the Main Power

★ Important

- Do not turn off the main power switch immediately after turning it on. Doing so may result in damage to the hard disk or memory, leading to malfunctions.
1. Make sure the power cord is firmly plugged into the wall outlet.
 2. Turn on the main power switch.

The main power indicator goes on.

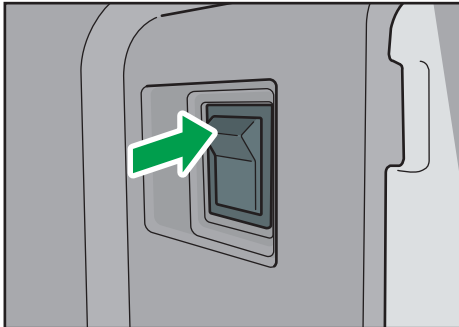

CMR010

Turning Off the Main Power

⚠ CAUTION

- When disconnecting the power cord from the wall outlet, always pull the plug, not the cord. Pulling the cord can damage the power cord. Use of damaged power cords could result in fire or electric shock.

★ Important

- After turning the machine's power off, wait at least a few seconds before turning it back on. If the message "Turn main Power Switch off" appears, turn the machine's power off, wait 10 seconds or more, and then turn it back on again. Never turn the power back on immediately after turning it off.

- Before unplugging the power cord plug, turn off the main power switch and make sure the main power switch indicator turns off. Not doing so may result in damage to the hard disk or memory, leading to malfunctions.
- Do not turn off the power while the machine is in operation.

1. Turn off the main power switch.

The main power indicator goes out.

When the Authentication Screen is Displayed

If Basic Authentication, Windows Authentication, LDAP Authentication, or Integration Server Authentication is active, the authentication screen appears on the display. The machine only becomes operable after entering your own Login User Name and Login Password. If User Code Authentication is active, you cannot use the machine until you enter the User Code.

If you can use the machine, you can say that you are logged in. When you go out of the operable state, you can say that you are logged out. After logging in the machine, be sure to log out of it to prevent unauthorized usage.

★ Important

- Ask the user administrator for the Login User Name, Login Password, and User Code. For details about user authentication, see Security Guide .
- User Code to enter on User Code Authentication is the numerical value registered in the Address Book as "User Code".

User Code Authentication Using the Control Panel

This section explains the procedure for logging in to the machine using the control panel while User Code Authentication is active.

If User Code Authentication is active, a screen prompting you to enter a User Code appears.

1. Enter a User Code (up to eight digits), and then press [OK].

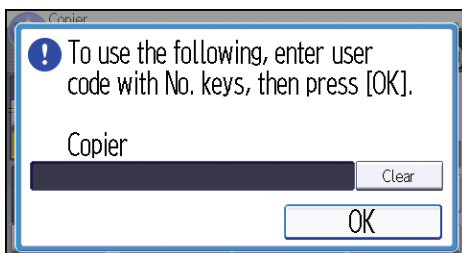

Logging In Using the Control Panel

This section explains the procedure for logging in to the machine when Basic Authentication, Windows Authentication, LDAP Authentication, or Integration Server Authentication is set.

1. Press [Login].



2. Enter a Login User Name, and then press [OK].

3. Enter a Login Password, and then press [OK].

When the user is authenticated, the screen for the function you are using appears.

Logging Out Using the Control Panel

This section explains the procedure for logging out the machine when Basic Authentication, Windows Authentication, LDAP Authentication, or Integration Server Authentication is set.

★ Important

- To prevent use of the machine by unauthorized persons, always log out when you have finished using the machine.

1. Press the [Login/Logout] key.



CMR636

2. Press [Yes].

Placing Originals

Placing Originals on the Exposure Glass Region **A** (mainly Europe)

 **Important**

- Do not lift the ADF forcefully. Otherwise, the cover of the ADF might open or be damaged.
1. Lift the ADF or the exposure glass cover.
 2. Place the original face down on the exposure glass. The original should be aligned to the rear left corner.

Start with the first page to be scanned.

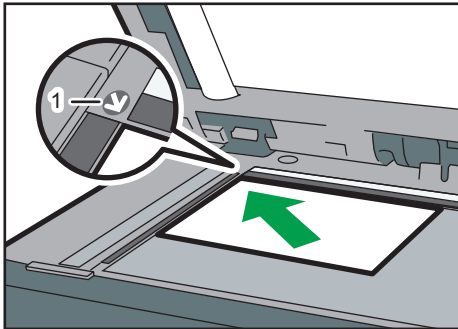

CMS001

1. Positioning mark
3. Lower the ADF or the exposure glass cover.

Placing Originals on the Exposure Glass Region **A** (mainly Asia)

 **Important**

- Do not lift the ADF forcefully. Otherwise, the cover of the ADF might open or be damaged.
1. Lift the ADF.
 2. Place the original face down on the exposure glass. The original should be aligned to the rear left corner.

Start with the first page to be scanned.

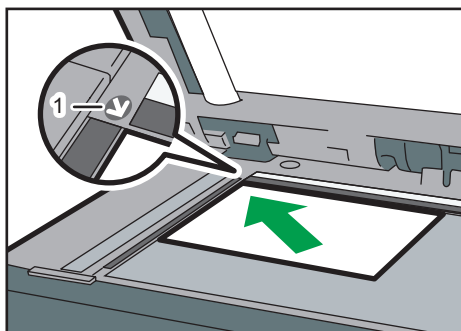

CMS001

1. Positioning mark
3. Lower the ADF.

Placing Originals on the Exposure Glass Region B (mainly North America)

★ Important

- Do not lift the ADF forcefully. Otherwise, the cover of the ADF might open or be damaged.
1. Lift the ADF.
 2. Place the original face down on the exposure glass. The original should be aligned to the rear left corner.

Start with the first page to be scanned.

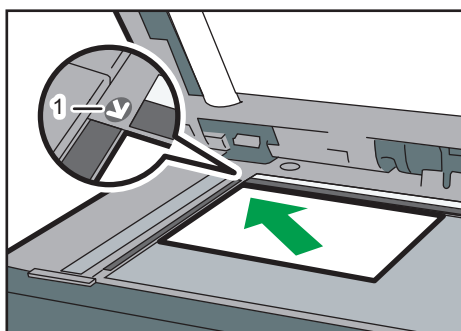

CMS001

1. Positioning mark
3. Lower the ADF.

Placing Originals in the Auto Document Feeder

Be sure not to load the original untidily. Doing so may cause the machine to display a paper misfeed message. Also, be sure not to place originals or other objects on the top cover. Doing so may cause a malfunction.

2

1. Adjust the original guides to the original size.
2. Place the aligned originals squarely face up in the ADF.

Do not stack originals beyond the limit mark.

The first page should be on the top.

When placing originals that are longer than A4 or $8\frac{1}{2} \times 11$, open the extenders.

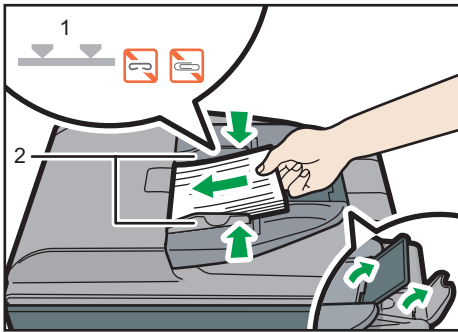

CMS003

1. Limit mark
2. Original guides

3. Copy

This chapter describes frequently used copier functions and operations. For the information not included in this chapter, see Copy/ Document Server  on the supplied CD-ROM.

Basic Procedure

To make copies of originals, place them on the exposure glass or in the ADF.

When placing the original on the exposure glass, start with the first page to be copied. When placing the original in the ADF, place them so that the first page is on the top.

 **Region A** (mainly Europe)

About placing the original on the exposure glass, see p.52 "Placing Originals on the Exposure Glass  **Region A** (mainly Europe)".

 **Region A** (mainly Asia)

About placing the original on the exposure glass, see p.52 "Placing Originals on the Exposure Glass  **Region A** (mainly Asia)".

 **Region B** (mainly North America)

About placing the original on the exposure glass, see p.53 "Placing Originals on the Exposure Glass  **Region B** (mainly North America)".

About placing the original in the ADF, see p.54 "Placing Originals in the Auto Document Feeder".

To copy onto paper other than plain paper, specify the paper type in User Tools according to the weight of the paper you are using. For details, see "System Settings", Connecting the Machine/ System Settings .

The following procedure explains copying onto paper whose size and orientation matches that of the originals exactly.

1. Press the [Home] key on the top left of the control panel, and press the [Copier] icon on the [Home] screen.

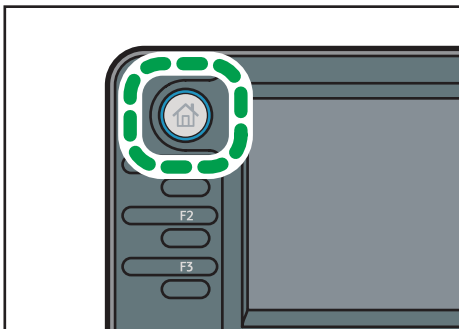

CMR612

2. Make sure no previous settings remain.

When there are previous settings remaining, press the [Reset] key.

3. Select the paper tray containing the paper that is the same size and orientation as the originals.

4. Make sure that [Use Paper Tray Settg] is selected.

When [Use Paper Tray Settg] is selected, the paper size and orientation of the tray you have selected will appear in [Orig.].

5. Place the originals.

6. Make desired settings.

7. Enter the number of copies with the number keys.

The maximum copy quantity that can be entered is 99.

8. Press the [Start] key.

When placing the original on the exposure glass, press the [#] key after all originals are scanned. Some functions such as Batch mode may require that you press the [#] key when placing originals in the ADF. Follow the messages that appear on screen.

9. When the copy job is finished, press the [Reset] key to clear the settings.

Auto Reduce/Enlarge

The machine automatically calculates the reproduction ratio based on the sizes of the originals and the paper you have specified. The machine will rotate, enlarge, or reduce the image of the originals to fit them to the paper.

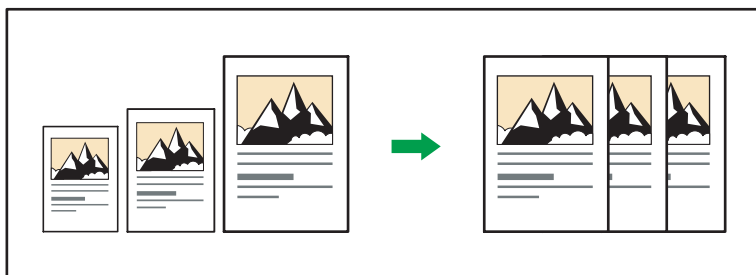

CKN008

★ Important

- You cannot use the bypass tray with this function.
- If you select a reproduction ratio after pressing [Auto Reduce/Enlarge], [Auto Reduce/Enlarge] is canceled and the image cannot be rotated automatically.

This is useful to copy different size originals to the same size paper.

If the orientation in which your original is placed is different from that of the paper you are copying onto, the machine rotates the original image by 90 degrees and fits it on the copy paper (Rotate Copy).

For example, to reduce A4 ($8\frac{1}{2} \times 11$) originals to fit onto A5 ($5\frac{1}{2} \times 8\frac{1}{2}$) paper, select a paper tray containing A5 ($5\frac{1}{2} \times 8\frac{1}{2}$) paper, and then press [Auto Reduce/Enlarge]. The image is automatically rotated.

For details about Rotate Copy, see "Rotate Copy", Copy/ Document Server .

1. Press [Orig.].

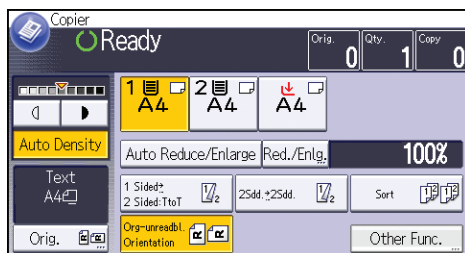

2. Press [Original's Orientation].

3. Select the original orientation, and then press [OK].

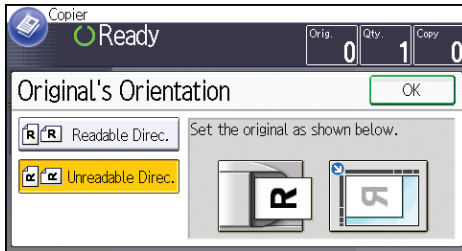

3

4. Press [Original's Size].
5. Specify the original size, and then press [OK] twice.
6. Press [Auto Reduce/Enlarge].
7. Select the paper tray.
8. Place the originals, and then press the [Start] key.

Duplex Copying

Copies two 1-sided pages or one 2-sided page onto a 2-sided page. During copying, the image is shifted to allow for the binding margin.

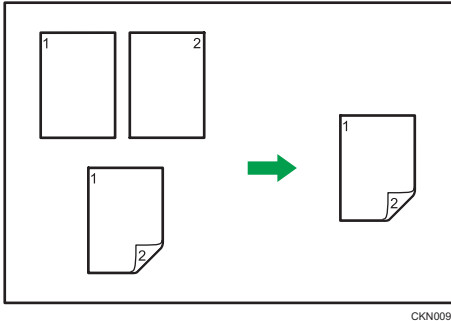

CKN009

★ Important

- You cannot use the bypass tray with this function.

There are two types of Duplex.

1 Sided → 2 Sided

Copies two 1-sided pages on one 2-sided page.

2 Sided → 2 Sided

Copies one 2-sided page on one 2-sided page.

The resulting copy image will differ according to the orientation in which you place your originals (⌂ or ☐).

Original orientation and completed copies

To copy on both sides of the paper, select the original and copy orientation according to how you want the printout to appear.

Original	Placing originals	Orig.'s Orientation	Orientation	Copy
			Top to Top	
			Top to Bottom	

Original	Placing originals	Orig.'s Orientation	Orientation	Copy
			Top to Top	
			Top to Bottom	

1. Press [Other Func.].

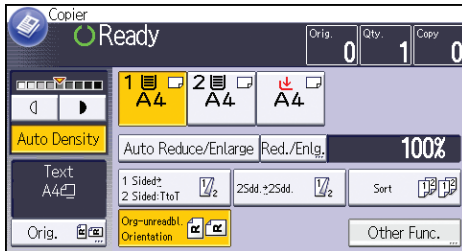

2. Press [Duplex].

3. Select [1 Sided → 2 Sided] or [2 Sided → 2 Sided] according to how you want the document to be output.

To change the original or copy orientation, press [Orientation].

To specify the original orientation is whether readable or unreadable, press [Orig.'s Orientation].

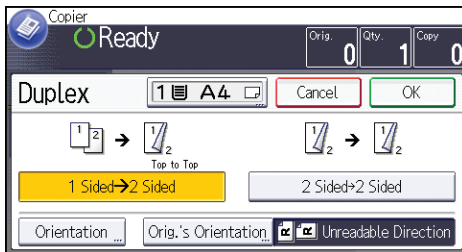

4. Press [OK] twice.

5. Select the paper tray.

6. Place the originals, and then press the [Start] key.

Specifying the Original and Copy Orientation

Select the orientation of the originals and copies if the original is two-sided or if you want to copy onto both sides of the paper.

- Top to Top

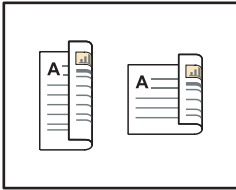

CKN011

- Top to Bottom

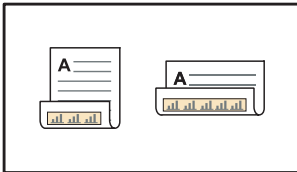

CKN012

1. Press [Orientation].
2. Select [Top to Top] or [Top to Bottom] for [Original] if the original is two-sided.

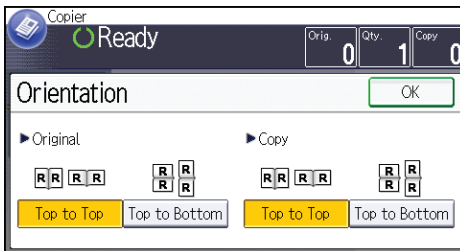

3. Select [Top to Top] or [Top to Bottom] for [Copy].
4. Press [OK].

Combined Copying

This mode can be used to select a reproduction ratio automatically and copy the originals onto a single sheet of copy paper.

The machine selects a reproduction ratio between 25 and 400%. If the orientation of the original is different from that of the copy paper, the machine will automatically rotate the image by 90 degrees to make copies properly.

Orientation of the original and image position of Combine

The image position of Combine differs according to original orientation and the number of originals to be combined.

- Portrait (📄) originals

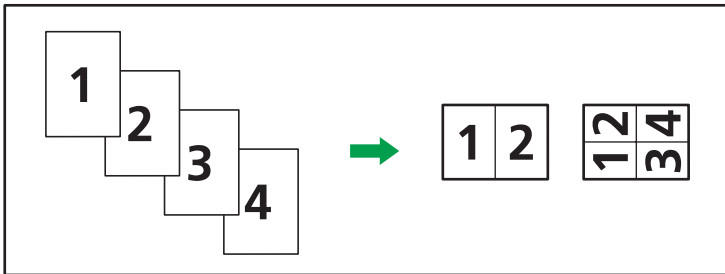

CNU005

- Landscape (📄) originals

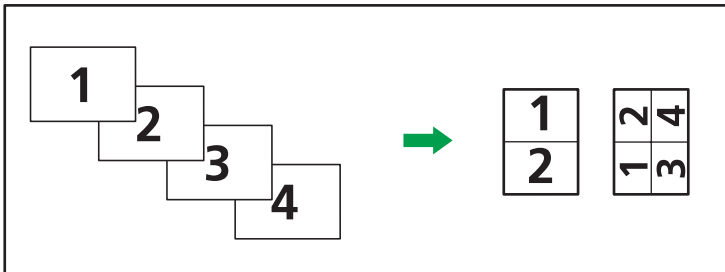

CNU006

Placing originals (originals placed in the ADF)

The default value for the copy order in the Combine function is [From Left to Right]. To copy originals from right to left in the ADF, place them upside down.

- Originals read from left to right

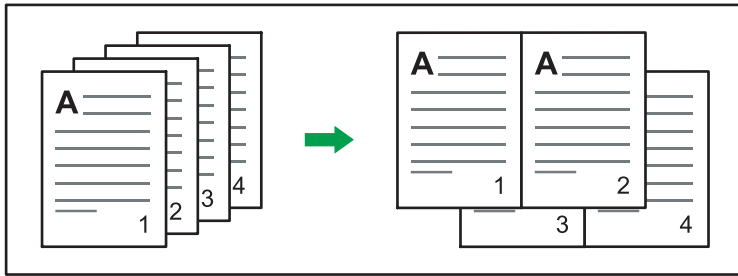

CKN010

- Originals read from right to left

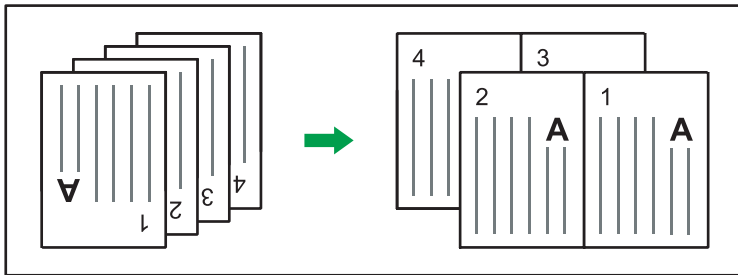

CKN017

One-Sided Combine

Combine several pages onto one side of a sheet.



CKN014

★ Important

- You cannot use the bypass tray with this function.

There are four types of One-Sided Combine.

1 Sided 2 Originals → Cmb. 1 Side

Copies two 1-sided originals to one side of a sheet.

1 Sided 4 Originals → Cmb. 1 Side

Copies four 1-sided originals to one side of a sheet.

2 Sided 2 Pages → Cmb. 1 Side

Copies one 2-sided original to one side of a sheet.

2 Sided 4 Pages → Cmb. 1 Side

Copies two 2-sided originals to one side of a sheet.

1. Press [Orig.].

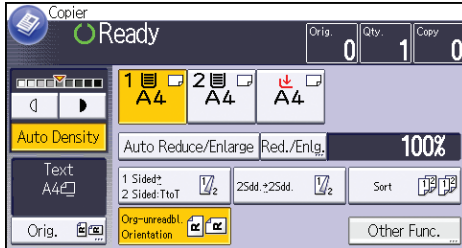

2. Press [Original's Size].

3. Specify the original size, and then press [OK] twice.

4. Press [Other Func.].

5. Press [Combine].

6. Select [1 Sided] or [2 Sided] for [Original].

If you selected [2 Sided], you can change the orientation by pressing [Orientation].

To specify the original orientation is whether readable or unreadable, press [Orig.'s Orientation].

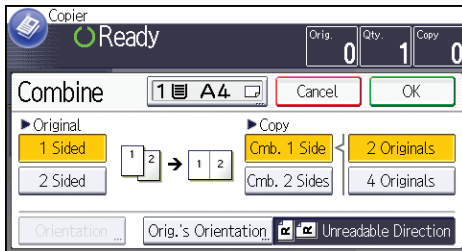

7. Press [Cmb. 1 Side].

8. Select the number of originals to combine.

9. Press [OK] twice.

10. Select the paper tray.

11. Place the originals, and then press the [Start] key.

Two-Sided Combine

Combines various pages of originals onto two sides of one sheet.

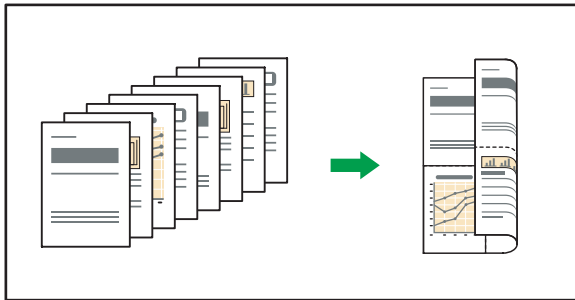

CKN074

★ Important

- You cannot use the bypass tray with this function.

There are four types of Two-Sided Combine.

1 Sided 4 Originals → Cmb. 2 Sides

Copies four 1-sided originals to one sheet with two pages per side.

1 Sided 8 Originals → Cmb. 2 Sides

Copies eight 1-sided originals to one sheet with four pages per side.

2 Sided 4 Pages → Cmb. 2 Sides

Copies two 2-sided originals to one sheet with two pages per side.

2 Sided 8 Pages → Cmb. 2 Sides

Copies four 2-sided originals to one sheet with four pages per side.

1. Press [Orig.].

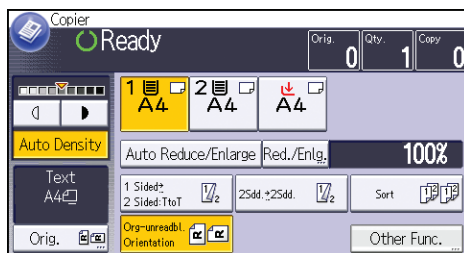

2. Press [Original's Size].

3. Specify the original size, and then press [OK] twice.

4. Press [Other Func.].

5. Press [Combine].

6. Select [1 Sided] or [2 Sided] for [Original].

To specify the original orientation is whether readable or unreadable, press [Orig.'s Orientation].

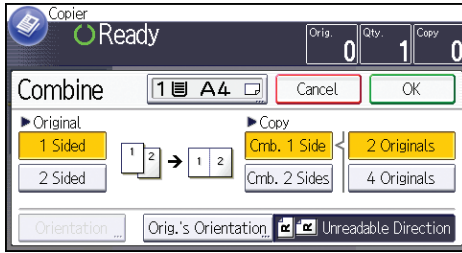

7. Press [Cmb. 2 Sides].
8. Press [Orientation].
9. Select [Top to Top] or [Top to Bottom] for [Original] and/or [Copy], and then press [OK].
10. Select the number of originals to combine.
11. Press [OK] twice.
12. Select the paper tray.
13. Place the originals, and then press the [Start] key.

Copying onto Custom Size Paper from the Bypass Tray

Paper that has a horizontal length of 139.0–600.0 mm (5.48–23.62 inches) and a vertical length of 90.0–216.0 mm (3.55–8.50 inches) can be fed in from the bypass tray.

1. Load the paper face down in the bypass tray.

The bypass tray (≡) is automatically selected.

2. Press the [#] key.

3. Press [Paper Size].

4. Press [Custom Size].

5. Enter the horizontal size with the number keys, and then press [#].

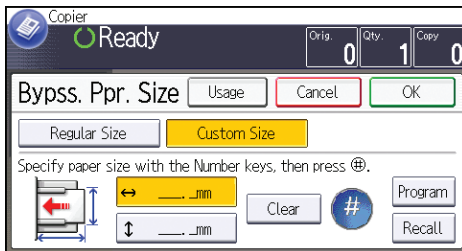

6. Enter the vertical size with the number keys, and then press [#].

7. Press [OK] twice.

8. Place the originals, and then press the [Start] key.

Copying onto Envelopes

This section describes how to copy onto regular size and custom size envelopes. Envelopes should be fed from the bypass tray.

Specify the thickness of the paper according to the weight of the envelopes you are printing on. For details about the relationship between paper weight and paper thickness and the sizes of envelopes that can be used, see p.135 "Recommended Paper Sizes and Types".

About handling envelopes, supported envelope types, and how to load envelopes, see p.139 "Envelopes".

★ Important

- **The Duplex function cannot be used with envelopes. If the Duplex function is specified, press [1 Sided → 2 Sided:ToT] to cancel the setting.**

To copy onto custom size envelopes, you must specify the envelope's dimensions. Specify the horizontal and vertical length of the envelope.

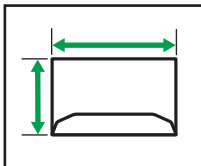
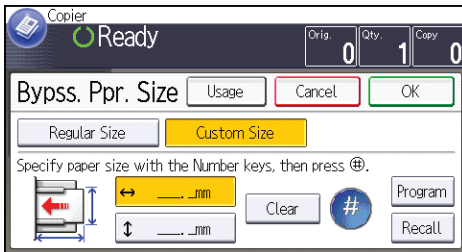

CNU004

↔: Horizontal

↕: Vertical

1. Place the original face down on the exposure glass. The original should be aligned to the rear left corner.

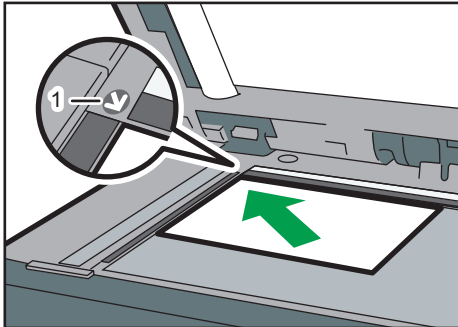

CMS001

1. Positioning mark
2. Load the envelopes face down in the bypass tray.
The bypass tray (≡) is automatically selected.
3. Press the [#] key.
4. Press [Paper Size].

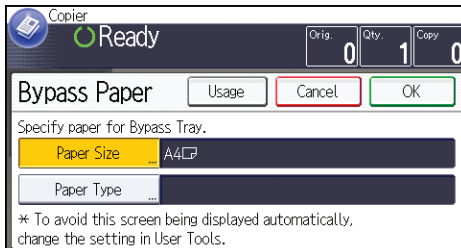

5. Specify the envelope size, and then press [OK].
6. Press [Paper Type].
7. Press [Thick Paper], and then press [OK].
8. Press [OK].
9. Press the [Start] key.

Sort

The machine assembles copies as sets in sequential order.



CKN018

Depending on which options are installed on your machine, this function might not be available. For details, see "Functions Requiring Optional Configurations", Getting Started .

1. Press [Other Func.].

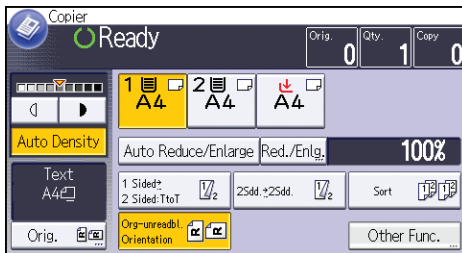

2. Press [Sort], and then press [OK].
3. Enter the number of copy sets using the number keys.
4. Select the paper tray.
5. Place the originals, and then press the [Start] key.

Changing the Number of Sets

You can change the number of copy sets during copying.

★ Important

- This function can be used only when the Sort function is selected.

1. While "Copying..." is displayed, press the [Stop] key.

2. Enter the number of copy sets with the number keys.

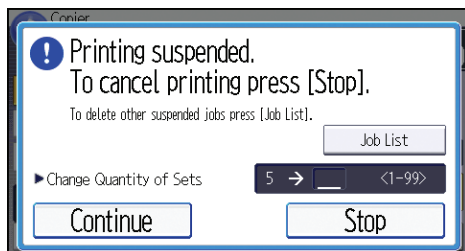

3. Press [Continue].

Copying starts again.

Storing Data in the Document Server

The Document Server enables you to store documents being read with the copy feature on the hard disk of this machine. Thus you can print them later applying necessary conditions.

You can check the stored documents from the Document Server screen. For details about the Document Server, see p.115 "Storing Data".

Depending on which options are installed on your machine, this function might not be available. For details, see "Functions Requiring Optional Configurations", Getting Started .

3

1. Press [Other Func.].

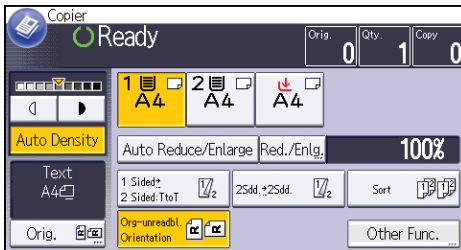

2. Press [▼].
3. Press [Store File].
4. Enter a file name, user name, or password if necessary.
5. Press [OK] twice.
6. Select the paper tray.
7. Place the originals.
8. Make the scanning settings for the original.
9. Press the [Start] key.

Stores scanned originals in memory and makes one set of copies. If you want to store another document, do so after copying is complete.

4. Fax

This chapter describes frequently used facsimile functions and operations. For the information not included in this chapter, see Fax ⓘ on the supplied CD-ROM.

Basic Procedure for Transmissions (Memory Transmission)

This section describes the basic procedure for transmitting documents using Memory Transmission. You can specify the fax, IP-Fax, Internet Fax, e-mail, or folder destinations. Multiple types of destination can be specified simultaneously.

★ Important

- It is recommended that you call the receivers and confirm with them when sending important documents.
- If there is a power failure (the main power switch is turned off) or the machine is unplugged for about 12 hours, all the documents stored in memory are deleted. As soon as the main power switch is turned on, the Power Failure Report is printed to help you check the list of deleted files. See "Turning Off the Main Power / In the Event of Power Failure", Troubleshooting ⓘ.

1. Press the [Home] key on the top left of the control panel, and press the [Facsimile] icon on the [Home] screen.

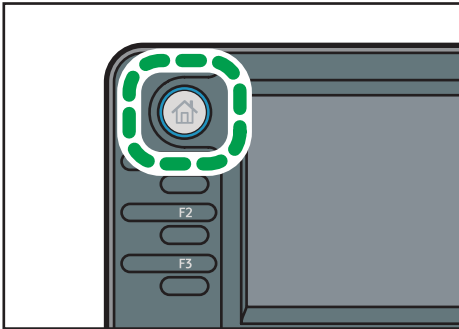

CMR612

2. Make sure "Ready" appears on the screen.

3. Make sure [Immed. TX] is not highlighted.

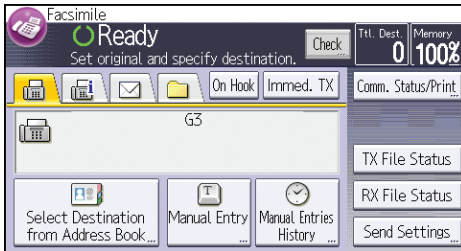

4. Place the original into the ADF.

5. Configure the scan and transmission settings in "Send Settings".

6. Specify a destination.

You can enter the destination's number or address directly or select from the Address Book by pressing the destination key.

If you make a mistake, press the [Clear] key, and then enter again.

7. When sending the same original to several destinations (broadcasting), specify the next destination.

8. If you send documents to Internet Fax or e-mail destinations or enable the "Email TX Results" function, specify a sender.

9. Press the [Start] key.

Sending Originals Using the Exposure Glass (Memory Transmission)

1. Make sure [Immed. TX] is not highlighted.

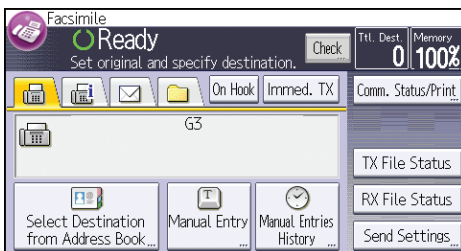

2. Place the first page of the original face down on the exposure glass.

3. Specify a destination.

4. Make the scan settings you require.

5. Press the [Start] key.

6. Place the next original on the exposure glass within 60 seconds when you send multiple originals, and then repeat steps 4 and 5.

Repeat this step for each page.

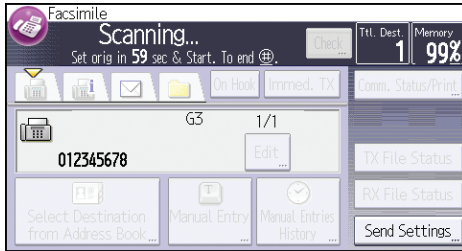

7. Press the [#] key.

The machine dials the destination and starts transmission.

Registering a Fax Destination

4

1. Press the [User Tools/Counter] key.

2. Press [Address Book Mangmnt].

3. Press [New Program].

4. Press [Names].

5. Press [Name].

The name entry display appears.

6. Enter the name, and then press [OK].

7. Press [▼] to display [Title 1], [Title 2] and [Title 3].

8. Press [Title 1], [Title 2] or [Title 3] to select the key for the classification you want to use.

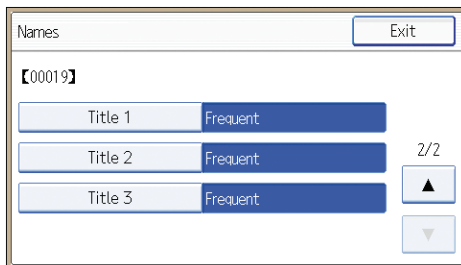

The keys you can select are as follows:

- [Frequent]: Added to the page that is displayed first.
- [AB], [CD], [EF], [GH], [IJK], [LMN], [OPQ], [RST], [UVW], [XYZ], [1] to [10]: Added to the list of items in the selected title.

You can select [Frequent] and one more key for each title.

9. Press [OK].

10. Press [Exit].

11. Press [Fax Dest.].

12. Press [Fax Destination].

13. Enter the fax number using the number keys, and then press [OK].

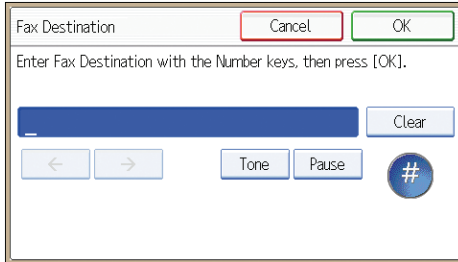

14. Specify optional settings such as "SUB Code", "SEP Code", and "International TX Mode".

To specify [SUB Code], [SEP Code], or [Sub-add./UUI], press [Adv. Features].

15. Press [OK].

16. Press [Exit].

17. Press [OK].

18. Press the [User Tools/Counter] key.

4

Deleting a Fax Destination

★ Important

- If you delete a destination that is a specified delivery destination, messages to its registered Personal Box, for example, cannot be delivered. Be sure to check the settings in the fax function before deleting any destinations.

1. Press the [User Tools/Counter] key.
2. Press [Address Book Mangmnt].
3. Press [Change].
4. Press [Fax Dest.].
5. Select the name whose fax destination you want to delete.

Press the name key, or enter the registered number using the number keys.

You can search by the registered name, user code, fax number, folder name, e-mail address, or IP-Fax destination.

6. Press [Fax Dest.].
7. Press [Fax Destination].

8. Press [Clear], and then press [OK].

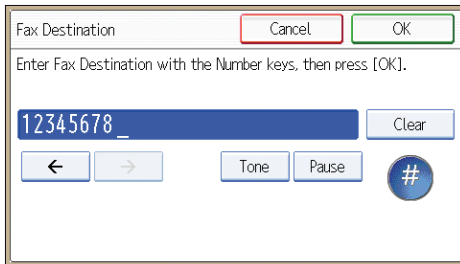

9. Press [OK].

10. Press [Exit].

11. Press [OK].

12. Press the [User Tools/Counter] key.

Transmitting while Checking Connection to Destination (Immediate Transmission)

Using Immediate Transmission, you can send documents while checking the connection to the destination.

You can specify fax or IP-Fax destinations.

If you specify Internet Fax, e-mail, folder destinations, and group or multiple destinations, the transmission mode is automatically switched to Memory Transmission.

★ Important

- It is recommended that you call the receivers and confirm with them when sending important documents.

1. Press the [Home] key on the top left of the control panel, and press the [Facsimile] icon on the [Home] screen.

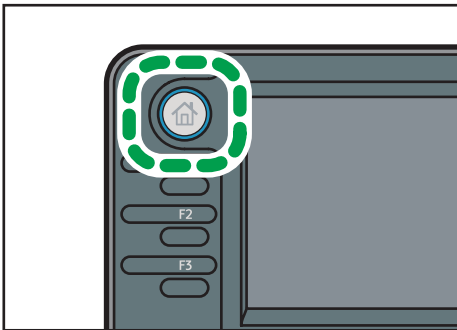

CMR612

2. Make sure "Ready" appears on the screen.
3. Press [Immed. TX].



4. Place the original into the ADF.
5. Select the scan settings you require.
6. Specify a destination.

If you make a mistake, press the [Clear] key, and then enter again.

7. Press the [Start] key.

Sending Originals Using the Exposure Glass (Immediate Transmission)

1. Press [Immed. TX].

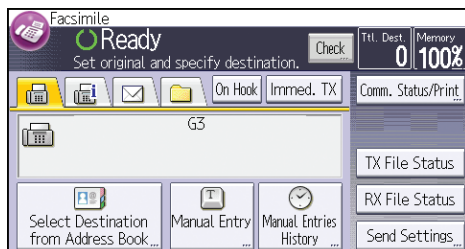

2. Place the first page face down on the exposure glass.
3. Specify a destination.
4. Make the scan settings you require.
5. Press the [Start] key.
6. Place the next original on the exposure glass within 10 seconds when you send multiple originals, and then repeat steps 4 and 5.

Repeat this step for each page.



7. Press the [#] key.

Canceling a Transmission

This section explains how to cancel a fax transmission.

Canceling a Transmission Before the Original Is Scanned

Use this procedure to cancel a transmission before pressing the [Start] key.

1. Press the [Reset] key.

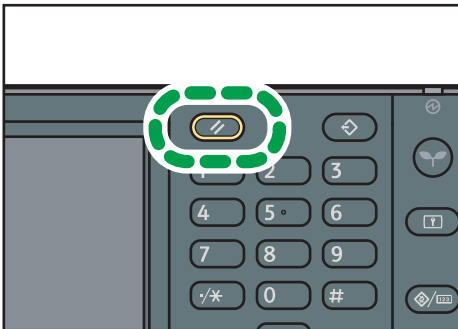

CMK001

Canceling a Transmission While the Original Is Being Scanned

Use this procedure to cancel scanning or transmitting of the original while it is being scanned.

1. Press the [Stop] key.

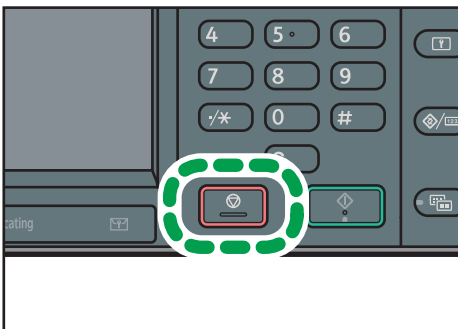

CMK002

2. Press [Cancel Scan.] or [Cancel TX].

Depending on the transmission mode and function you use, either [Cancel Scan.] or [Cancel TX] is displayed.

Canceling a Transmission After the Original Is Scanned (While a Transmission Is in Progress)

Use this procedure to delete a file that is being sent after the original is scanned.

All the scanned data is deleted from memory.

1. Press the [Stop] key.

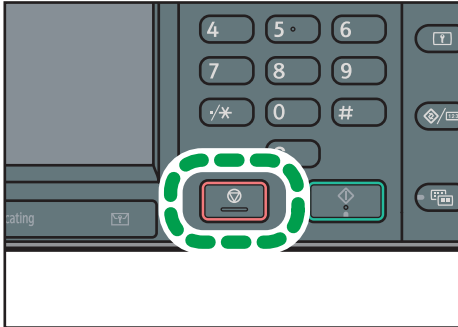

CMK002

You can also press [Comm. Status/Print], and then [Check/Stop Transmission File].

2. Press [Standby File List].
3. Select the file you want to cancel.
If the desired file is not shown, press [▲] or [▼] to find it.
4. Press [Cancel TX].
To cancel another file, repeat steps 3 through 4.
5. Press [OK].
6. Press [Exit].

After pressing [Check/Stop Transmission File] under [Comm. Status/Print] in step 1, press [Exit] twice.

Canceling a Transmission After the Original Is Scanned (Before a Transmission Is Started)

Use this procedure to delete a file stored in memory before its transmission has started.

1. Press [Comm. Status/Print].

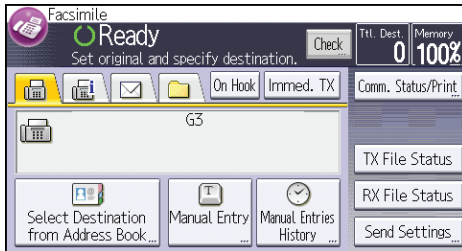

2. Press [Check/Stop Transmission File].

3. Press [Display File List].

4. Select the file you want to cancel.

If the desired file is not shown, press [▲] or [▼] to find it.

5. Press [Cancel TX].

To cancel another file, repeat steps 4 through 5.

6. Press [OK].

7. Press [Exit] three times.

Sending at a Specific Time (Send Later)

Using this function, you can instruct the machine to delay transmission of your fax document until a specified later time.

This allows you to take advantage of off-peak telephone charges without having to be by the machine at the time.

Use Memory Transmission for this function. Immediate Transmission is not possible.

★ Important

- If the machine is switched off for about 12 hours, all fax documents stored in memory are lost. If documents are lost for this reason, a Power Failure Report is automatically printed when the main power switch is turned on. Use this report to check the list of lost documents. See "Turning Off the Main Power / In the Event of Power Failure", Troubleshooting .

1. Press [Send Settings].

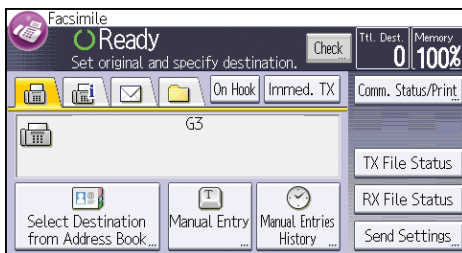

2. Press [▼], and then press [Send Later].

3. Enter the time, and then press [#].

 **Region A** (mainly Europe and Asia)

Enter the time (24 hour format) using the number keys.

 **Region B** (mainly North America)

Enter the time using the number keys, and then select [AM] or [PM].

When entering numbers smaller than 10, add a zero at the beginning.

4. Press [OK] twice.

Storing a Document

You can store and send a document at the same time. You can also just store a document.

The following information can be set for the stored documents as necessary:

User Name

You can set this function if necessary to know who and what departments stored documents in the machine. A user name can be selected from the Address Book or entered manually.

File Name

You can specify a name for a stored document. If you do not specify a name, scanned documents will be automatically assigned names such as "FAX0001" or "FAX0002".

Password

You can set this function so as not to send to unspecified people. A four to eight digit number can be specified as a password.

You can also change the file information after storing files.

1. Place the original, and then specify the scan settings you require.

Specify the "Original Orientation" setting correctly. If you do not, the top/bottom orientation of the original will not be displayed correctly in the preview.

2. Press [Send Settings].

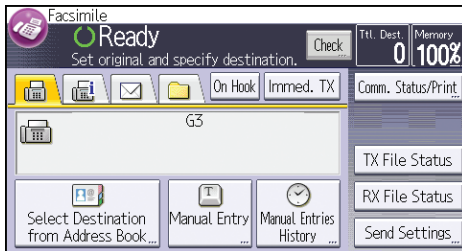

3. Press [▼] three times, and then press [Store File].

4. Select [Store to HDD] or [Store to HDD + Send].

Select [Store to HDD + Send] to send documents after they are stored.

Select [Store to HDD] to store documents.

5. Set the user name, file name, and password as necessary.

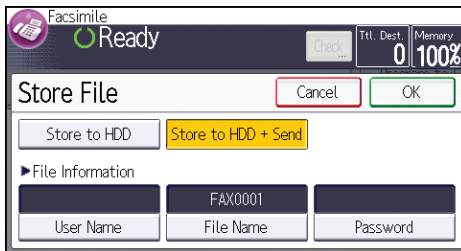

- User Name
Press [User Name], and then select a user name. To specify an unregistered user name, press [Manual Entry], and then enter the name. After specifying a user name, press [OK].
- File Name
Press [File Name], enter a file name, and then press [OK].
- Password
Press [Password], enter a password using the number keys, and then press [OK]. Re-enter the password for confirmation, and then press [OK].

6. Press [OK] twice.

7. If you have selected [Store to HDD + Send], specify the receiver.

8. Press the [Start] key.

Sending Stored Documents

The machine sends documents stored with the facsimile function in the Document Server.

The documents stored in the Document Server can be sent again and again until they are deleted.

The stored documents are sent with the scan settings made when they were stored.

You can select the following transmission methods:

Original + Stored File

The machine sends the originals, and then stored files.

Stored file + Original

The machine sends the stored files, and then originals.

This function cannot be used with the following functions:

- Immediate Transmission
- Parallel Memory Transmission
- On Hook Dial
- Manual Dial

1. Press [Send Settings].

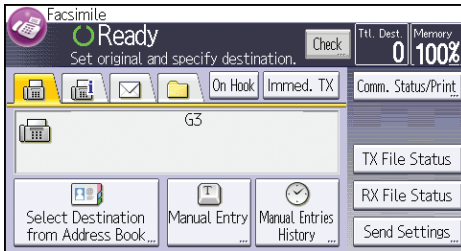

2. Press [▼] four times, and then press [Select Stored File].

3. Select the documents to be sent.

When multiple documents are selected, they are sent in the order of selection.

- Press [File Name] to place the documents in alphabetical order.
- Press [Date] to place the documents in order of programmed date.
- Press [Queue] to arrange the order of the documents to be sent.

To view details about stored documents, press [Details].

Press the Thumbnails key to switch the screen to thumbnail display.

4. If you select a document with a password, enter the password using the number keys, and then press [OK].

5. Specify "TX Method" as necessary.

Press [TX Method], select [Original + Stored File] or [Stored file + Original], and then press [OK].

6. Press [OK] twice.

7. To add an original to stored documents, place the original, and then select any scan settings you require.

8. Specify the destination, and then press the [Start] key.

Printing the Journal Manually

To print the Journal manually, select the printing method: "All", "Print per File No.", or "Print per User".

All

Prints the results of communications in the order made.

Print per File No.

Prints only the results of communications specified by file number.

Print per User

Prints the results of communications by individual senders.

1. Press [Comm. Status/Print].



2. Press [Print Journal].

3. Select the printing method.

4. If you selected "Print per File No." in step 3, enter a 4-digit file number using the number keys.
5. If you selected "Print per User" in step 3, select a user from the list, and then press [OK].
6. Press the [Start] key.
7. Press [Exit] twice.

5. Print

This chapter describes frequently used printer functions and operations. For the information not included in this chapter, see Print  on the supplied CD-ROM.

Quick Install

You can install the printer drivers easily from the CD-ROM provided with this machine.

Using Quick Install, the PCL 6 printer driver is installed under network environment, and the Standard TCP/IP port will be set.

When the machine is connected to a client computer via parallel connection, the printer port is set to [LPT1].

Important

- **Manage Printers permission is required to install the drivers. Log on as an Administrators group member.**

1. Quit all applications. (Do not close this manual.)

2. Insert the provided CD-ROM into the computer's CD-ROM drive.

If the [AutoPlay] dialog box appears, click [Run AUTORUN.EXE].

3. Select an interface language, and then click [OK].

4. Click [Quick Install].

5. The software license agreement appears in the [License Agreement] dialog box. After reading the agreement, click [I accept the agreement.], and then click [Next].

6. Select the machine model you want to use in the [Select Printer] dialog box.

For network connection via TCP/IP, select the machine whose IP address is displayed in [Connect To].

For parallel connection, select the machine whose printer port is displayed in [Connect To].

7. Click [Install].

8. Configure the user code, default printer, and shared printer as necessary.

9. Click [Continue].

The installation starts.

If the [User Account Control] dialog box appears, and then click [Yes] or [Continue].

10. Click [Finish].

When you are prompted to restart your computer, restart it by following the instructions that appear.

11. Click [Exit] in the first window of the installer, and then take out the CD-ROM.

Displaying the Printer Driver Properties

This section explains how to open the printer driver properties from [Devices and Printers].

★ Important

- **Manage Printers permission is required to change the printer settings. Log on as an Administrators group member.**
- **You cannot change the machine default settings for individual users. Settings made in the printer properties dialog box are applied to all users.**

1. On the [Start] menu, click [Devices and Printers].
2. Right-click the icon of the printer you want to use.
3. Click [Printer properties].

Standard Printing

★ Important

- The default setting is duplex printing. If you want to print on only one side, select [Off] for the duplex setting.
- If you send a print job via USB 2.0 while the machine is in Low Power mode or Sleep mode, an error message might appear when the print job is complete. In this case, check if the document was printed.

When Using the PCL 6 Printer Driver

1. Click the WordPad menu button in the upper left corner of the window, and then click [Print].
2. In the [Select Printer] list, select the printer you want to use.
3. Click [Preferences].
4. In the "Job Type:" list, select [Normal Print].
5. In the "Document Size:" list, select the size of the original to be printed.
6. In the "Orientation:" list, select [Portrait] or [Landscape] as the orientation of the original.
7. In the "Input Tray:" list, select the paper tray that contains the paper you want to print onto.
If you select [Auto Tray Select] in the "Input Tray:" list, the source tray is automatically selected according to the paper size and type specified.
8. In the "Paper Type:" list, select the type of paper that is loaded in the paper tray.
9. If you want to print multiple copies, specify a number of sets in the "Copies:" box.
10. Click [OK].
11. Start printing from the application's [Print] dialog box.

Locked Print

Sending a Locked Print File

1. Click the WordPad menu button in the upper left corner of the window, and then click [Print].
2. In the "Select Printer" list, select the printer you want to use.
3. Click [Preferences].
4. In the "Job Type:" list, click [Locked Print].
5. Click [Details...].
6. Enter a User ID in the "User ID:" box, and then enter a password in the "Password:" box.
7. Click [OK].
8. Change any other print settings if necessary.
9. Click [OK].
10. Start printing from the application's [Print] dialog box.

5

Printing a Locked Print File Using the Control Panel

★ Important

- When printing is completed, the stored file will be deleted.
1. Press the [Home] key on the top left of the control panel, and press the [Printer] icon on the [Home] screen.

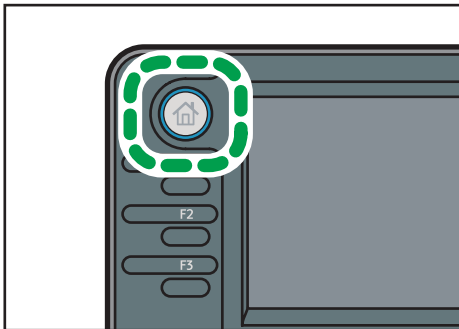

CMR612

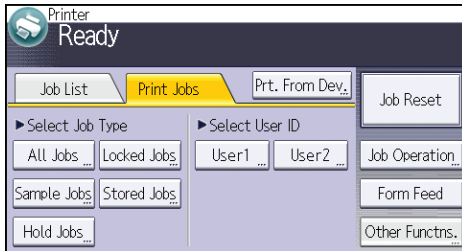
2. Press the [Print Jobs] tab.**3. Press [Locked Jobs].****4. Select the files you want to print.**

You can select all the Locked Print files at once by pressing [All Jobs] after selecting a file.

5. Press [Print].**6. Enter the password using the number keys, and then press [OK].****7. To change the print settings of the document, press [Det.Settings].****8. Enter the number of copies using the number keys if necessary, and then press [Resume Prt.].**

Hold Print

Sending a Hold Print File

1. Click the WordPad menu button in the upper left corner of the window, and then click [Print].
2. In the "Select Printer" list, select the printer you want to use.
3. Click [Preferences].
4. In the "Job Type:" list, click [Hold Print].
5. Click [Details...].
6. Enter a User ID in the "User ID:" box.

You can optionally set a file name of a Hold Print file.

7. To specify the print time of the document, select the [Set Print Time] check box, and then specify the time.

You can specify the time in 24-hour format.

8. Click [OK].
9. Change any other print settings if necessary.
10. Click [OK].
11. Start printing from the application's [Print] dialog box.

5

Printing a Hold Print File Using the Control Panel

★ Important

- When printing is completed, the stored file will be deleted.
1. Press the [Home] key on the top left of the control panel, and press the [Printer] icon on the [Home] screen.

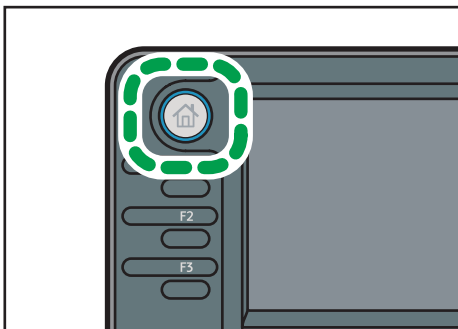

CMR612

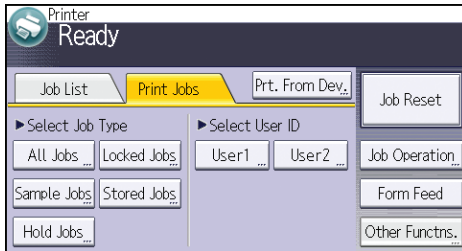
2. Press the [Print Jobs] tab.**3. Press [Hold Jobs].****4. Select the files you want to print.**

You can select all the Hold Print files at once by pressing [All Jobs] after selecting a file.

5. Press [Print].**6. To change the print settings of the document, press [Det.Settings].****7. Enter the number of copies using the number keys if necessary, and then press [Resume Prt.].**

Stored Print

Sending a Stored Print File

1. Click the WordPad menu button in the upper left corner of the window, and then click [Print].
2. In the "Select Printer" list, select the printer you want to use.
3. Click [Preferences].
4. In the "Job Type:" list, select the print method to be used for Stored Print files.

You can select four methods of Stored Print:

To use the Stored Print (Shared) and Store and Print (Shared) functions, authentication must be enabled beforehand. For details, see Security Guide .

5

- **Stored Print**
Stores the file in the machine and prints it later using the control panel.
- **Store and Print**
Prints the file at once and also stores the file in the machine.
- **Stored Print (Shared)**
Stores the file in the machine and allows any user who has print privileges to print the file later using the control panel.
- **Store and Print (Shared)**
Prints the file immediately and also stores the file in the machine. Any user who has print privileges can print any stored file afterward.

5. Click [Details...].
6. Enter a User ID in the "User ID:" box.
You can optionally set a file name and a password of a Stored Print file.
7. Click [OK].
8. Change any other print settings if necessary.
9. Click [OK].
10. Start printing from the application's [Print] dialog box.

Printing a Stored Print File Using the Control Panel

★ Important

- The stored documents are not deleted even after the printing has been completed. For the procedure to delete the documents, see "Deleting Stored Print files", Print .

1. Press the [Home] key on the top left of the control panel, and press the [Printer] icon on the [Home] screen.

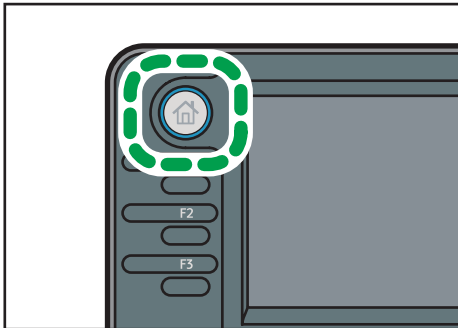

CMR612

2. Press the [Print Jobs] tab.

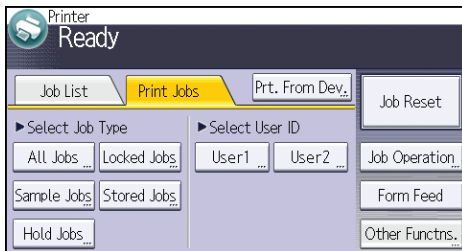

3. Press [Stored Jobs].
4. Select the files you want to print.

You can select all the Stored Print files at once by pressing [All Jobs] after selecting a file.

5. Press [Print].

If you set the password in the printer driver, enter the password.

If multiple print files are selected, and some of these require a password, the machine prints files that correspond to the entered password and files that do not require a password. The number of files to be printed is displayed on the confirmation screen.

6. To change the print settings of the document, press [Det.Settings].
7. Enter the number of copies using the number keys if necessary, and then press [Resume Prt.].

6. Scan

This chapter describes frequently used scanner functions and operations. For the information not included in this chapter, see Scan ② on the supplied CD-ROM.

Basic Procedure When Using Scan to Folder

★ Important

- Before performing this procedure, refer to "Preparation for Sending by Scan to Folder", Scan ② and confirm the details of the destination computer. Also refer to "Registering Folders", Connecting the Machine/ System Settings ②, and register the address of the destination computer to the address book.

1. Press the [Home] key on the top left of the control panel, and press the [Scanner] icon on the [Home] screen.

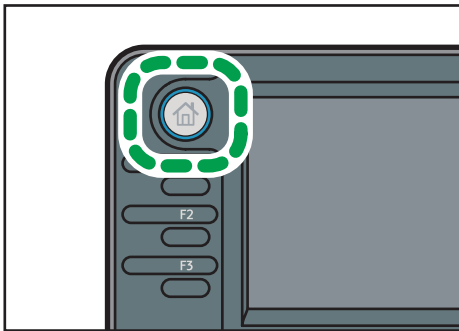

CMR612

2. Make sure that no previous settings remain.
If a previous setting remains, press the [Reset] key.
3. Press the [Folder] tab.

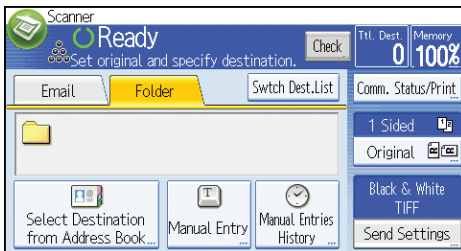

4. Place originals.
5. If necessary, select [Send Settings] or [Original], and specify scan settings according to the original you want to scan.

Example: Scanning the document in color/duplex mode, and saving as a PDF file.

- Press [Original], and then press [2 Sided].
- Press [Send Settings]. Select [Type of Original], and then press [Full Colour].
- Press [Send Settings]. Select [File Type], and then press [PDF].

6. Specify the destination.

You can specify multiple destinations.

7. Press the [Start] key.

Creating a Shared Folder on a Computer Running Windows/Confirming a Computer's Information

The following procedures explain how to create a shared folder on a computer running Windows, and how to confirm the computer's information. In these examples, Windows 7 Ultimate is the operating system, and the computer is a member in a network domain. Write down the confirmed information.

Step 1: Confirming the user name and computer name

6

1. Confirm the user name and the name of the computer you will send scanned documents to.
2. On the [Start] menu, point to [All Programs], then [Accessories], and then click on [Command Prompt].
3. Enter the command "ipconfig/all", and then press the [Enter] key.
4. Confirm the name of the computer.

The computer's name is displayed under [Host Name].

You can also confirm the IPv4 address. The address displayed under [IPv4 Address] is the IPv4 address of the computer.

5. Next, enter the command "set user", and then press the [Enter] key. (Be sure to put a space between "set" and "user".)
6. Confirm the user name.

The user name is displayed under [USERNAME].

Step 2: Creating a shared folder on a computer running Microsoft Windows

Create a shared destination folder in Windows and enable sharing. In the following procedure, a computer which is running under Windows 7 Ultimate and participating in a domain is used as an example.

Important

- You must log in as an Administrators group member to create a shared folder.

- If "Everyone" is left selected in step 6, the created shared folder will be accessible by all users. This is a security risk, so we recommend that you give access rights only to specific users. Use the following procedure to remove "Everyone" and specify user access rights.
1. Create a folder, just as you would create a normal folder, in a location of your choice on the computer.
 2. Right-click the folder, and then click [Properties].
When using Windows XP, right-click the folder, and then click [Sharing and Security].
 3. On the [Sharing] tab, select [Advanced Sharing...].
When using Windows XP, on the [Sharing] tab, select [Share this folder].
Proceed to step 5.
 4. Select the [Share this folder] check box.
 5. Click [Permissions].
 6. In the [Group or user names:] list, select "Everyone", and then click [Remove].
 7. Click [Add...].
 8. In the [Select Users or Groups] window, click [Advanced...].
 9. Specify one or more object types, select a location, and then click [Find Now].
 10. From the list of results, select the groups and users you want to grant access to, and then click [OK].
 11. In the [Select Users or Groups] window, click [OK].
 12. In the [Groups or user names:] list, select a group or user, and then, in the [Allow] column of the permissions list, select either the [Full Control] or [Change] check box.
Configure the access permissions for each group and user.
 13. Click [OK].

Step 3: Specifying access privileges for the created shared folder

If you want to specify access privileges for the created folder to allow other users or groups to access the folder, configure the folder as follows:

1. Right-click the folder created in step 2, and then click [Properties].
2. On the [Security] tab, select [Edit...].
3. Click [Add...].
4. In the [Select Users or Groups] window, click [Advanced...].
5. Specify one or more object types, select a location, and then click [Find Now].
6. From the list of results, select the groups and users you want to grant access to, and then click [OK].

7. In the [Select Users or Groups] window, click [OK].
8. In the [Groups or user names:] list, select a group or user, and then, in the [Allow] column of the permissions list, select either the [Full Control] or [Change] check box.
9. Press [OK] twice.

Registering an SMB Folder

1. Press the [User Tools/Counter] key.
2. Press [Address Book Mangmnt].
3. Press [New Program].
4. Press [Names].
5. Press [Name].

The name entry display appears.

6. Enter the name, and then press [OK].
7. Press [▼] to display [Title 1], [Title 2] and [Title 3].
8. Press [Title 1], [Title 2] or [Title 3] to select the key for the classification you want to use.

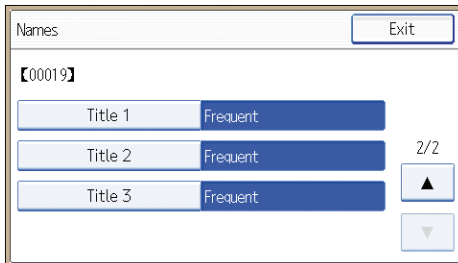

The keys you can select are as follows:

- [Frequent]: Added to the page that is displayed first.
- [AB], [CD], [EF], [GH], [IJK], [LMN], [OPQ], [RST], [UVW], [XYZ], [1] to [10]: Added to the list of items in the selected title.

You can select [Frequent] and one more key for each title.

9. Press [OK].
10. Press [Exit].

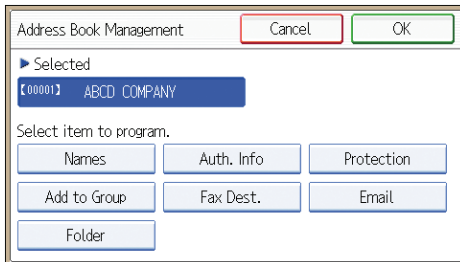
11. Press [Auth. Info].**12. Press [Folder Authentication].****13. Press [Specify Other Auth. Info].**

When [Do not Specify] is selected, the SMB User Name and SMB Password that you have specified in [Default User Name/Password (Send)] of File Transfer settings are applied.

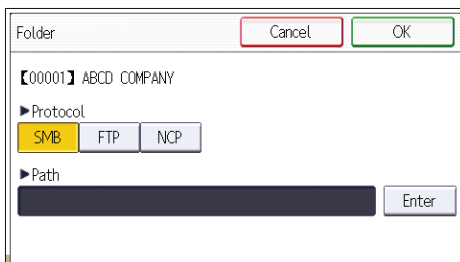
14. Press [Change] under "Login User Name".**15. Enter the login user name of the destination computer, and then press [OK].****16. Press [Change] under "Login Password".****17. Enter the password of the destination computer, and then press [OK].****18. Enter the password again to confirm, and then press [OK].****19. Press [OK].****20. Press [Exit].****21. Press [Folder].****22. Check that [SMB] is selected.****23. Press [Enter] under "Path".****24. Press [Enter] or [Browse Network], and then specify the folder.**

To specify a folder, you can either enter the path manually or locate the folder by browsing the network.

25. Press [Connection Test] to check the path is set correctly.**26. Press [Exit].**

If the connection test fails, check the settings, and then try again.

27. Press [OK] three times.
28. Press the [User Tools/Counter] key.

Locating the SMB folder manually

1. Press [Enter] under "Path".
2. Enter the path where the folder is located.

For example: if the name of the destination computer is "User", and the folder name is "Share", the path will be \\User\Share.

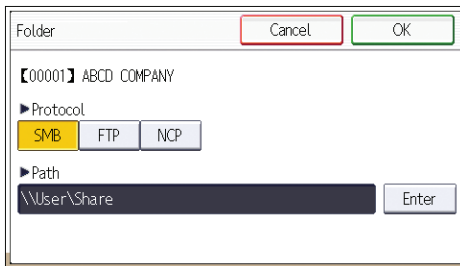

If the network does not allow automatic obtaining of IP addresses, include the destination computer's IP address in the path. For example: if the IP address of the destination computer is "192.168.0.191", and the folder name is "Share", the path will be \\192.168.0.191\Share.

3. Press [OK] four times.

If the format of the entered path is not correct, a message appears. Press [Exit], and then enter the path again.

Locating the SMB folder using Browse Network

1. Press [Browse Network].

The client computers sharing the same network as the machine appear.

Network display only lists client computers you are authorized to access.

2. Select the group that contains the destination computer.
3. Select the computer name of the destination computer.

Shared folders under it appear.

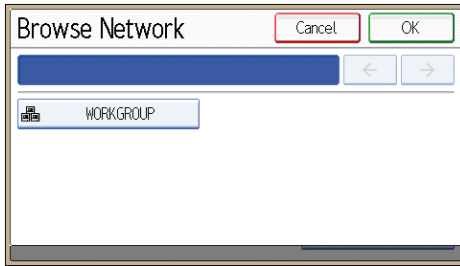

You can press [Up One Level] to switch between levels.

4. Select the folder you want to register.
5. Press [OK] four times.

Deleting an SMB Registered Folder

1. Press the [User Tools/Counter] key.
2. Press [Address Book Mangmnt].
3. Press [Change].
4. Press [Folder].
5. Select the name whose folder you want to delete.

Press the name key, or enter the registered number using the number keys.

You can search by the registered name, user code, fax number, folder name, e-mail address, or IP-Fax destination.

6. Press [Folder].
7. Press the protocol which is not currently selected.
8. Press [OK] twice.
9. Press the [User Tools/Counter] key.

Entering the Path to the Destination Manually

1. Press [Manual Entry].

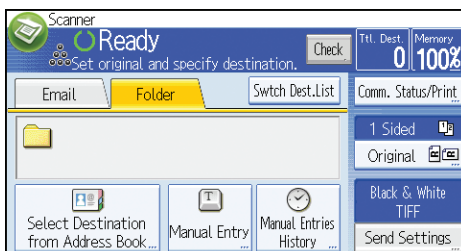

2. Press [SMB].
3. Press [Enter] in [Destination].
4. Press [Enter] on the right side of the path field.
5. Enter the path for the folder.

In the following example path, the shared folder name is "user" and the computer name is "desk01":

```
\\desk01\user
```

6. Press [OK].
7. Depending on the destination setting, enter the user name for logging in to the computer.
Press [Enter] to the right of the user name field to display the soft keyboard.
8. Depending on the destination setting, enter the password for logging in to the computer.
Press [Password] for the password to display the soft keyboard.
9. Press [Connection Test].

A connection test is performed to check whether the specified shared folder exists.

10. Check the connection test result, and then press [Exit].
11. Press [OK].

Basic Procedure for Sending Scan Files by E-mail

1. Press the [Home] key on the top left of the control panel, and press the [Scanner] icon on the [Home] screen.

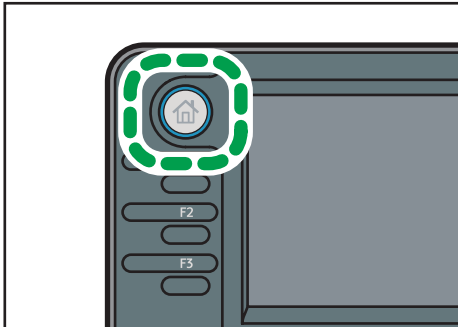

CMR612

2. Make sure that no previous settings remain.
If a previous setting remains, press the [Reset] key.
3. Press the [Email] tab.

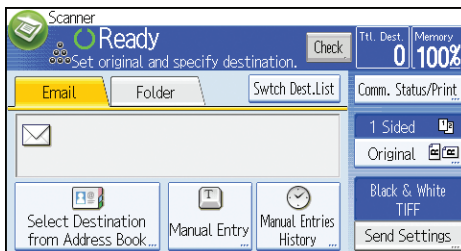

4. Place originals.
5. If necessary, select [Send Settings] or [Original], and specify scan settings according to the original you want to scan.

Example: Scanning the document in color/duplex mode, and saving as a PDF file.

- Press [Original], and then press [2 Sided].
- Press [Send Settings]. Select [Type of Original], and then press [Full Colour].
- Press [Send Settings]. Select [File Type], and then press [PDF].

6. Specify the destination.

You can specify multiple destinations.

7. Press [▼] in [Send Settings] twice, select [Sender Name], and then specify the e-mail sender (originator).

- To use the Message Disposition Notification function, select [Send Settings], press [▼] four times, and then press [Reception Notice].

If you select [Reception Notice], the selected e-mail sender will receive e-mail notification when the e-mail recipient has opened the e-mail.

- Press the [Start] key.

Registering an E-mail Destination

- Press the [User Tools/Counter] key.
- Press [Address Book Mangmnt].
- Press [New Program].
- Press [Names].
- Press [Name].

The name entry display appears.

- Enter the name, and then press [OK].
- Press [▼] to display [Title 1], [Title 2] and [Title 3].
- Press [Title 1], [Title 2] or [Title 3] to select the key for the classification you want to use.

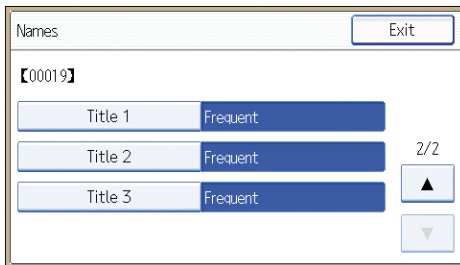

The keys you can select are as follows:

- [Frequent]: Added to the page that is displayed first.
- [AB], [CD], [EF], [GH], [IJK], [LMN], [OPQ], [RST], [UVW], [XYZ], [1] to [10]: Added to the list of items in the selected title.

You can select [Frequent] and one more key for each title.

- Press [OK].
- Press [Exit].
- Press [Email].

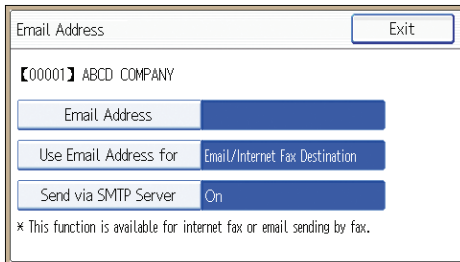
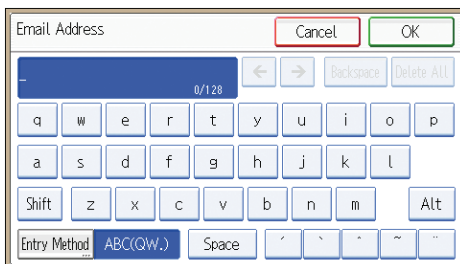
12. Press [Email Address].**13. Enter the e-mail address.****14. Press [OK].****15. Press [Use Email Address for], and then select [Email/Internet Fax Dest.] or [Internet Fax Destination Only].**

If [Email/Internet Fax Dest.] is specified, registered e-mail addresses appear in both the internet fax address display and E-mail address display on the fax function screen, and in the address display on the scanner function screen.

If [Internet Fax Destination Only] is specified, registered e-mail addresses only appear in the internet fax display on the fax function screen.

16. Press [OK].**17. If you want to use Internet fax, press [Send via SMTP Server], and set to [On].****18. Press [OK].****19. Press [Exit].****20. Press [OK].****21. Press the [User Tools/Counter] key.**

Deleting an E-mail Destination

1. Press the [User Tools/Counter] key.
2. Press [Address Book Mangmnt].
3. Press [Change].

4. Press [Email].
5. Select the name whose e-mail address you want to delete.

Press the name key, or enter the registered number using the number keys. You can search by the registered name, user code, fax number, folder name, e-mail address, or IP-Fax destination.

6. Press [Email].
7. Press [Email Address].
8. Press [Delete All], and then press [OK].
9. Press [Exit].
10. Press [OK].
11. Press the [User Tools/Counter] key.

Entering an E-mail Address Manually

1. Press [Manual Entry].

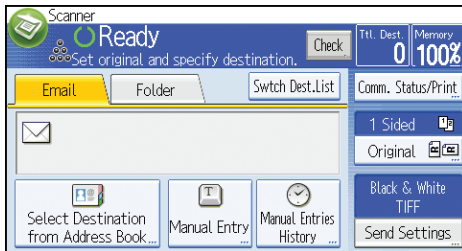

2. Press [Enter] under [Destination].
3. Enter the e-mail address.
4. Press [OK].

Basic Procedure for Storing Scan Files

★ Important

- You can specify a password for each stored file. Files that are not password-protected can be accessed by other users on the same local area network using DeskTopBinder. We recommend that you protect stored files from unauthorized access by specifying passwords.
- Scan file stored in the machine may be lost if some kind of failure occurs. We advise against using the hard disk to store important files. The supplier shall not be responsible for any damage that may result from the loss of files. For long-term storage of files, we recommend the use of DeskTopBinder. For details, contact your local dealer, or see the documentation for DeskTopBinder.

1. Press the [Home] key on the top left of the control panel, and press the [Scanner] icon on the [Home] screen.

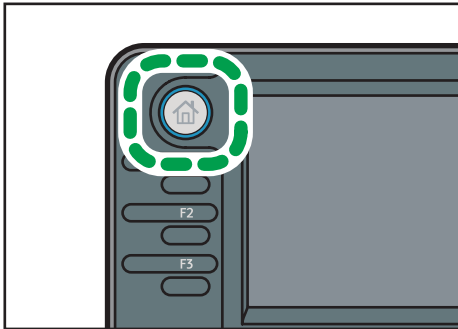

CMR612

2. Make sure that no previous settings remain.
If a previous setting remains, press the [Reset] key.
3. Place originals.
4. Press [Send Settings].

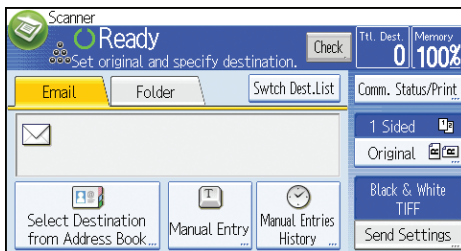

5. Press [▼] four times, and then press [Store File].
6. Press [Store to HDD].
7. If necessary, specify file information, such as [User Name], [File Name], and [Password].
 - User Name

Press [User Name], and then select a user name. To specify an unregistered user name, press [Manual Entry], and then enter the name. After specifying a user name, press [OK].

- File Name

Press [File Name], enter a file name, and then press [OK].

- Password

Press [Password], enter a password, and then press [OK]. Re-enter the password for confirmation, and then press [OK].

8. Press [OK] twice.

9. If necessary, press [Send Settings] or [Original] to configure settings for resolution and scan size.

10. Press the [Start] key.

Checking a Stored File Selected from the List

This section explains how to preview a file selected from the list of stored files.

6

1. Press [Send Settings].

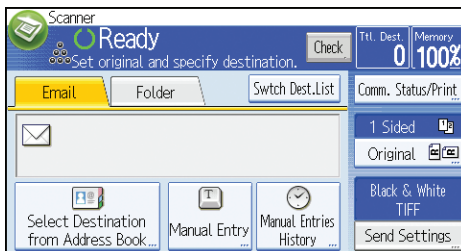

2. Press [▼] four times, and then press [Select/Manage Stored File].

3. From the list of stored files, select the file you want to check.

You can select more than one file.

4. Press [Preview].

Specifying the File Type

This section explains the procedure for specifying the file type of a file you want to send.

File types can be specified when sending files by e-mail or Scan to Folder, sending stored files by e-mail or Scan to Folder, and saving files on a removable memory device.

You can select one of the following file types:

- Single Page: [PDF], [High Compress. PDF], [PDF/A], [TIFF/JPEG]

If you select a single-page file type when scanning multiple originals, one file is created for each single page and the number of files sent is the same as the number of pages scanned.

- Multi-page: [PDF], [High Compress. PDF], [PDF/A], [TIFF]

If you select a multi-page file type when scan multiple originals, scanned pages are combined and sent as a single file.

Selectable file types differ depending on the scan settings and other conditions. For details about file types, see "Notes About and Limitations of File Types", Scan .

1. Press [Send Settings].

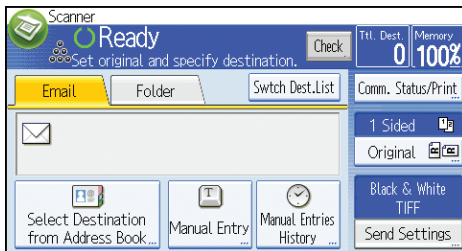

2. Press [File Type].

3. Select a file type.

4. Press [OK] twice.

Specifying Send Settings

1. Press [Send Settings].

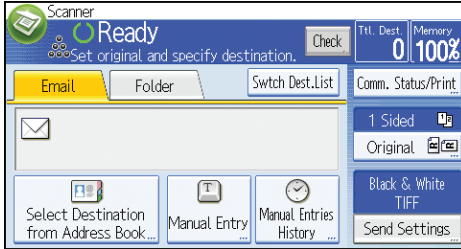

2. Specify resolution, scan size, and other settings, as required.
3. Press [OK].

7. Document Server

This chapter describes frequently used Document Server functions and operations. For the information not included in this chapter, see Copy/ Document Server  on the supplied CD-ROM.

Storing Data

This section describes the procedure for storing documents on the Document Server.

Important

- A document accessed with a correct password remains selected even after operations are complete, and it can be accessed by other users. After the operation, be sure to press the [Reset] key to cancel the document selection.
- The user name registered to a stored document in the Document Server is to identify the document creator and type. It is not to protect confidential documents from others.
- When turning on the fax transmission or scanning by the scanner, make sure that all other operations are ended.

File Name

A file name such as "COPY0001" and "COPY0002" is automatically attached to the scanned document. You can change the file name.

User Name

You can register a user name to identify the user or user group that stored the documents. To assign it, select the user name registered in the Address Book, or enter the name directly. Depending on the security setting, [Access Privileges] may appear instead of [User Name]. For details about the Address Book, see "Registering Addresses and Users for Facsimile/Scanner Functions", Connecting the Machine/ System Settings .

Password

To prevent unauthorized printing, you can specify a password for any stored document. A protected document can only be accessed if its password is entered. If a password is specified for the documents, the key icon appears on the left side of the file name.

1. Press the [Home] key on the top left of the control panel, and press the [Document Server] icon on the [Home] screen.

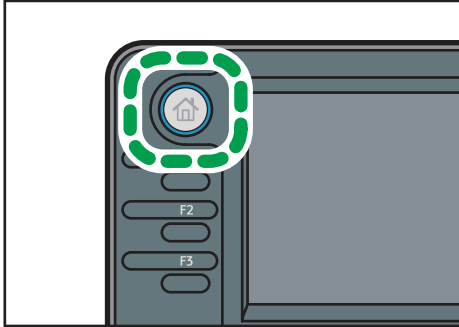

CMR612

2. Press [To Scanning Scrn.].
3. Press [User Name].
4. Specify a user name, and then press [OK].

The user names shown are names that were registered in the Address Book. To specify a name not shown in the screen, press [Manual Entry], and then enter a user name.

5. Press [File Name].
6. Enter a file name, and then press [OK].
7. Press [Password].
8. Enter a password with the number keys, and then press [OK].
You can use four to eight digits for the password.
9. For double-check, enter the password again, and then press [OK].
10. Select the paper tray.
11. Place the original.
12. Specify the original scanning conditions.
13. Press the [Start] key.

The original is scanned. The document is saved in the Document Server.

After scanning, a list of stored documents will be displayed. If the list does not appear, press [Finish Scanning].

Printing Stored Documents

Prints stored documents on the Document Server.

The items you can specify on the printing screen are as follows:

- Paper tray
- The number of prints
- [2 Sided: Top to Top], [2 Sided: Top to Bottom]
- [Sort]
- [Margin Adjustment]

For details about each function, see Copy/ Document Server .

1. Select a document to be printed.

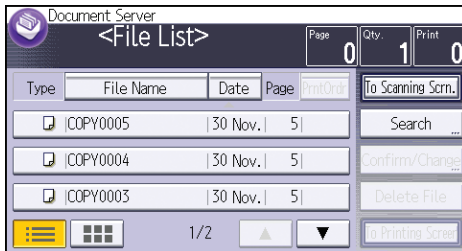

2. When printing two or more documents at a time, repeat step 1.

Up to 30 documents can be printed.

3. When specifying printing conditions, press [To Printing Screen], and then configure print settings.

4. Enter the number of print copies with the number keys.

The maximum quantity that can be entered is 99.

5. Press the [Start] key.

8. Web Image Monitor

This chapter describes frequently used Web Image Monitor functions and operations. For the information not included in this chapter, see Connecting the Machine/ System Settings on the supplied CD-ROM or Web Image Monitor Help.

Displaying Top Page

This section explains the Top Page and how to display Web Image Monitor.

★ Important

- When entering an IPv4 address, do not begin segments with zeros. For example: If the address is "192.168.001.010", you must enter it as "192.168.1.10".

1. Start your Web browser.
2. Enter "http://(machine's IP address or host name)/" in your Web browser's URL bar.

Top Page of Web Image Monitor appears.

If the machine's host name has been registered on the DNS or WINS server, you can enter it.

When setting SSL, a protocol for encrypted communication, under environment which server authentication is issued, enter "https://(machine's IP address or host name)/".

Web Image Monitor is divided into the following areas:

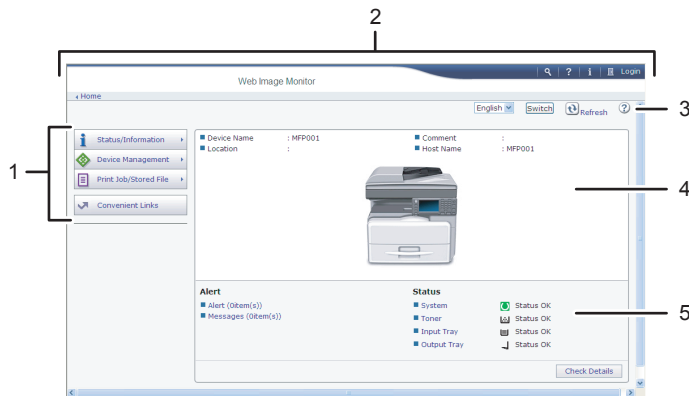

CMM004

1. Menu area



If you select a menu item, its content will be shown.

2. Header area

The dialog box for switching to the user mode and administrator mode appears, and each mode's menu will be displayed.

The link to Help and dialog box for keyword search appears.

3. Refresh/Help

 (Refresh): Click  at the upper right in the work area to update the machine information. Click the Web browser's [Refresh] button to refresh the entire browser screen.

 (Help): Use Help to view or download Help file contents.

4. Basic Information area

Displays the basic information of the machine.

5. Work area

Displays the contents of the item selected in the menu area.

Viewing Received Fax Documents Using Web Image Monitor

1. Start Web Image Monitor.
2. Click [Fax Received File] on the [Print Job/Stored File] menu in the left pane.
3. If you have programmed a user code for the stored reception file, enter the code, and then press [OK].

If the programmed user code was deleted from the Address Book, a message indicating incorrect user code entry appears. If this is the case, reprogram a user code.

4. Click the property icon  of the desired fax document.
5. View the content of the fax document.
6. To download the received fax document, select [PDF], [PDF/A], or [Multi-page: TIFF], and then click [Download].

When you select [PDF], make the necessary "PDF File Security Settings" before clicking [Download]. Adobe Acrobat Reader/Adobe Reader starts and the selected document is displayed.

7. Quit Web Image Monitor.

9. Adding Paper and Toner

This chapter describes how to load paper into the paper tray and recommended paper sizes and types.

Loading Paper into Paper Trays

★ Important

- If a paper tray is pushed vigorously when putting it back into place, the position of the tray's side fences may slip out of place.
- Check the paper edges are aligned at the right side.
- When loading a low number of sheets, be sure not to squeeze the side fences in too tightly. If the side fences are squeezed too tightly against the paper, the edges may crease or the paper may be misfed.

↓ Note

- Various sizes of paper can be loaded in the paper trays by adjusting the positions of side fences and end fence. For details, see "Changing the Paper Size in the Paper Trays", Paper Specifications and Adding Paper 📄.

Loading Paper into Tray 1

1. Carefully pull out the paper tray until it stops.

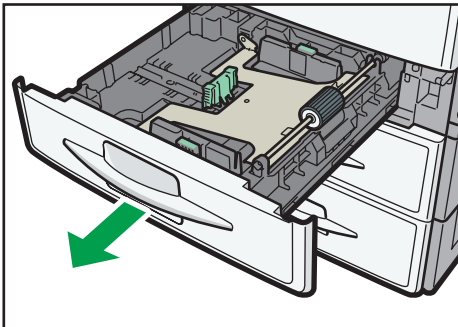

CMS019

2. Press the metal plate down until it clicks.

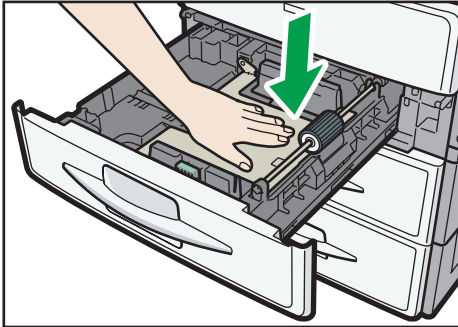

CMS020

3. Square the paper and load it print side up.

Do not stack paper over the limit mark.

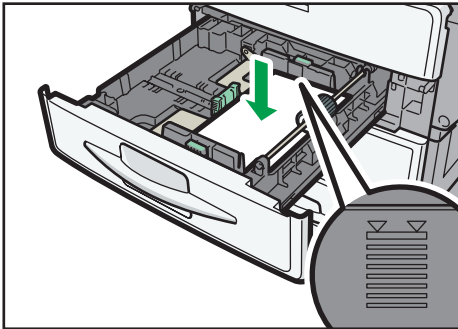

CMS021

4. Carefully slide the paper tray fully in.

9

Loading Paper into Trays 2 and 3

Each paper tray is loaded in the same way.

In the following example procedure, paper is loaded into tray 2.

1. Carefully pull out the paper tray until it stops.

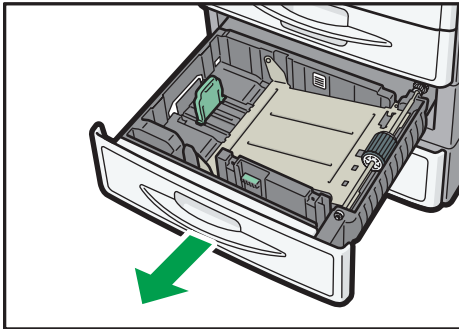

CMS041

2. While pressing down the release lever of the side fence, slide the side fence outward.

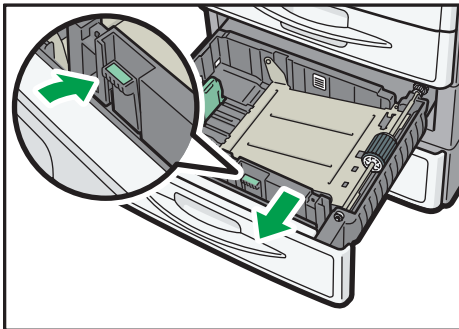

CMS033

If the paper size that is loaded is $8\frac{1}{4} \times 14$ or $8\frac{1}{2} \times 14$, proceed to step 4.

3. While pinching the release levers of the end fence, slide the end fence outward.

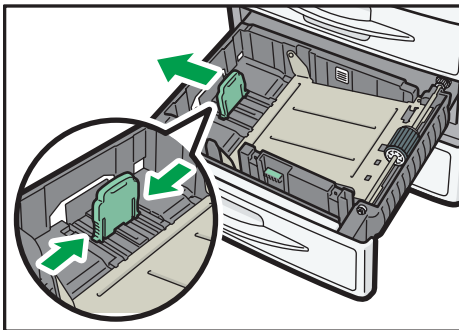

CMS034

4. Press the metal plate down until it clicks.

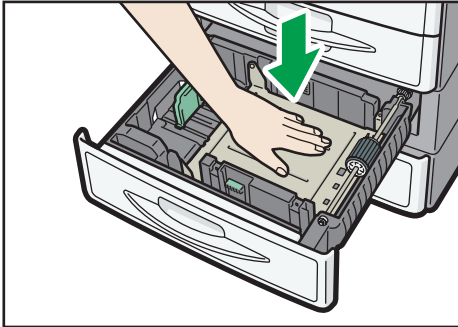

CMS036

5. Square the paper and load it print side up.

Do not stack paper over the limit mark.

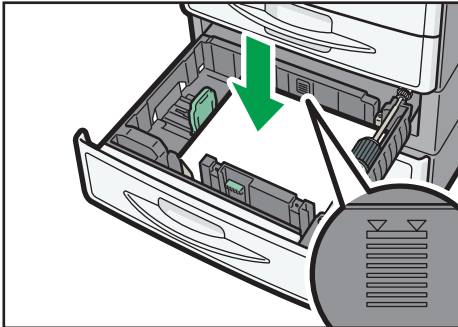

CMS037

6. Align the back and side fences gently against the paper you loaded.

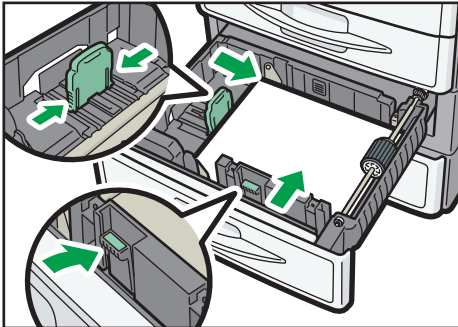

CMS038

7. Carefully slide the paper tray fully in.

Loading Paper into the Bypass Tray

Use the bypass tray to use OHP transparencies, adhesive labels, translucent paper, and paper that cannot be loaded in the paper trays.

★ Important

- The maximum number of sheets you can load at the same time depends on paper type. Do not load paper over the limit mark. For the maximum number of sheets you can load, see p.135 "Recommended Paper Sizes and Types".

1. Open the bypass tray.

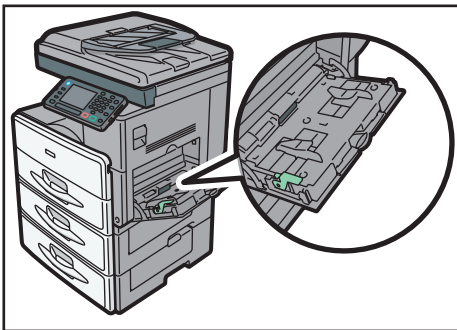

CMS022

2. Push up the release lever.

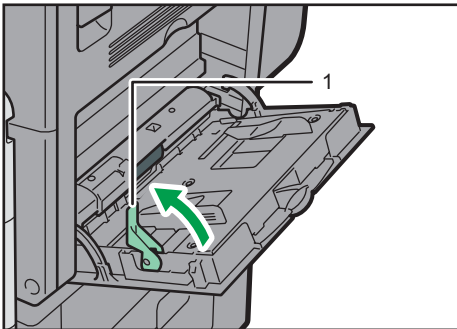

CMS023

1. Release lever

3. Insert the paper face down.

4. Align the paper guides to the paper size.

If the guides are not flush against the paper, images might be skewed or paper misfeeds might occur.

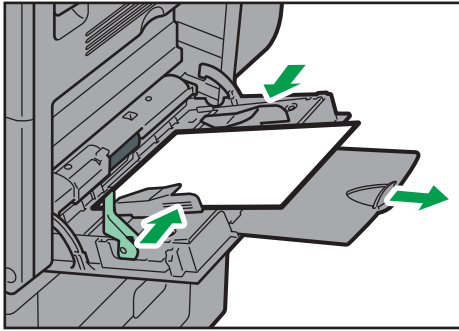

CMS024

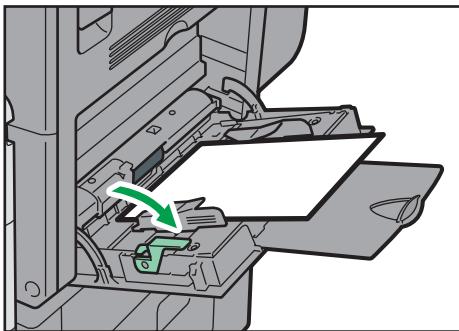

5. Push down the release lever.

A beeping sound will occur after the paper is inserted and the release lever is pushed down.



CMS025

Note



- When you use the bypass tray, it is recommended to load the paper in  orientation.
- When copying from the bypass tray, see "Copying from the Bypass Tray", Copy/ Document Server . When printing from a computer, see p. 129 "Settings to Use the Bypass Tray under the Printer Function".
- Certain types of paper might not be detected properly when placed on the bypass tray. If this happens, remove the paper and place it on the bypass tray again.
- Pull the extender out when loading paper in the bypass tray.
- When the [Panel Key Sound] is turned off, it will not sound if you load paper into the bypass tray. For details about [Panel Key Sound], see "System Settings", Connecting the Machine/ System Settings .
- When loading thick paper or OHP transparencies, specify the paper size and the paper type.
- Letterhead paper must be loaded in a specific orientation. For details, see, p.132 "Loading Orientation-Fixed Paper or Two-Sided Paper".
- You can load envelopes into the bypass tray. Envelopes must be loaded in a specific orientation. For details, see p. 139 "Envelopes".

Settings to Use the Bypass Tray under the Printer Function

★ Important

- If you select [Machine Setting(s)] in [Bypass Tray] under [Tray Setting Priority] in [System] of the Printer Features menu, the settings made using the control panel have priority over the printer driver settings. For details, see "System", Print .
- The default setting of [Bypass Tray] is [Driver/Command].

↓ Note

- Settings remain valid until they are changed. After printing, be sure to clear settings for the next user.
- For details about setting printer drivers, see "Printing Documents", Print .
-  **Region A** (mainly Europe and Asia)
 - [A4] is the default setting for [Printer Bypass Paper Size].
-  **Region B** (mainly North America)
 - [8 1/2 × 11] is the default setting for [Printer Bypass Paper Size].

Setting the paper size using the control panel

1. Press the [User Tools/Counter] key.

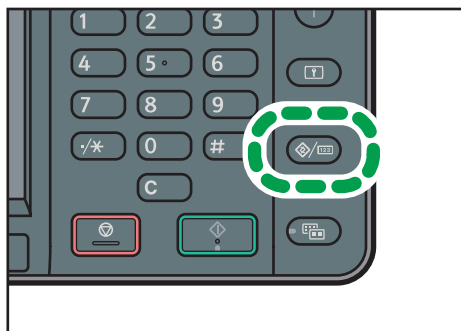

CMR633

2. Press [Tray Paper Settings].
3. Press [▼].
4. Press [Printer Bypass Paper Size].
5. Select the paper size.
6. Press [OK].
7. Press the [User Tools/Counter] key.

Note

- When loading thick paper or OHP transparencies, specify the paper size and the paper type.

Setting custom size paper using the control panel

1. Press the [User Tools/Counter] key.

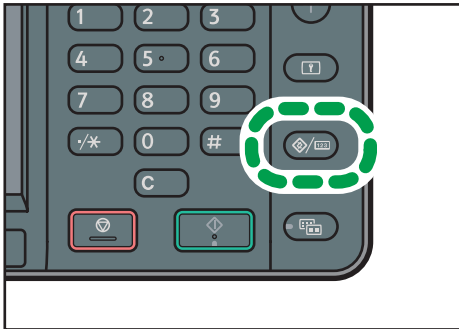

CMR633

2. Press [Tray Paper Settings].
3. Press [▼].
4. Press [Printer Bypass Paper Size].
5. Press [Custom Size].
If a custom size is already specified, press [Change].
6. Press [Vertical].
7. Enter the size of the paper using the number keys, and then press the [#] key.
8. Press [Horizontal].
9. Enter the size of the paper using the number keys, and then press the [#] key.
10. Press [OK] twice.
11. Press the [User Tools/Counter] key.

Note

- When loading thick paper, specify the paper size and the paper type.

Setting thick paper or OHP transparencies using the control panel

Important

- Use A4 or 8 1/2 × 11 size OHP transparencies, and specify their size.
- When you load OHP transparencies, check the front and back of the sheets, and place them correctly.

- When printing onto OHP transparencies, remove printed sheets one by one.

1. Press the [User Tools/Counter] key.

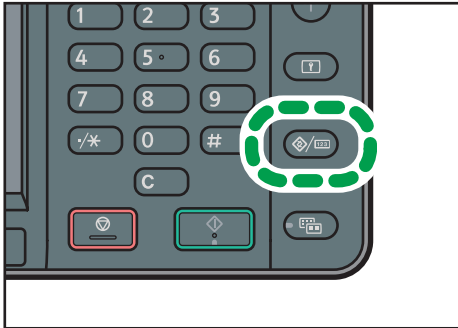

CMR633

2. Press [Tray Paper Settings].
3. Press [▼].
4. Press [Printer Bypass Paper Size], and then specify the paper size.
5. Press [OK].
6. Press [Paper Type: Bypass Tray].
7. Press [Paper Type].
8. Select the paper type, and then press [OK].

To load thick paper, make sure that [Plain Paper] is selected.

Press [OHP (Transparency)] when loading OHP transparencies.

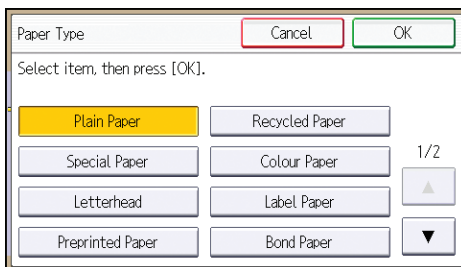

9. When printing onto thick paper, press [Paper Thickness]. When printing onto OHP transparencies, proceed to step 11.
10. Press [Thick Paper], and then press [OK].
11. Press the [User Tools/Counter] key.

↓ **Note**

- We recommend that you use specified OHP transparencies.
- For details about paper thickness, see "System Settings", Connecting the Machine/ System Settings





Loading Orientation-Fixed Paper or Two-Sided Paper

Orientation-fixed (top to bottom) or two-sided paper (for example, letterhead paper, punched paper, or copied paper) might not print correctly, depending on how the originals and paper are placed.





Settings for the User Tools

- Copier mode
Specify [On] for [Letterhead Setting] in [Input/Output] under the Copier/Docu. Server Features menu, and then place the original and paper as shown below.
- Printer mode
Specify [Auto Detect] or [On (Always)] for [Letterhead Setting] in [System] under the Printer Features menu, and then place the paper as shown below.



For details about the letterhead settings, see "Copier/Document Server Features", Copy/Document Server , or "Printer Features", Print .



Original orientation and paper orientation

The meanings of the icons are as follows:







Icon	Meaning
 	Place or load paper scanned or printed side face up.
 	Place or load paper scanned or printed side face down.

- Original orientation





Original orientation	Exposure glass	ADF
Portrait <input checked="" type="checkbox"/>		

Original orientation	Exposure glass	ADF
Landscape (☑)	<ul style="list-style-type: none"> Copy  Scanner  	

- Paper orientation
 - Copier mode

Copy side	Tray 1	Trays 2 and 3	Bypass tray
One-sided	 		 
Two-sided			Unavailable

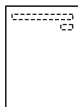
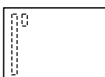
- Printer mode

Print side	Tray 1	Trays 2 and 3	Bypass tray
One-sided	 		 
Two-sided			Unavailable

Note

- In printer mode:
 - To print on letterhead paper when [Auto Detect] is specified for [Letterhead Setting], you must specify [Letterhead] as the paper type in the printer driver's settings.

- If a print job is changed partway through printing from one-sided to two-sided printing, one-sided output after the first copy may be printed facing a different direction. To ensure all paper is output facing the same direction, specify different input trays for one-sided and two-sided printing. Note also that two-sided printing must be disabled for the tray specified for one-sided printing.
- For details about how to make two-sided prints, see "Printing on Both Sides of Sheets", Print .
- In copier mode:
 - For details about how to make two-sided copies, see p.59 "Duplex Copying".

Recommended Paper Sizes and Types

This section describes recommended paper sizes and types.

★ Important

- If you use damp or curled paper, a paper jam may occur.
- Do not use paper designed for inkjet printers, as these may stick to the fusing unit and cause a misfeed.
- When you load OHP transparencies, check the front and back of the sheets, and place them correctly, or a misfeed might occur.
- For details about and recommendations concerning thick paper, see p. 138 "Thick Paper".
- For details about various details about and recommendations concerning envelopes, see p. 139 "Envelopes".



Tray 1

Paper type and weight	Paper size	Paper capacity
60–90 g/m ² (16–24 lb. Bond) Plain Paper 1–Plain Paper 2	Select the paper size using the System Settings menu: A4☐, A5☐, B5 JIS☐, 8 ¹ / ₂ × 11☐, 5 ¹ / ₂ × 8 ¹ / ₂ ☐, 16K☐	250 sheets

Trays 2 and 3

Paper type and weight	Paper size	Paper capacity
60–90 g/m ² (16–24 lb. Bond) Plain Paper 1–Plain Paper 2	Select the paper size using the System Settings menu: A4☐, 8 ¹ / ₂ × 14☐, 8 ¹ / ₂ × 13☐, 8 ¹ / ₂ × 11☐, 8 ¹ / ₄ × 14☐, 8 ¹ / ₄ × 13☐	500 sheets

Bypass tray

Paper type and weight	Paper size	Paper capacity
60–157 g/m ² (16–40 lb. Bond) Plain Paper 1–Thick Paper	Select the paper size ^{*1} : A4, A5, A6, B5 JIS, B6 JIS, 8 1/2 × 14, 8 1/2 × 13, 8 1/2 × 11, 8 1/4 × 14, 8 1/4 × 13, 8 × 13, 7 1/4 × 10 1/2, 5 1/2 × 8 1/2, 16K	<ul style="list-style-type: none"> Plain Paper 1–Plain Paper 2: 100 sheets Middle Thick–Thick Paper: ^{*3}
60–157 g/m ² (16–40 lb. Bond) Plain Paper 1–Thick Paper	Custom size ^{*2} :  Region A Vertical: 90.0–216.0 mm Horizontal: 139.0–600.0 mm  Region B Vertical: 3.55–8.50 inches Horizontal: 5.48–23.62 inches	<ul style="list-style-type: none"> Plain Paper 1–Plain Paper 2: 100 sheets Middle Thick–Thick Paper: ^{*3}
Translucent paper	A4	10 sheets
OHP transparencies	A4, 8 1/2 × 11	10 sheets
Label paper (adhesive labels)	A4, 8 1/2 × 11	1 sheet
Envelopes	Select the paper size ^{*1} : 4 1/8 × 9 1/2, 3 7/8 × 7 1/2, C5 Env, C6 Env, DL Env	^{*3}

^{*1} For copier mode, see "Copying onto Regular Size Paper from the Bypass Tray", Copy/ Document Server. For printer mode, see p. 129 "Setting the paper size using the control panel".

^{*2} Enter the paper size. For copier mode, see "Copying onto Custom Size Paper from the Bypass Tray", Copy/ Document Server. For printer mode, see p. 130 "Setting custom size paper using the control panel".

^{*3} Do not stack over the limit mark. The number of sheets you can load in the paper tray varies depending on the weight and condition of the paper.



Paper Thickness

Paper Thickness ^{*1}	Paper weight
Plain Paper 1	60–80 g/m ² (16–20 lb. Bond)

Paper Thickness ^{*1}	Paper weight
Plain Paper 2	81–90 g/m ² (20–24 lb. Bond)
Middle Thick	91–105 g/m ² (24–28 lb. Bond)
Thick Paper	106–157 g/m ² (28–40 lb. Bond)

*1 Print quality will decrease if the paper you are using is close to the minimum or maximum weight. Change the paper weight setting to thinner or thicker.

↓ Note

- Certain types of paper produce noise when delivered. This noise does not indicate a problem and print quality is unaffected. (Translucent paper and OHP transparencies can produce noise when delivered.)
- The paper capacity described in the tables above is an example. Actual paper capacity might be lower, depending on the paper type.
- When loading paper, make sure the stack height does not exceed the limit mark of the paper tray.
- If multiple sheet feeding occurs, fan sheets thoroughly or load sheets one by one from the bypass tray.
- Flatten out curled sheets before loading them.
- When loading envelopes, see p.139 "Envelopes".
- When loading thick paper of 106–157 g/m² (28–40 lb. Bond), see p.138 "Thick Paper".
- When copying or printing onto letterhead paper, the paper placing orientation is different depending on which function you are using. For details, see p.132 "Loading Orientation-Fixed Paper or Two-Sided Paper".
- If you load paper of the same size and same type in two or more trays, the machine automatically shifts to the other tray when the first tray in use runs out of paper. This function is called Auto Tray Switching. (However, if the paper type of one tray is recycled or special paper, the settings of the other trays must be the same for the Auto Tray Switching function to work.) This saves interrupting a copy run to replenish paper when making a large number of copies. You can specify the paper type of the paper trays under [Paper Type: Tray 1]–[Paper Type: Tray 3]. For details, see "System Settings", Connecting the Machine/ System Settings . For the setting procedure of the Auto Tray Switching function, see "Copier/Document Server Features", Copy/ Document Server .
- When loading label paper:
 - We recommend that you use specified label paper.
 - Place one sheet at a time.
 - After pressing [, press [Paper Type], and then press [Thick Paper].
- When loading OHP transparencies:

- When copying onto OHP transparencies, see "Copying onto OHP Transparencies", Copy/Document Server .
- When printing on OHP transparencies from the computer, see p.130 "Setting thick paper or OHP transparencies using the control panel".
- Fan OHP transparencies thoroughly whenever you use them. This prevents OHP transparencies from sticking together, and from feeding incorrectly.
- Remove copied or printed sheets one by one.
- When loading translucent paper:
 - Remove copied or printed sheets one by one.
 - When loading translucent paper, always use long grain paper, and set the paper direction according to the grain.
 - Translucent paper easily absorbs humidity and becomes curled. Remove curl in the translucent paper before loading.

Thick Paper

This section gives you various details about and recommendations concerning thick paper.

When loading thick paper of 106–157 g/m² (28–40 lb. Bond) in the bypass tray, follow the recommendations below to prevent misfeeds and loss of image quality.

- Store all your paper in the same environment - a room where the temperature is 20–25 °C (68–77 °F) and the humidity is 30–65%.
- When loading thick paper, set the paper direction according to its grain, as shown in the following diagram:

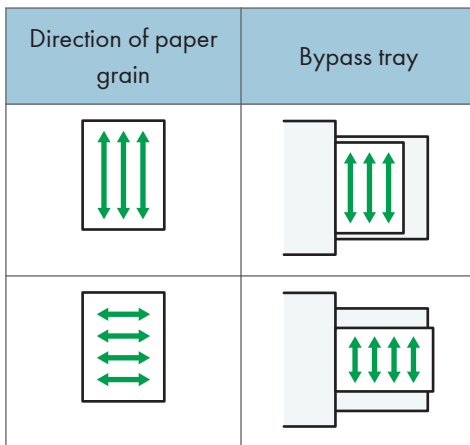

 **Note**

- Select [Thick Paper] for [Paper Type] of the bypass tray.

- Even if thick paper is loaded as described above, normal operations and print quality might still not be possible, depending on the paper type.
- Prints might have prominent vertical creases.
- Prints might be noticeably curled. Flatten out prints if they are creased or curled.

Envelopes

This section gives you various details about and recommendations concerning envelopes.

★ Important

- Do not use window envelopes.
- Fan the envelopes before loading them to separate them and prevent the glue on them from causing them to stick together. If fanning does not prevent them sticking together, load them one by one. Note that some types of envelopes cannot be used with this machine.
- Misfeeds might occur depending on the length and shape of the flaps.
- Before loading envelopes, press down on them to remove any air from inside, flatten out all four edges. If they are bent or curled, flatten their leading edges (the edge going into the machine) by running a pencil or ruler across them.

In copier mode

When copying onto envelopes, load them according to the applicable orientation shown below. Load the envelopes in the same direction as the original.

How to load envelopes

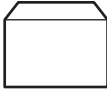
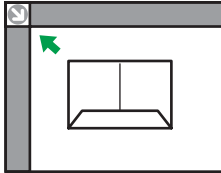
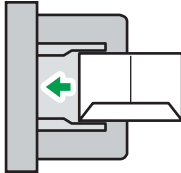
Orientation of envelopes	Exposure glass	Bypass tray
Side-opening envelopes  	 <ul style="list-style-type: none"> • Flaps: closed • Bottom side of envelopes: toward the back of the machine • Side to be scanned: face down 	 <ul style="list-style-type: none"> • Flaps: closed • Bottom side of envelopes: toward the back of the machine • Side to be printed: face down

When loading envelopes, specify the envelope type and thickness. For details, see p.68 "Copying onto Envelopes".

In printer mode

When printing onto envelopes, load them according to the applicable orientation shown below:

How to load envelopes

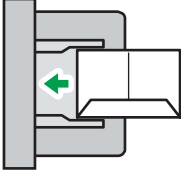
Types of envelopes	Bypass tray
<p>Side-opening envelopes</p> 	 <ul style="list-style-type: none"> • Flaps: closed • Bottom side of envelopes: toward the back of the machine • Side to be printed: face down

When loading envelopes, select "Thick Paper" as the paper thickness and "Plain Paper" as the paper type using both the User Tools and printer driver. For details, see "Printing on Envelopes", Print .

To print on envelopes that are loaded with their bottom edge pointing toward the back of the machine, rotate the print image by 180 degrees using the printer driver.

Recommended envelopes

For information about recommended envelopes, contact your local dealer.

For details about the sizes of envelopes you can load, see p.135 "Recommended Paper Sizes and Types".

Note

- Load only one size and type of envelope at a time.
- To get better output quality, it is recommended that you set the right, left, top, and bottom print margin, to at least 10 mm (0.4 inches) each.
- Output quality on envelopes may be uneven if parts of an envelope have differing thicknesses. Print one or two envelopes to check print quality.
- Flatten out prints if they are creased or curled.
- Check the envelopes are not damp.
- High temperature and high humidity conditions can reduce print quality and cause envelopes to become creased.

- Depending on the environment, copying or printing on envelopes may wrinkle them even if they are recommended.
- Certain types of envelopes might come out creased, dirtied, or misprinted. If you are printing a solid color on an envelope, lines may appear where the overlapped edges of the envelope make it thicker.

Adding Toner

This section explains precautions when adding toner, how to send faxes or scanned documents when the toner has run out, and how to dispose of used toner.

WARNING

- Do not incinerate toner (new or used) or toner containers. Doing so risks burns. Toner will ignite on contact with naked flame.

WARNING

- Do not store toner (new or used) or toner containers anywhere near naked flames. Doing so risks fire and burns. Toner will ignite on contact with naked flame.

WARNING

- Do not use the cleaner to suck spilled toner (including used toner). Sucked toner may cause firing or explosion due to electrical contact flickering inside the cleaner. However, it is possible to use the cleaner designed for dust explosion-proof purpose. If toner is spilled over the floor, sweep up spilled toner slowly and clean remainder with wet cloth.

CAUTION

- Do not crush or squeeze toner containers. Doing so can cause toner spillage, possibly resulting in dirtying of skin, clothing, and floor, and accidental ingestion.

CAUTION

- Store toner (new or used), toner containers, and components that have been in contact with toner out of reach of children.

CAUTION

- If toner or used toner is inhaled, gargle with plenty of water and move into a fresh air environment. Consult a doctor if necessary.

CAUTION

- If toner or used toner gets into your eyes, flush immediately with large amounts of water. Consult a doctor if necessary.

CAUTION

- If toner or used toner is swallowed, dilute by drinking a large amount of water. Consult a doctor if necessary.

⚠ CAUTION

- When removing jammed paper or replacing toner, avoid getting toner (new or used) on your clothing. If toner comes into contact with your clothing, wash the stained area with cold water. Hot water will set the toner into the fabric and make removing the stain impossible.

⚠ CAUTION

- When removing jammed paper or replacing toner, avoid getting toner (new or used) on your skin. If toner comes into contact with your skin, wash the affected area thoroughly with soap and water.

★ Important

- Always replace the toner cartridge when a notification appears on the machine.
- Fault may occur if you use toner other than the recommended type.
- When adding toner, do not turn off the main power. If you do, settings will be lost.
- Store toner where it will not be exposed to direct sunlight, temperatures above 35 °C (95 °F), or high humidity.
- Store toner on a flat surface.
- Do not shake the toner cartridge with its mouth down after removing it. Residual toner may scatter.
- Do not repeatedly install and remove toner cartridges. This will result in toner leakage.

Follow the instruction on the screen regarding how to replace a toner cartridge.

↓ Note

- If "🖨️ Toner Cartridge is almost empty." appears, the toner has almost run out. Have a replacement toner cartridge at hand.
- If 🖨️ appears when there is still toner in the cartridge, hold the cartridge with the opening upward, shake it well, and then reinstall it.
- You can make about 50 copies even after 🖨️ appears, but replace the toner early to prevent poor copy quality.
- You can check the name of the required toner and the replacement procedure using the [🖨️ Add Toner] screen.
- For details about how to check contact number where you can order supplies, see "Enquiry", Maintenance and Specifications 📞.

Sending Faxes or Scanned Documents When Toner Has Run Out

When the machine has run out of toner, the indicator on the display lights. Note that even if there is no toner left, you can still send faxes or scanned documents.

 **Important**

- If number of communications executed after the toner has run out and not listed in the automatically output Journal exceeds 200, communication is not possible.

1. Make sure the machine is in facsimile or scanner mode.
2. Perform transmission operation.

The error message disappears.

 **Note**

- Any reports are not printed.

Disposing of Used Toner

This section describes what to do with used toner.

Toner cannot be re-used.

Pack used toner containers in the container's box or a bag to prevent the toner from leaking out of the container when you dispose of it.

 **Region A** (mainly Europe and Asia)

If you want to discard your used toner container, please contact your local sales office. If you discard it by yourself, treat it as general plastic waste material.

 **Region B** (mainly North America)











Please see our local company website for information on the recycling of supply products, or you can recycle items according to the requirements of your local municipalities or private recyclers.

10. Troubleshooting

This chapter describes basic troubleshooting procedures.

Indicators

This section describes the indicators displayed when the machine requires the user to remove misfed paper, to add paper, or to perform other procedures.

Indicator	Status
 : Paper Misfeed indicator	Appears when a paper misfeed occurs. For details about removing jammed paper, see "Removing Jammed Paper", Troubleshooting  .
 : Original Misfeed indicator	Appears when an original misfeed occurs. For details about removing jammed paper, see "Removing Jammed Paper", Troubleshooting  .
 : Load Paper indicator	Appears when paper runs out. For details about loading paper, see "Loading Paper", Paper Specifications and Adding Paper  .
 : Add Toner indicator	Appears when toner runs out. For details about adding toner, see "Adding Toner", Maintenance and Specifications  .
 : Waste Toner Full indicator	Appears when the waste toner bottle is full. Contact your sales or service representative.
 : Service Call indicator	Appears when the machine is malfunctioning or requires maintenance.
 : Open Cover indicator	Appears when one or more covers of the machine are open.

When an Indicator for the [Check Status] Key Is Lit

If an indicator for the [Check Status] key lights up, press the [Check Status] key to display the [Check Status] screen. Check the status of each function in the [Check Status] screen.

[Check Status] screen

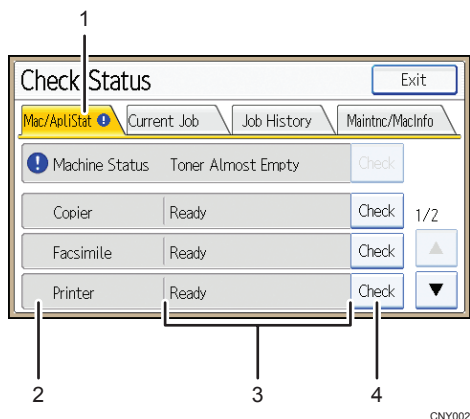

CNY002

1. [Mac/ApliStat] tab

Indicates the status of the machine and each function.

2. Status icons

Each icon that can be displayed is described below:

: The function is performing a job.

: An error has occurred on the machine.

: An error has occurred in the function being used. Or, the function cannot be used because an error has occurred on the machine.

3. Messages

Displays a message that indicates the status of the machine and each function.



4. [Check]

If an error occurs in the machine or a function, press [Check] to view details.

Pressing [Check] displays an error message or the corresponding function screen. Check the error message displayed on the function screen and take the appropriate action.

- p. 154 "Messages Displayed When Using the Copy/Document Server Function"
- p. 156 "Messages Displayed When Using the Facsimile Function"
- p. 169 "Messages Displayed When Using the Printer Function"
- p. 182 "Messages Displayed When Using the Scanner Function"

The following table explains problems that cause the indicator to light:

Problem	Causes	Solutions
Documents and reports do not print out.	The paper output tray is full.	Remove the prints from the tray.
Documents and reports do not print out.	There is no paper left.	Load paper. For details about loading paper, see "Loading Paper", Paper Specifications and Adding Paper  .
An error has occurred.	A function which has the status "Error Occurred" in the [Check Status] screen is defective.	Press [Check] in the function which the error has occurred. Then check the displayed message, and take appropriate action. For details about error messages and their solutions, see p.154 "When Messages Are Displayed on the Control Panel". You can use other functions normally.
The machine is unable to connect to the network.	A network error has occurred.	<ul style="list-style-type: none"> • Press [Check] in the function which error is occurred. And then check the displayed message, and take appropriate action. For details about error messages and their solutions, see p.154 "When Messages Are Displayed on the Control Panel". • Check that the machine is correctly connected to the network, and that the machine is correctly set. For details about how to connect the network, see "Interface Settings", Connecting the Machine/ System Settings . • For details about connecting to the network, contact your administrator. • If the indicator is still lit even after trying to solve the problem as described here, contact your service representative.

Panel Tone

The following table describes the meaning of the various beep patterns that the machine produces to alert users about left originals and other machine conditions.

Beep pattern	Meaning	Causes
Single short beep	Panel/screen input accepted.	A control panel or screen key was pressed.
Short, then long beep	Panel/screen input rejected.	An invalid key was pressed on the control panel or screen, or the entered password was incorrect.
Single long beep	Job completed successfully.	A Copy/Document Server Features job has finished.
Two long beeps	Machine has warmed up.	When the power is turned on or the machine exits Sleep mode, the machine has fully warmed up and is ready for use.
Five long beeps	Soft alert	An auto reset was performed through the Simple Screen of the Copy/Document Server function, the Facsimile function, or the Scanner function.
Five long beeps repeated four times.	Soft alert	An original has been left on the exposure glass or paper tray is empty.
Five short beeps repeated five times.	Strong alert	The machine requires user attention because paper has jammed, the toner needs replenishing, or other problems have occurred.





↓ Note





- Users cannot mute the machine's beep alerts. When the machine beeps to alert users of a paper jam or toner request, if the machine's covers are opened and closed repeatedly within a short space of time, the beep alert might continue, even after normal status has resumed.
- You can select to enable or disable beep alerts. For details about Panel Key Sound, see "General Features", Connecting the Machine/ System Settings .

When You Have Problems Operating the Machine



This section describes common problems and messages. If other messages appear, follow the instructions displayed.

Problem	Causes	Solutions
The [Facsimile] or [Scanner] icon does not appear on the [Home] screen even though the copier screen appears when the machine is turned on using the main power switch.	Functions other than the copier function are not yet ready.	Functions appear on the [Home] screen when they become ready for use. Time required varies by function. Wait a little longer.
The machine has just been turned on and the User Tools screen is displayed, but the User Tools menu has items missing.	Functions other than the copier function are not yet ready.	Functions appear in the User Tools menu when they become ready for use. Time required varies by function. Wait a little longer.
The lamp remains lit and the machine does not enter Sleep mode even though the [Energy Saver] key was pressed.	<ul style="list-style-type: none"> • The ADF is open. • The machine is communicating with external equipment. • The hard disk is active. 	<ul style="list-style-type: none"> • Close the ADF. • Check if the machine is communicating with external equipment. • Wait a little longer.
The display is off.	The machine is in Sleep mode.	Press the [Energy Saver] key or the [Check Status] key to cancel Sleep mode.
Nothing happens when the [Check Status] key or the [Energy Saver] key is pressed.	The main power switch is turned off.	Turn on the main power switch.
"Please wait." appears.	This message appears when you press the [Energy Saver] key.	Wait for a while. If the machine does not get ready in five minutes, contact your service representative.

Problem	Causes	Solutions
"Please wait." appears.	This message appears when the machine is warming up.	<ul style="list-style-type: none"> • Wait until the message disappears. Do not turn off the main power switch while the message is displayed. • If the machine does not get ready in five minutes, contact your service representative.
"Please wait." appears.	This message appears when you change the toner cartridge.	<ul style="list-style-type: none"> • Wait until the message disappears. Do not turn off the main power switch while the message is displayed. • If the message does not disappear in five minutes, contact your service representative.
"Memory is full. Do you want to store scanned file?" appears.	The scanned originals exceed the number of sheets/pages that can be stored on the hard disk.	<ul style="list-style-type: none"> • Press [Yes] to store pages that have been scanned. Delete unnecessary files by pressing [Delete File]. • Press [No] if you are not storing pages that have been scanned. Delete unnecessary files by pressing [Delete File].
The user code entry screen is displayed.	Users are restricted by User Code Authentication.	For details about how to log in when User Code Authentication is enabled, see "When the Authentication Screen is Displayed", Getting Started  .
The Authentication screen appears.	Basic Authentication, Windows Authentication, LDAP Authentication or Integration Server Authentication is set.	Enter your Login User Name and Login Password. For details about the Authentication screen, see "When the Authentication Screen is Displayed", Getting Started  .
"Authentication has failed." appears.	The entered Login User Name or Login Password is not correct.	For details about the correct Login User Name and Login Password, see Security Guide  .
"Authentication has failed." appears.	The machine cannot perform authentication.	For details about authentication, see Security Guide  .

Problem	Causes	Solutions
"You do not have the privileges to use this function." continues to be displayed even though you have entered a valid user name.	The logged in user name does not have permission for the selected function.	For details about how to set permissions, see Security Guide  .
An error message remains, even if misfed paper is removed.	<ul style="list-style-type: none"> • When a misfeed message appears, it remains until you open and close the cover as required. • Paper is still jammed in the tray. 	Remove misfed paper, and then open and close the cover. For details about removing jammed paper, see "Removing Jammed Paper", Troubleshooting  .
An error message remains, even if consumables are replaced and/or misfed paper is removed.	This may occur if the HDD is not installed.	Press the [Start] key.
Original images are printed on the reverse side of the paper.	You may have loaded the paper incorrectly.	<ul style="list-style-type: none"> • Load paper into the paper tray with the print side up. • Load paper into the bypass tray with the print side down.
Misfeeds occur frequently.	The tray's side or end fences may not be set properly.	<ul style="list-style-type: none"> • Remove misfed paper. For details about removing jammed paper, see "Removing Jammed Paper", Troubleshooting . • Check that the side or end fences are set properly. Also, check that the side fences are locked. For details about setting the side and end fences, see "Changing the Paper Size", Paper Specifications and Adding Paper .

Problem	Causes	Solutions
Misfeeds occur frequently.	Copy paper size setting is not correct.	<ul style="list-style-type: none"> Remove misfed paper. For details about removing jammed paper, see "Removing Jammed Paper", Troubleshooting ⑧. Set the proper paper size. For details about specifying paper size with the control panel, see "Changing Paper Size Settings", Paper Specifications and Adding Paper ⑧.
Cannot print in duplex mode.	You have selected a paper tray that is not set for duplex printing.	Change the setting for "Apply 2-sided" in [System Settings] to enable duplex printing for the paper tray. For details about setting "Apply 2-sided", see "Tray Paper Settings", Connecting the Machine/ System Settings ⑧.
Cannot print in duplex mode.	Duplex printing cannot be done with paper set in the bypass tray.	When using duplex printing, make settings to use paper from a tray other than the bypass tray.
"Turn main Power Switch off" appears.	The machine does not shut down normally when the main power switch is turned off, and then immediately turned on.	Turn off the main power switch. Wait for ten seconds or more after the machine shuts down, and then turn it on again.
"Shutting down... Please wait. Main power will be turned off automatically. Maximum waiting time: 2 minute(s)" appears.	The shut down procedure has begun because the main power switch was turned off while the machine was in standby mode or performing an operation.	Follow the message that appears and wait until the machine has shut down. Do not turn on the main power switch while this message is displayed. If the main power switch has been turned on, follow the message that appears. For details about turning the main power switch on and off, see "Turning On/Off the Power", Getting Started ⑧.

Problem	Causes	Solutions
An error has occurred when the Address Book is changed from the display panel or Web Image Monitor.	The Address Book cannot be changed while deleting the multiple stored documents.	Wait a while, and then retry the operation.
Cannot use Web Image Monitor to print documents stored in Document Server.	When print volume limits are specified, users cannot print beyond their print volume limit. Print jobs selected by users who have reached their print volume limits will be canceled.	<ul style="list-style-type: none"> For details about specifying print volume limits, see Security Guide . To view the status of a print job, see [Print Job History]. In Web Image Monitor, click [Job] on the [Status/Information] menu. And then click [Print Job History] in "Document Server".
"Home is in use by another function." appears.	The [Home] screen is being edited by another function.	Wait for a while, and then try to create the shortcut on the [Home] screen again.
"The image data size is not valid. See the manual for required data." appears.	The image data size is not valid.	For details about file size for shortcut image, see "Customizing the [Home] Screen", Convenient Functions  .
"The format of the image data is not valid." appears.	The file format of the shortcut image to be added is not supported.	The file format of shortcut images to be added must be JPEG. Specify the image again.

 **Note**

- If you cannot make copies as you want because of paper type, paper size, or paper capacity problems, use recommended paper. For details about recommended paper, see p.135 "Recommended Paper Sizes and Types".
- Using curled paper often causes misfeeds, soiled paper edges, or slipped positions while performing stack printing. When using curled paper, take the stiffness out of the paper with your hands to straighten out the curl, or load the paper up side down. Also, lay paper on a flat surface to prevent paper from curling, and do not lean it against the wall.



When Messages Are Displayed on the Control Panel

Messages Displayed When Using the Copy/Document Server Function

This section describes the machine's main messages. If other messages appear, follow their instructions.

★ Important

- If you cannot make copies as you want because of the paper type, paper size or paper capacity problems, use recommended paper. For details about recommended paper, see p.135 "Recommended Paper Sizes and Types".
- For messages that are not listed here, see p.149 "When You Have Problems Operating the Machine".

Message	Causes	Solutions
"Check paper size."	An irregular paper size is set.	If you press the [Start] key, the copy will start using the selected paper.
"2 Sided Copy is not available with this paper size. Select another paper size or cancel 2 Sided Copy."	A paper size not available in Duplex mode has been selected.	Select a proper paper size. For details about Duplex mode, see "Duplex Copying", Copy/ Document Server  .
"Exceeded max. number of pages per file. Do you want to store the scanned pages as 1 file?"	The number of scanned pages exceeds the capacity per file of the Document Server.	<ul style="list-style-type: none"> • If you want to store the scanned pages as a file in the Document Server, press [Yes]. • If you do not want to store scanned pages, press [No]. Scanned data is deleted.
"Exceeded the maximum number of sheets that can be used. Copying will be stopped."	The number of pages the user is permitted to copy has been exceeded.	For details about how to check the number of copies available per user, see Security Guide  .
"File being stored exceeded max. number of pages per file. Copying will be stopped."	The scanned originals have too many pages to store as one document.	Press [Exit], and then store again with an appropriate number of pages.

Message	Causes	Solutions
"Maximum number of sets is n." (A figure is placed at n.)	The number of copies exceeds the maximum copy quantity.	You can change the maximum copy quantity from [Max. Copy Quantity] in [General Features] under [Copier/Doc. Srvr. Featr.]. For details about Max. Copy Quantity, see "General Features", Copy/ Document Server  .
"Orig. scanned for diffnt fcnctn."	A function of the machine other than the Copier function is being used such as the Document Server function.	Cancel the job that is being processed. For example, press [Exit], and then press the [Home] key. Next, press the [Document Server] icon on the [Home] screen, and then press the [Stop] key. When the message appears on the screen, follow the instructions to cancel the job.
"Please wait."	The destination list is being updated from the network using Web Image Monitor.	Wait until the message disappears. Do not turn off the main power switch while this message is displayed. Depending on the number of destinations to be updated, there may be some delay before you can resume operation. Operations are not possible while this message is displayed.
"The selected file(s) contained file(s) without access privileges. Only file(s) with access privileges will be deleted."	You have tried to delete files without the authority to do so.	Files can be deleted by the person who created the file. To delete a file which you are not authorized to delete, contact the person who created the file.
"You do not have the privileges to use this function."	The logged in user name does not have permission for the selected function.	For details about how to set permissions, see Security Guide  .

When the memory becomes full while using the copy/document server function

Message	Causes	Solutions
"Memory is full. nn originals have been scanned. Press [Print] to copy scanned originals." "nn" in the message represents a changeable number.	The scanned originals exceed the number of pages that can be stored in memory.	<ul style="list-style-type: none"> • Press [Print] to copy scanned originals and cancel the scanning data. • Press [Clear Memory] to cancel the scanning data and not copy.
"Press [Continue] to scan and copy remaining originals."	The machine checked if the remaining originals should be copied, after the scanned originals were printed.	<ul style="list-style-type: none"> • Remove all copies, and then press [Continue] to continue copying. • Press [Stop] to stop copying.

↓ Note

- If you set [Memory Full Auto Scan Restart] in [Input/Output] of User Tools to [On], even if the memory becomes full, the memory overflow message will not be displayed. The machine will make copies of the scanned originals first, and then automatically proceed to scan and to copy the remaining originals. In this case, the resulting sorted pages will not be sequential. For details about Memory Full Auto Scan Restart, see "Input/Output", Copy/ Document Server .





Messages Displayed When Using the Facsimile Function



This section describes the machine's main messages. If other messages appear, follow their instructions.

↓ Note



- Settings that can be confirmed in System Settings or Facsimile Features on the control panel can also be confirmed from Web Image Monitor. For details about how to confirm the settings from Web Image Monitor, see Web Image Monitor Help.



Message	Causes	Solutions
"Cannot find the specified path. Please check the settings."	The name of the computer or folder entered as the destination is wrong.	Check that the computer name and the folder name for the destination are correct.



Message	Causes	Solutions
"Check whether there are any network problems." [13-10]	The alias telephone number you entered is already registered on the gatekeeper by another device.	<ul style="list-style-type: none"> • Check that the correct alias phone number is listed in [H.323 Settings] of [Facsimile Features]. For details about H.323 Settings, see "Initial Settings", Fax . • For details about network problems, contact your administrator.
"Check whether there are any network problems." [13-11]	Cannot access gatekeeper.	<ul style="list-style-type: none"> • Check that the correct gatekeeper address is listed in [H.323 Settings] of [Facsimile Features]. For details about H.323 Settings, see "Initial Settings", Fax . • For details about network problems, contact your administrator.
"Check whether there are any network problems." [13-17]	Registering of user name is rejected by SIP server.	<ul style="list-style-type: none"> • Check that the correct SIP Server IP Address and SIP User Name are listed in [SIP Settings] of [Facsimile Features]. For details about SIP Settings, see "Initial Settings", Fax . • For details about network problems, contact your administrator.
"Check whether there are any network problems." [13-18]	Cannot access SIP server.	<ul style="list-style-type: none"> • Check that the correct SIP Server IP Address is listed in [SIP Settings] of [Facsimile Features]. For details about SIP Settings, see "Initial Settings", Fax . • For details about network problems, contact your administrator.
"Check whether there are any network problems." [13-24]	The password registered for the SIP server is not the same as the password registered for this machine.	For details about network problems, contact your administrator.



Message	Causes	Solutions
<p>"Check whether there are any network problems." [13-25]</p>	<p>In [Effective Protocol], the IP address is not enabled, or an incorrect IP address has been registered.</p>	<ul style="list-style-type: none"> • Check that "IPv4" in [Effective Protocol] is set to "Active" in [System Settings]. For details about Effective Protocol, see "Interface Settings", Connecting the Machine/ System Settings . • Check that the correct IPv4 address is specified for the machine in [System Settings]. For details about IPv4 address, see "Interface Settings", Connecting the Machine/ System Settings . • For details about network problems, contact your administrator.
<p>"Check whether there are any network problems." [13-26]</p>	<p>The "Effective Protocol" and "SIP Server IP Address" settings are different, or an incorrect IP address has been registered.</p>	<ul style="list-style-type: none"> • Check that the correct IP address is specified for the machine in [System Settings]. For details about IP address, see "Interface Settings", Connecting the Machine/ System Settings . • For details about network problems, contact your administrator.

Message	Causes	Solutions
<p>"Check whether there are any network problems." [14-01]</p>	<p>The DNS server, SMTP server, or folder specified for transfer to was not found, or the destination for Internet Fax around (not through) the SMTP server could not be found.</p>	<ul style="list-style-type: none"> • Check that the following settings in [System Settings] are listed correctly. <ul style="list-style-type: none"> • DNS server • Server name and IP address for the SMTP Server <p>For details about these settings, see "Interface Settings" or "File Transfer", Connecting the Machine/ System Settings .</p> • Check that the folder for transfer is correctly specified. • Check that the computer in which the folder for transfer is specified is correctly operated. • Check that the LAN cable is correctly connected to the machine. • For details about network problems of the destinations, contact the administrator of the destinations. • For details about network problems, contact your administrator.







Message	Causes	Solutions
<p>"Check whether there are any network problems." [14-09]</p>	<p>E-mail transmission was refused by SMTP authentication, POP before SMTP authentication, or login authentication of the computer in which the folder for transfer is specified.</p>	<ul style="list-style-type: none"> • Check that User Name and Password for the following settings in [System Settings] are listed correctly. <ul style="list-style-type: none"> • SMTP Authentication • POP before SMTP • Fax Email Account <p>For details about these settings, see "File Transfer", Connecting the Machine/ System Settings .</p> • Check that the user ID and password for the computer with the folder for forwarding are correctly specified. • Check that the folder for forwarding is correctly specified. • Confirm that the computer with the folder for forwarding is properly working. • For details about network problems, contact your administrator.
<p>"Check whether there are any network problems." [14-33]</p>	<p>E-mail addresses for the machine and the administrator are not registered.</p>	<ul style="list-style-type: none"> • Check that the correct Email Address is listed in [Fax Email Account] of [System Settings]. For details about Fax Email Account, see "File Transfer", Connecting the Machine/ System Settings . • For details about network problems, contact your administrator.



Message	Causes	Solutions
<p>"Check whether there are any network problems." [15-01]</p>	<p>No POP3/IMAP4 server address is registered.</p>	<ul style="list-style-type: none"> • Check that the correct Server Name or Server Address is listed in [POP3/IMAP4 Settings] of [System Settings]. For details about POP3/IMAP4 Settings, see "File Transfer", Connecting the Machine/ System Settings . • For details about network problems, contact your administrator.
<p>"Check whether there are any network problems." [15-02]</p>	<p>Cannot log in to the POP3/IMAP4 server.</p>	<ul style="list-style-type: none"> • Check that the correct User Name and Password are listed in [Fax Email Account] of [System Settings]. For details about Fax Email Account, see "File Transfer", Connecting the Machine/ System Settings . • For details about network problems, contact your administrator.
<p>"Check whether there are any network problems." [15-03]</p>	<p>No machine e-mail address is programmed.</p>	<ul style="list-style-type: none"> • Check that the correct machine e-mail address is specified in [System Settings]. For details about settings of e-mail address, see "File Transfer", Connecting the Machine/ System Settings . • For details about network problems, contact your administrator.





Message	Causes	Solutions
<p>"Check whether there are any network problems." [15-11]</p>	<p>Cannot find the DNS server or POP3/IMAP4 server.</p>	<ul style="list-style-type: none"> • Check that the following settings in [System Settings] are listed correctly. <ul style="list-style-type: none"> • IP address of the DNS Server • the server name or IP address of the POP3/IMAP4 server • the port number of the POP3/IMAP4 server • Reception Protocol <p>For details about these settings, see "Interface Settings" or "File Transfer", Connecting the Machine/ System Settings .</p> • Check that the LAN cable is correctly connected to the machine. • For details about network problems, contact your administrator.
<p>"Check whether there are any network problems." [15-12]</p>	<p>Cannot log in to the POP3/IMAP4 server.</p>	<ul style="list-style-type: none"> • Check that the following settings in [System Settings] are listed correctly. <ul style="list-style-type: none"> • the user name and password for [Fax Email Account] • the user name and password for POP before SMTP authentication <p>For details about these settings, see "File Transfer", Connecting the Machine/ System Settings .</p> • For details about network problems, contact your administrator.





Message	Causes	Solutions
"Connection with LDAP server has failed. Check the server status."	A network error has occurred and connection has failed.	Try the operation again. If the message is still shown, the network may be busy. Check the settings for LDAP server in [System Settings]. For details about settings for LDAP server, see "Programming the LDAP server", Connecting the Machine/ System Settings  .
"Error occurred, and transmission was cancelled."	<ul style="list-style-type: none"> • Original jammed during Immediate Transmission. • A problem occurred in the machine, or noise occurred on the telephone line. 	Press [Exit], and then send the documents again.
"Exceeded max. number to display. Max. No.: n" (A figure is placed at n.)	The number of search results has exceeded the maximum number of items that can be displayed.	Search again after changing the search conditions.
"Exceeded time limit for LDAP server search. Check the server status."	A network error has occurred and connection has failed.	<ul style="list-style-type: none"> • Try the operation again. If the message is still shown, the network may be busy. • Check that the correct settings for LDAP server are listed in [Administrator Tools] of [System Settings]. For details about LDAP server, see "Programming the LDAP server", Connecting the Machine/ System Settings .

Message	Causes	Solutions
"Functional problem occurred. Stopped processing."	The main power switch was turned off while the machine was receiving a document by Internet Fax.	Even if you turn the main power switch back on immediately, depending on the mail server, the machine might not be able to resume reception of the Internet Fax if the timeout period has not expired. Wait until the mail server's timeout period has expired, and then resume reception of the Internet Fax. For details about reception of the Internet Fax, contact your administrator.
"Functional problems with facsimile. Data will be initialized."	There is a problem with the fax.	Record the code number shown on the screen, and then contact your service representative. Other functions can be used.
"LDAP server authentication has failed. Check the settings."	A network error has occurred and connection has failed.	Make settings correctly for the user name and the password for LDAP server authentication.
"Orig. scanned for diffrent fcnctn."	A function of the machine other than the Facsimile function is being used such as the Document Server function.	Before sending a file by fax, cancel the job in progress. For example, press [Exit], and then press the [Home] key. Press the [Document Server] icon on the [Home] screen. Next, press the [Stop] key. When the message appears on the screen, follow the instructions to cancel the job.
"Put original back, check it and press the Start key."	Original jammed during Memory Transmission.	Press [Exit], and then send the documents again.
"Some invalid destination(s) contained. Do you want to select only valid destination(s)?"	The specified group contains fax destinations, e-mail destinations, and/or folder destinations, either of which are incompatible with the specified transmission method.	In the message that appears at each transmission, press [Select].



Message	Causes	Solutions
"Some page(s) are almost blank. To cancel press the Stop key."	The first page of the document is almost blank.	The original's blank side might have been scanned. Be sure to place your originals correctly. For details about determining the cause of blank pages, see "Detecting Blank Pages", Fax  .
"The selected file(s) contained file(s) without access privileges. Only file(s) with access privileges will be deleted."	You tried to delete a document for which you do not have permission to delete.	To check your access permission for stored documents, or to delete a document you do not have permission to delete, see Security Guide  .
"Updating the destination list... Please wait. Specified destination(s) or sender's name has been cleared."	The destination list is being updated from the network using Web Image Monitor.	Wait until the message disappears. Do not turn off the main power switch while this message is displayed. Depending on the number of destinations to be updated, there may be some delay before you can resume operation. Operation is not possible while this message is displayed.
"You do not have the privileges to use this function."	The logged in user name does not have permission for the selected function.	For details about how to set permissions, see Security Guide  .
"The destination cannot be selected because its certificate is not currently valid."	The user certificate (destination certificate) has expired.	A new user certificate must be installed. For details about the user certificate (destination certificate), see Security Guide  .
"The group destination cannot be selected because it contains a destination with a certificate that is not currently valid."	The user certificate (destination certificate) has expired.	A new user certificate must be installed. For details about the user certificate (destination certificate), see Security Guide  .
"Transmission cannot be performed because the certificate used for the S/MIME signature is not currently valid."	The device certificate (S/MIME) has expired.	A new device certificate (S/MIME) must be installed. For details about how to install a device certificate (S/MIME), see Security Guide  .

Message	Causes	Solutions
"The program contains a destination(s) with a certificate that is not currently valid. The destination(s) cannot be recalled."	The user certificate (destination certificate) has expired.	A new user certificate must be installed. For details about the user certificate (destination certificate), see Security Guide  .
"The specified destination for Email TX Result, which is registered to the program, has a certificate that is not currently valid. The destination cannot be recalled."	The user certificate (destination certificate) has expired.	A new user certificate must be installed. For details about the user certificate (destination certificate), see Security Guide  .
"The specified dest. for Email TX Result, which is registered to program, contains a dest. that has a certificate that is not currently valid. The dest. cannot be recalled."	The user certificate (destination certificate) has expired.	A new user certificate must be installed. For details about the user certificate (destination certificate), see Security Guide  .
"Transmission cannot be performed because the certificate for encryption is not currently valid."	The user certificate (destination certificate) has expired.	A new user certificate must be installed. For details about the user certificate (destination certificate), see Security Guide  .
"XXX cannot be YYY because the device certificate used for the S/MIME signature is not currently valid." (XXX and YYY indicate the user action.)	The device certificate (S/MIME) has expired.	A new device certificate (S/MIME) must be installed. For details about how to install a device certificate (S/MIME), see Security Guide  .
"Email TX Result cannot be set because the specified destination's certificate is not currently valid."	The user certificate (destination certificate) has expired.	For details about the user certificate (destination certificate), see Security Guide  .

Message	Causes	Solutions
"The program contains a destination(s) that does not have a certificate."	There is no user certificate (destination certificate).	For details about the user certificate (destination certificate), see Security Guide  .
"The specified destination for Email TX Result, which is registered to the program, has no certificate for encryption."	There is no user certificate (destination certificate).	For details about the user certificate (destination certificate), see Security Guide  .
"The specified destinations for Email TX Result, which is registered to the program, contain a destination(s) that has no certificate for encryption."	There is no user certificate (destination certificate).	For details about the user certificate (destination certificate), see Security Guide  .
"The device certificate used for the S/MIME signature is not currently valid. XXX which is registered to the program cannot be recalled." (XXX indicates the e-mail destination(s) or destination(s) for [Email TX Results].)	The device certificate (S/MIME) has expired.	For details about the device certificate (S/MIME), see Security Guide  .
"XXX cannot be YYY because there is a problem with the device certificate used for the S/MIME signature. Check the device certificate." (XXX and YYY indicate the user action.)	There is no device certificate (S/MIME), or the certificate is invalid.	For details about the device certificate (S/MIME), see Security Guide  .

Message	Causes	Solutions
<p>"XXX cannot be recalled because there is a problem with the device certificate used for the S/MIME signature."</p> <p>(XXX indicates the e-mail destination(s) or destination(s) for [Email TX Results].)</p>	There is no device certificate (S/MIME), or the certificate is invalid.	For details about the device certificate (S/MIME), see Security Guide  .
<p>"The PDF Digital Signature's device certificate is not currently valid. The email destination(s) which is registered to the program cannot be recalled."</p>	The device certificate (PDF with digital signature) has expired.	A new device certificate (PDF with digital signature) must be installed. For details about how to install a device certificate (PDF with digital signature), see Security Guide  .
<p>"XXX cannot be YYY because the PDF Digital Signature's device certificate is not currently valid."</p> <p>(XXX and YYY indicate the user action.)</p>	The device certificate (PDF with digital signature) has expired.	A new device certificate (PDF with digital signature) must be installed. For details about how to install a device certificate (PDF with digital signature), see Security Guide  .
<p>"XXX cannot be YYY because there is a problem with the PDF Digital Signature's device certificate. Check the device certificate."</p> <p>(XXX and YYY indicate the user action.)</p>	There is no device certificate (PDF with digital signature), or the certificate is invalid.	A new device certificate (PDF with digital signature) must be installed. For details about how to install a device certificate (PDF with digital signature), see Security Guide  .
<p>"The email destination(s) which is registered to the program cannot be recalled because there is a problem with the PDF Digital Signature's device certificate."</p>	There is no device certificate (PDF with digital signature), or the certificate is invalid.	A new device certificate (PDF with digital signature) must be installed. For details about how to install a device certificate (PDF with digital signature), see Security Guide  .

↓ Note

- If "Check whether there are any network problems." appears, the machine is not correctly connected to the network or the settings of the machine are not correct. If you do not need to connect to a network, you can specify the setting so this message is not displayed, and then the [Check Status] key no longer lights. For details about how to do this, see "Parameter Settings", Fax . If you reconnect the machine to the network, be sure to set "Display" by configuring the appropriate User Parameter.
- If the paper tray runs out of paper, "Cannot print fax message. Load paper." appears on the screen, asking you to add paper. If there is paper left in the other trays, you can receive documents as usual, even if the message appears on the screen. You can turn this function on or off with "Parameter Settings". For details about how to do this, see "Parameter Settings", Fax .

When the memory becomes full while using the facsimile function

Message	Causes	Solutions
"Memory is full. Cannot scan more. Transmission will be stopped."	The memory is full.	If you press [Exit], the machine returns to standby mode and starts transmitting the stored pages. Check the pages that have not been sent using the Communication Result Report, and then resend those pages.

Messages Displayed When Using the Printer Function

This section describes the principal messages that appear on the display panel, error logs or reports. If other messages appear, follow their instructions.

Status messages

Message	Status
"Hex Dump Mode"	In Hex Dump mode, the machine receives data in hexadecimal format. Press [Job Reset] to cancel Hex Dump mode.
"Suspended job exists."	Printing was temporarily stopped by SmartDeviceMonitor for Client. You can resume printing via [My Job List] in SmartDeviceMonitor for Client, or via the Web Image Monitor. To resume printing via Web Image Monitor, ask your system administrator first.

Message	Status
"Offline"	The machine is offline.
"Please wait."	This message might appear for a second or two while the machine is preparing, performing initial adjustments, or adding toner. Wait a while.
"Printing..."	The machine is printing. Wait a while.
"Ready"	This is the default ready message. The machine is ready for use. No action is required.
"Resetting job..."	The machine is resetting the print job. Wait until "Ready" appears on the display panel.
"Setting change..."	The machine is changing settings. You cannot use the control panel while this message is displayed. Wait a while.
"Waitg. for prt.data"	The machine is waiting for the next data to print. Wait a while.
"Job suspended."	Printing was temporarily suspended because [Job Operation] or the [Stop] key was pressed.
"Updating certif..."	The @Remote certificate is being updated. Wait a while.

Messages displayed on the control panel when using the printer function



↓ Note



- Before turning the main power switch off, see p.48 "Turning On/Off the Power".

10

Message	Causes	Solutions
"Cannot connect with the wireless card. Turn the main power switch off, then check the card."	<ul style="list-style-type: none"> • The wireless LAN board was not inserted when the machine was turned on. • The wireless LAN board was pulled out after the machine was turned on. • The settings are not updated although the unit is detected. 	Turn off the main power switch, and then confirm the wireless LAN board is inserted correctly. And then, turn on the main power switch again. If the message appears again, contact your service representative.

Message	Causes	Solutions
"Cannot connect with the Bluetooth interface. Check the Bluetooth interface."	<ul style="list-style-type: none"> The Bluetooth interface unit was installed while the machine was turned on. The Bluetooth interface unit was removed while the machine was turned on. 	Turn off the main power switch, and then confirm that the Bluetooth interface unit was installed correctly. And then, turn on the main power switch again. If the message appears again, contact your service representative.
"Hardware Problem: Ethernet"	An error has occurred in the Ethernet interface.	Turn off the main power switch, and then back on again. If the message appears again, contact your service representative.
"Hardware Problem: HDD"	An error has occurred in the hard disk.	Turn off the main power switch, and then back on again. If the message appears again, contact your service representative.
"Hardware Problem: Parallel I/F"	An error has occurred in the IEEE 1284 interface board.	Turn off the main power switch, and then back on again. If the message appears again, contact your service representative.
"Hardware Problem: USB"	An error has occurred in the USB interface.	Turn off the main power switch, and then back on again. If the message appears again, contact your service representative.
"Hardware Problem: Wireless Card" (A "wireless LAN board" or "Bluetooth interface unit" is referred to as a "wireless card".)	The wireless LAN board can be accessed, but an error was detected.	Turn off the main power switch, and then confirm the wireless LAN board is inserted correctly. And then, turn on the main power switch again. If the message appears again, contact your service representative.

Message	Causes	Solutions
<p>"Hardware Problem: Wireless Card"</p> <p>(A "wireless LAN board" or "Bluetooth interface unit" is referred to as a "wireless card".)</p>	<ul style="list-style-type: none"> • The Bluetooth interface unit was connected while the machine was turned on. • The Bluetooth interface unit was removed while the machine was turned on. 	<p>Turn off the main power switch, and then confirm the Bluetooth interface unit is inserted correctly. And then, turn on the main power switch again. If the message appears again, contact your service representative.</p>
<p>"Out of paper in n. Load paper of the following size and type. To cancel the current job, press [Job Reset]."</p> <p>(A figure is placed at n.)</p>	<p>The printer driver settings are incorrect or the tray does not contain paper of the size selected in the printer driver.</p>	<p>Check that the printer driver settings are correct, and then load paper of the size selected in the printer driver into the input tray. For details about how to change the paper size, see "Changing the Paper Size", Paper Specifications and Adding Paper .</p>
<p>"Tray setg. do not match spcfd siz&yp. Select new tray or use sz&typ below."</p>	<p>The printer driver settings are incorrect or the tray does not contain paper of the size or type selected in the printer driver.</p>	<ul style="list-style-type: none"> • Check that the printer driver settings are correct, and then load paper of the size selected in the printer driver into the input tray. For details about how to change the paper size, see "Changing the Paper Size", Paper Specifications and Adding Paper . • Select the tray manually to continue printing, or cancel a print job. For details about how to select the tray manually, or cancel a print job, see "If an Error Occurs with the Specified Paper Size and Type", Print .
<p>"n ppr siz msmtch Select new tray or use ppr size below."</p> <p>(A tray name is placed at n.)</p>	<p>The size of the paper in the tray does not match the paper size specified in the printer driver.</p>	<p>Select a tray containing paper that is the same size as the specified paper size.</p>
<p>"Problem: Printer Font Error"</p>	<p>An error has occurred in the font settings.</p>	<p>Contact your service representative.</p>

Message	Causes	Solutions
"Problems with the wireless board. Please call service." (A "wireless LAN board" or "Bluetooth unit" is referred to as a "wireless board".)	The machine has detected a Bluetooth failure, or it could not detect a Bluetooth unit. It may be incorrectly installed.	Check that the Bluetooth unit is installed properly, or contact your service representative.
"The selected file(s) contained file(s) without access privileges. Only file(s) with access privileges will be deleted."	You have tried to delete files without the authority to do so.	To check your access permission for stored documents, or to delete a document you do not have permission to delete, see Security Guide  .
"Updating the destination list... Please wait. Specified destination(s) or sender's name has been cleared."	The destination list is being updated from the network using Web Image Monitor.	Wait until the message disappears. Do not turn off the main power switch while this message is displayed. Depending on the number of destinations to be updated, there may be some delay before you can resume operation. Operations are not possible while this message is displayed.
"You do not have the privileges to use this function."	The logged in user name does not have permission for the selected function.	For details about how to set permissions, see Security Guide  .

Messages during Direct print from a removable memory device

Message	Causes	Solutions
"Unable to access the specified memory storage device."	The memory device used cannot be recognized.	For details about the recommended memory devices for the Direct printing function from removable memory devices, contact your service representative. The USB flash memory that features password protection or other security features may not work normally.

Message	Causes	Solutions
"Exceeded the limit value for total data size of the selected files. Cannot select more files."	<ul style="list-style-type: none"> The size of the selected file exceeds 1 GB. The total size of the selected files exceeds 1 GB. 	<p>Files or groups of files larger than 1 GB cannot be printed.</p> <ul style="list-style-type: none"> When the total size of the multiple files that are selected exceeds 1 GB, select files separately. When the size of selected file exceeds 1 GB, print by using a function other than the Direct printing function from removable memory devices. <p>You cannot select files of different formats at the same time.</p>



Other messages

This section describes likely causes of and possible solutions for the error messages that are printed on the error logs or reports.

Message	Causes	Solutions
"86: Error"	Parameters of the control code are invalid.	Check the print settings.
"91: Error"	Printing was canceled by the auto job cancel function due to a command error.	Check that the data is valid.
"92: Error"	Printing was canceled because [Job Reset] or the [Stop] key was selected on the machine's control panel.	Perform the print operation again if necessary.
"98: Error"	The machine could not access the hard disk correctly.	Turn off the main power switch, and then back on again. If the message appears frequently, contact your service representative.

Message	Causes	Solutions
"Address Book is currently in use by another function. Authentication has failed."	The machine currently cannot perform authentication because the Address Book is being used by another function.	Wait a while, and then retry the operation.
"Unauthorized Copy Prevention error occurred. Job cancelled."	You tried to store a file in the Document Server when [Unauthorized Copy Prevention] was specified.	Only when using PCL 6 / PostScript 3 On the printer driver, select a job type other than [Document Server] in "Job Type:" or deselect [Unauthorized Copy Prevention].
"Unauthorized Copy Prevention error occurred. Job cancelled."	The [Enter User Text:] field on the [Unauthorized Copy Prevention for Pattern Details] screen is blank.	Only when using PCL 6 / PostScript 3 On the printer driver's [Detailed Settings] tab, click [Effects] in "Menu:". Select [Unauthorized Copy Prevention], and then click [Details] to display [Unauthorized Copy Prevention for Pattern Details]. Enter text in [Enter User Text:].
"Auto-registration of user information has failed."	Automatic registration of information for LDAP Authentication or Windows Authentication failed because the Address Book is full.	For details about automatic registration of user information, see Security Guide  .
"Cannot store data of this size."	The paper size exceeded the capacity of the Document Server.	Reduce the paper size of the file that you want to send to a size that the Document Server can store. Custom size files can be sent but not stored afterward.
"Classification Code is incorrect."	The classification code has not been entered, or the classification code has been entered incorrectly.	Enter the correct classification code.



Message	Causes	Solutions
"Classification Code is incorrect."	The classification code is not supported with the printer driver.	Select Optional for classification code. For details about how to specify classification code settings, see "Configuring Classification Codes", Print  .
"Collate has been cancelled."	Collate was canceled.	Turn off the main power switch, and then back on again. If the message appears again, contact your service representative.
"Command Error"	An RPCS command error occurred.	<ul style="list-style-type: none"> • Check if the communication between the computer and the machine is working correctly. • Check if the correct printer driver is being used. • Check if the machine's memory size is set correctly in the printer driver. • Check that the printer driver is the most up-to-date version available.
"Compressed Data Error."	The printer detected corrupt compressed data.	<ul style="list-style-type: none"> • Check the connection between the computer and the printer. • Check that the program you used to compress the data is functioning correctly.
"Data storage error."	You tried to print a Sample Print, Locked Print, Hold Print, or Stored Print file, or to store a file in the Document Server when the hard disk was malfunctioning.	Contact your service representative.

Message	Causes	Solutions
"Document Server is not available to use. Cannot store."	You cannot use the Document Server function.	<ul style="list-style-type: none"> For details about using Document Server function, contact your administrator. For details about how to set permissions, see Security Guide .
"Duplex has been cancelled."	Duplex printing was canceled.	<ul style="list-style-type: none"> Select the proper paper size for the duplex function. For details about paper, see "Specifications for the Main Unit", Maintenance and Specifications . Change the setting for "Apply 2-sided" in [System Settings] to enable duplex printing for the paper tray. For details about setting "Apply 2-sided", see "Tray Paper Settings", Connecting the Machine/ System Settings .
"Error has occurred."	A syntax error, etc., occurred.	Check that the PDF file is valid.
"Exceeded max. capacity of Document Server. Cannot store."	The hard disk became full after a file was stored.	Delete some of the files stored in the Document Server or reduce the size that you want to send.
"Exceeded max. number of files of Document Server. Cannot store."	The maximum file capacity of the Document Server was exceeded.	Delete some of the files stored in the Document Server.
"Exceeded max. number of files to print for temporary/ stored jobs."	While printing a Sample Print, Locked Print, Hold Print, or Stored Print file, the maximum file capacity was exceeded.	Delete unneeded files stored in the machine.

Message	Causes	Solutions
"Exceeded max. number of files. (Auto)"	While using the error job store function to store Normal Print jobs as Hold Print files, the maximum file capacity for file storage or Hold Print file management (automatic) was exceeded.	Delete Hold Print files (automatic) or unneeded files stored in the machine.
"Exceeded max. number of pages of Document Server. Cannot store."	The maximum page capacity of the Document Server was exceeded.	Delete some of the files stored in the Document Server or reduce the number of pages that you want to send.
"Exceeded max. number of pages to print for temporary/stored jobs."	While printing a Sample Print, Locked Print, Hold Print, or Stored Print file, the maximum page capacity was exceeded.	<ul style="list-style-type: none"> • Delete unneeded files stored in the machine. • Reduce the number of pages to print.
"Exceeded max. pages. Collate is incomplete."	The number of pages exceeds the maximum number of sheets that you can use Collate with.	Reduce the number of pages to print.
"Exceeded max. number of pages. (Auto)"	While using the error job store function to store Normal Print jobs as Hold Print files, the maximum page capacity was exceeded.	<ul style="list-style-type: none"> • Delete unneeded files stored in the machine. • Reduce the number of pages to print.
"Exceeded the maximum unit count for Print Volume Use. The job has been cancelled."	The number of pages the user is permitted to print has been exceeded.	For details about Print Volum. Use Limit., see Security Guide  .
"Failed to obtain file system."	PDF direct printing could not be performed because the file system could not be obtained.	Turn off the main power switch, and then back on again. If the message appears again, contact your service representative.
"File system is full."	PDF file does not print out because the capacity of the file system is full.	Delete all unnecessary files from the hard disk, or decrease the file size sent to the machine.

Message	Causes	Solutions
"HDD is full."	The hard disk became full while printing a Sample Print, Locked Print, Hold Print, or Stored Print file.	<ul style="list-style-type: none"> • Delete unneeded files stored in the machine. • Reduce the data size of the Sample Print, Locked Print, Hold Print, or Stored Print file.
"HDD is full."	When printing with the PostScript 3 printer driver, the hard disk capacity for fonts and forms has been exceeded.	Delete unneeded forms or fonts registered in the machine.
"HDD is full. (Auto)"	The hard disk became full while using the error job store function to store Normal Print jobs as Hold Print files.	<ul style="list-style-type: none"> • Delete unneeded files stored in the machine. • Reduce the data size of the Temporary Print file and/or the Stored Print file.
"I/O buffer overflow."	An input buffer overflow occurred.	<ul style="list-style-type: none"> • In [Printer Features], under [System], set [Memory Usage] to [Font Priority]. • In [Printer Features], under [Host Interface], select [I/O Buffer], and then set the maximum buffer size to a larger value. • Reduce the number of files being sent to the machine.
"Information for user authentication is already registered for another user."	The user name for LDAP Authentication or Integration Server Authentication was already registered in a different server with a different ID, and a duplication of the user name occurred due to a switching of domains (servers), etc.	For details about User Authentication, see Security Guide  .

Message	Causes	Solutions
"Insufficient Memory"	A memory allocation error occurred.	<p>PCL 5e</p> <p>Select a lower resolution on the printer driver. For details about how to change the resolution setting, see the printer driver Help.</p> <p>PCL 6</p> <p>On the printer driver's [Detailed Settings] tab, click [Print Quality] in "Menu:", and then select [Raster] in the "Vector/Raster:" list. In some cases, it will take a long time to complete a print job.</p>
"Memory Retrieval Error"	A memory allocation error occurred.	Turn off the main power switch, and then back on again. If the message appears again, replace the RAM. For details about replacing the RAM, contact your service representative.
"No response from the server. Authentication has failed."	A timeout occurred while connecting to the server for LDAP Authentication or Windows Authentication.	Check the status of the server.
"Output tray has been changed."	The output tray was changed because the paper size of the specified output tray is limited.	Specify the proper output tray.
"Print overrun."	Images were discarded while printing.	<p>PCL 5e</p> <p>Select a lower resolution on the printer driver. For details about how to change the resolution setting, see the printer driver Help.</p>
"Printing privileges have not been set for this document."	The PDF document you have tried to print has no privileges to print.	Contact the owner of the document.
"Receiving data failed."	Data reception was aborted.	Resend the data.

Message	Causes	Solutions
"The selected paper size is not supported. This job has been cancelled."	Job Reset is automatically performed if the specified paper size is incorrect.	Specify the correct paper size, and then print the file again.
"Sending data failed."	The machine received a command to stop transmission from the printer driver.	Check if the computer is working correctly.
"The print job has been cancelled because capture file(s) could not be stored: Exceeded max. memory."	The hard disk became full after a file was stored.	Delete the files stored in the Document Server or reduce the file size to be sent.
"The print job has been cancelled because capture file(s) could not be stored: Exceeded max. number of files."	The maximum file capacity of the Document Server was exceeded.	Delete the files stored in the Document Server.
"The print job has been cancelled because capture file(s) could not be stored: Exceeded max. No. of pages per file."	The maximum page capacity of the Document Server was exceeded.	Delete some of the files stored in the Document Server or reduce the number of pages that you want to send.
"The selected paper type is not supported. This job has been cancelled."	Job Reset is automatically performed if the specified paper type is incorrect.	Specify the correct paper type, and then print the file again.
"You do not have a privilege to use this function. This job has been cancelled."	The entered Login User Name or Login Password is not correct.	Check that the Login User Name and Login Password are correct.
"You do not have a privilege to use this function. This job has been cancelled."	The logged in user is not allowed to use the selected function.	For details about how to set permissions, see Security Guide  .
"You do not have a privilege to use this function. This operation has been cancelled."	The logged in user does not have the privileges to register programs or change the paper tray settings.	For details about how to set permissions, see Security Guide  .

Messages during Direct print from a removable memory device

Message	Causes	Solutions
"99: Error"	This data cannot be printed. The specified data is either corrupt or not supported by the Direct printing function from removable memory devices.	Check that the data is valid. For details about the kinds of data supported by the Direct printing function from removable memory devices, see "Direct Printing from a Removable Memory Device", Print  .

If printing does not start, contact your service representative.

Note



- The contents of errors may be printed on the Configuration Page. Check the Configuration Page in conjunction with the error log. For details about how to print the Configuration Page, see "List / Test Print", Print .



Messages Displayed When Using the Scanner Function

This section describes likely causes of and possible solutions for the error messages that appear on the control panel. If a message not described here appears, act according to the message.

Message	Causes	Solutions
"Authentication with the destination has failed. Check settings. To check the current status, press [Comm. Status/Print]."	The entered user name or password was invalid.	<ul style="list-style-type: none"> Check that the user name and password are correct. Check that the ID and password for the destination folder are correct. A password of 128 or more characters may not be recognized.
"Cannot communicate with PC. Contact the administrator."	WSD (Device) protocol or WSD (Scanner) protocol is disabled.	For details about how to enable or disable the WSD protocol, see Security Guide  .





Message	Causes	Solutions
"Connection with the destination has failed. Check the settings. Entered path name might be incorrect, or firewall and security settings might be blocking network connectivity."	The destination computer name or folder name is invalid.	Check whether the computer name and the folder name for the destination are correct.
"Connection with the destination has failed. Check the settings. Entered path name might be incorrect, or firewall and security settings might be blocking network connectivity."	An antivirus program or a firewall is preventing the machine connecting to your computer.	<p>Antivirus programs and firewalls can prevent client computers from establishing connection with this machine.</p> <ul style="list-style-type: none"> • If you are using anti-virus software, add the program to the exclusion list in the application settings. For details about how to add programs to the exclusion list, see the anti-virus software Help. • To prevent a firewall blocking the connection, register the machine's IP address in the firewall's IP address exclusion settings. For details about the procedure for excluding an IP address, see your firewall's Help.
"Cannot start scanning because communication was failed."	Scan Profile is not set on the client computer.	Set Scan Profile. For details about how to do this, see "Changing a Scan Profile", Scan  .
"Cannot start scanning because communication was failed."	The [Take no action] setting has been selected on the client computer, forcing the client computer to remain inactive when it receives scan data.	Open scanner properties, click the [Events] tab, and then select [Start this program] as the computer's response on receipt of scan data. For details, see your operating system's Help.
"Cannot start scanning. Check the setting(s) on the PC."	The Scan Profile might be incorrectly configured.	Check the Scan Profile configuration.



Message	Causes	Solutions
<p>"Cannot write on the memory storage device. Check the memory storage device and machine settings."</p>	<p>The memory device is faulty, or the file name contains a character that cannot be used.</p>	<ul style="list-style-type: none"> • Check to see if the memory device is defective. • Check the memory device. It might be unformatted, or its format might be incompatible with this machine. • Check the file name set at the time of scanning. For details about the characters that can be used in file names, see "Available Characters and How to Enter Them", Getting Started .
<p>"Cannot write on the memory storage device because remaining free space is insufficient."</p>	<ul style="list-style-type: none"> • The memory device is full and scan data cannot be saved. • Even if the memory device appears to have sufficient free space, data might not be saved if the maximum number of files that can be saved is exceeded. 	<ul style="list-style-type: none"> • Replace the memory device. • If the document is scanned as single-page or divided multiple pages, data already written to the memory device is saved as is. Replace the memory device, and then press [Retry] to save the remaining data, or press [Cancel] to redo the scan.
<p>"Cannot write on the memory storage device because the device is write-protected."</p>	<p>The memory device is write-protected.</p>	<p>Unlock the write-protection on the memory device.</p>
<p>"Connection with LDAP server has failed. Check the server status."</p>	<p>A network error has occurred and connection has failed.</p>	<ul style="list-style-type: none"> • Try the operation again. If the message is still shown, the network may be busy. • Check that the correct settings for LDAP server are listed in [Administrator Tools] of [System Settings]. For details about LDAP server, see "Programming the LDAP server", Connecting the Machine/ System Settings .

Message	Causes	Solutions
"The data could not be sent because the PC timed out before it was sent."	A time out occurred when using WSD Scanner. Time outs occur when too much time passes between scanning an original and sending its data. The followings are likely causes of time outs: <ul style="list-style-type: none"> • Too many originals per set. • Misfed originals. • Transmission of other jobs. 	<ul style="list-style-type: none"> • Reduce the number of originals, and then scan again. • Remove any misfed original, and then scan again. • Use Scanner Journal to check there are no jobs awaiting transmission, and then scan again.
"Entered protection code for destination is incorrect. Please re-enter."	The correct protection code was not entered.	Make sure the protection code is correct, and then enter it again. For details about a protection code, see "Registering a Protection Code", Connecting the Machine/ System Settings  .
"Entered user code is not correct. Please re-enter."	You have entered an incorrect user code.	Check the authentication settings, and then enter a correct user code.
"Exceeded max. email size. Sending email has been cancelled. Check [Max. Email Size] in Scanner Features."	The file size per page has reached the maximum e-mail size specified in [Scanner Features].	Change the [Scanner Features] settings as follows: <ul style="list-style-type: none"> • Increase the e-mail size limit in [Max. Email Size]. • Change the [Divide & Send Email] setting to [Yes (per Page)] or [Yes (per Max. Size)]. For details about these settings, see "Send Settings", Scan .
"Exceeded max. number to display. Max. No.: n" (A figure is placed at n.)	Search results have exceeded the max. displayable number.	Search again after changing the search conditions.

Message	Causes	Solutions
"Exceeded max. data capacity. Check the scanning resolution, then press the Start key again."	The scanned data exceeded maximum data capacity.	Specify the scan size and resolution again. Note that it may not be possible to scan very large originals at a high resolution. For details about the settings for scan function, see "Relationship between Resolution and Scan Size", Scan  .
"Exceeded max. data capacity. Check resolution, then reset n orig." (A figure is placed at n.)	The scanned original exceeded maximum data capacity.	Specify the scan size and resolution again. Note that it may not be possible to scan very large originals at a high resolution. For details about the settings for scan function, see "Relationship between Resolution and Scan Size", Scan  .
"Exceeded max. number of alphanumeric characters for the path."	The maximum number of specifiable alphanumeric characters in a path has been exceeded.	The maximum number of characters which can be entered for the path is 256. Check the number of characters you entered, and then enter the path again.
"Exceeded max. number of alphanumeric characters."	The maximum enterable number of alphanumeric characters has been exceeded.	Check the maximum number of characters which can be entered, and then enter it again. For details about the maximum enterable number of characters, see "Values of Various Set Items for Transmission/Storage/Delivery Function", Scan  .
"Exceeded max. number of files which can be sent at the same time. Reduce the number of the selected files."	The number of files exceeded the maximum number possible.	Reduce the number of files, and then send them again.
"Exceeded max. number of files which can be used in Document Server at the same time."	The maximum number of files that can be stored in the Document Server has been exceeded.	Check the files stored by the other functions, and then delete unneeded files. For details about how to delete files, see "Deleting Stored Documents", Copy/ Document Server  .

Message	Causes	Solutions
"Exceeded max. number of pages per file. Do you want to store the scanned pages as 1 file?"	The file being stored has exceeded the maximum number of pages for one file.	Specify whether to store the data or not. Scan the pages that were not scanned, and then store them as a new file. For details about storing files, see "Storing and Saving the Scanned Documents", Scan  .
"Exceeded max. number of standby files. Try again after the current file is sent."	The maximum number of standby files was exceeded.	There are 100 files waiting in the sending queue for e-mail, Scan to Folder, or delivery functions. Wait until files have been sent.
"Exceeded max. number of stored files. Cannot send the scanned data as capturing files is unavailable."	Too many files are waiting to be delivered.	Try again after they have been delivered.
"Exceeded max. page capacity per file. Press [Send] to send the scanned data, or press [Cancel] to delete."	The number of scanned pages exceeded the maximum page capacity.	Select whether to send the data that has already been scanned.
"Exceeded max. page capacity per file. Press [Write] to write the scanned data to the memory storage device, or press [Cancel] to delete."	The scan could not be completed because the maximum number of pages that can be scanned by this machine was exceeded during writing to the memory device.	Reduce the number of documents to be written to the memory device, and then try again.
"Exceeded maximum number of files to store. Delete all unnecessary files."	Too many files are waiting to be delivered.	Try again after they have been delivered.

Message	Causes	Solutions
"Exceeded time limit for LDAP server search. Check the server status."	A network error has occurred and connection has failed.	<ul style="list-style-type: none"> Try the operation again. If the message is still shown, the network may be busy. Check that the correct settings for LDAP server are listed in [Administrator Tools] of [System Settings]. For details about LDAP server, see "Programming the LDAP server", Connecting the Machine/ System Settings .
"LDAP server authentication has failed. Check the settings."	The user name and password differ from those set for LDAP Authentication.	For details about LDAP Authentication, see Security Guide  .
"Memory device error occurred. Check the memory device."	A non-writable medium is being used.	Use a different medium.
"Memory is full. Cannot scan. The scanned data will be deleted."	Because of insufficient hard disk space, the first page could not be scanned.	<ul style="list-style-type: none"> Wait for a while, and then retry the scan operation. Reduce the scan area or scanning resolution. For details about changing scan area and scanning resolution, see "Various Scan Settings", Scan . Delete unneeded stored files. For details about how to delete stored files, see "Deleting a Stored File", Scan .
"Memory is full. Do you want to store scanned file?"	Because there is not enough free hard disk space in the machine for storing in the Document Server, only some of the pages could be scanned.	Specify whether to use the data or not.



Message	Causes	Solutions
"Memory is full. Press [Write] to write the current scanned data to the memory storage device, or press [Cancel] to delete."	The scan could not be completed because there was insufficient hard disk memory at the time of saving to the memory device.	Select whether or not to save the scanned document to the memory device.
"Memory is full. Scanning has been cancelled. Press [Send] to send the scanned data, or press [Cancel] to delete."	Because there is not enough free hard disk space in the machine for delivering or sending by e-mail while storing in the Document Server, only some of the pages could be scanned.	Specify whether to use the data or not.
"Memory storage device not detected. Insert the device."	There is no memory device inserted.	Insert a memory device, or check to see whether the memory device is properly inserted in the media slot.
"No paper. Load paper of one of the following sizes."	No paper is set in the specified paper tray.	Load paper of the sizes listed in the message. For details about loading paper, see "Loading Paper", Paper Specifications and Adding Paper  .
"Orig. scanned for diffrent fnctn."	A function of the machine other than the Scanner function is being used such as the Copier function.	Cancel the job that is being processed. For example, press [Exit], and then press the [Home] key. Next, press the [Copier] icon on the [Home] screen, and then press the [Stop] key. When the message appears on the screen, follow the instructions to cancel the job.
"Output buffer is full. Sending the data has been cancelled. Please try again later."	Too many jobs are in standby state, and sending was canceled.	Retry sending after sending jobs in standby state completes.
"SMTP authentication email address and administrator email address mismatch."	The SMTP authentication e-mail address and the administrator's e-mail address do not match.	For details about how to set SMTP authentication, see "File Transfer", Connecting the Machine/ System Settings  .





Message	Causes	Solutions
"Scanner journal full. Cannot send data. Delete scan.journals in Scan.Features."	"Print & Delete Scanner Journal" in [Scanner Features] is set to [Do not Print: Disable Send], and Scanner Journal is full.	Print or delete Scanner Journal. For details about printing or deleting Scanner Journal, see "General Settings", Scan  .
"Selected file is currently in use. File name cannot be changed."	You cannot change the name of a file whose status is "Waiting to send data..." or that is being edited with DeskTopBinder.	Cancel transmission ("Waiting to send data..." status cleared) or the DeskTopBinder setting, and then change the file name.
"Selected file is currently in use. Password cannot be changed."	You cannot change the password of a file whose status is "Waiting to send data..." or that is being edited with DeskTopBinder.	Cancel transmission ("Waiting to send data..." status cleared) or the DeskTopBinder setting, and then change the password.
"Selected file is currently in use. User name cannot be changed."	You cannot change the sender's name whose status is "Waiting to send data..." or that is being edited with DeskTopBinder.	Cancel transmission ("Waiting to send data..." status cleared) or the DeskTopBinder setting, and then change the user name.
"Some destinations cannot receive encrypted files. Sending to these destinations may be unsafe."	If you have selected multiple destinations including destinations for which encryption has not been configured, e-mail sent to those destinations will not be encrypted even if you specify encryption.	Using Web Image Monitor, check the file encryption settings for all destinations.
"Some destinations will receive automatically encrypted files. All files sent to these destinations will be encrypted."	If you have selected multiple destinations including destinations for which encryption has been configured, e-mail sent to such destinations will be automatically encrypted.	Using Web Image Monitor, check the file encryption settings for all destinations.





Message	Causes	Solutions
"Some invalid destination(s) contained. Do you want to select only valid destination(s)?"	The specified group contains e-mail destinations and Scan to Folder destinations, either of which are incompatible with the specified transmission method.	In the message that appears at each transmission, press [Select].
"Some of selected files are currently in use. They could not be deleted."	You cannot delete a file which is waiting to be transmitted ("Waiting to send data..." status displayed) or whose information is being changed with DeskTopBinder.	Cancel transmission ("Waiting to send data..." status cleared) or the DeskTopBinder setting, and then delete the file.
"Some page(s) are almost blank. To cancel press the Stop key."	The first page of the document is almost blank.	The original's blank side might have been scanned. Be sure to place your originals correctly.
"The entered file name contains invalid character(s). Enter the file name again using any of the following 1 byte characters. " 0 to 9 ", " A to Z ", " a to z ", " . - _ ""	The file name contains a character that cannot be used.	<ul style="list-style-type: none"> • Check the file name specified at the time of scanning. For details about characters that can be used in file names, see "Available Characters and How to Enter Them", Getting Started . • Check the file name specified at the time of scanning. The file name specified in the Sending Scan Files to Folders function cannot contain the following characters: $\backslash / : * ? " < >$ The file name cannot start or end with a period ".".
"The number of destinations that can be entered manually at the same time is as shown above."	The e-mail has too many destinations.	Split the destinations into two or more groups.

Message	Causes	Solutions
"The number of destinations that can be specified at the same time is as shown above."	The e-mail has too many destinations.	Split the destinations into two or more groups.
"The selected file(s) contained file(s) without access privileges. Only file(s) with access privileges will be deleted."	You have tried to delete files without the authority to do so.	To check your access permission for stored documents, or to delete a document you do not have permission to delete, see Security Guide  .
"Transmission has failed. Insufficient memory in the destination hard disk. To check the current status, press [Comm. Status/Print]."	Transmission has failed. There was not enough free space on the hard disk of the SMTP server, FTP server, or client computer at the destination.	Allocate sufficient space.
"Transmission has failed. To check the current status, press [Comm. Status/Print]."	While a file was being sent, a network error occurred and the file could not be sent correctly.	If the same message appears again after scanning again, the cause could be a mixed network, or else network settings were changed during WSD scanner transmission. For details about network error, contact your administrator.

Message	Causes	Solutions
"Updating the destination list has failed. Try again?"	A network error has occurred.	<ul style="list-style-type: none"> • Check whether the server is connected. • Antivirus programs and firewalls can prevent client computers from establishing connection with this machine. <ul style="list-style-type: none"> • If you are using anti-virus software, add the program to the exclusion list in the application settings. For details about how to add programs to the exclusion list, see the anti-virus software Help. • To prevent a firewall blocking the connection, register the machine's IP address in the firewall's IP address exclusion settings. For details about the procedure for excluding an IP address, see your firewall's Help.
"Updating the destination list... Please wait. Specified destination(s) or sender's name has been cleared."	A specified destination or sender's name was cleared when the destination list in the delivery server was updated.	Specify the destination or sender's name again.
"Updating the destination list... Please wait. Specified destination(s) or sender's name has been cleared."	The destination list is being updated from the network using Web Image Monitor.	Wait until the message disappears. Do not turn off the main power switch while this message is displayed. Depending on the number of destinations to be updated, there may be some delay before you can resume operation. Operations are not possible while this message is displayed.

Message	Causes	Solutions
"You do not have the privileges to use this function."	The logged in user name does not have permission for the selected function.	For details about how to set permissions, see Security Guide  .
"Exceeded max. data capacity. Check the resolution and the ratio and then press the Start key again."	The data being scanned is too large for the scale ratio specified in [Specify Size].	Reduce the resolution or [Specify Size] value, and then try to scan the original again.
"The size of the scanned data is too small. Check the scanning resolution, then press the Start key again."	The data being scanned is too small for the scale ratio specified in [Specify Size].	Specify a higher resolution or a large size in [Specify Size], and then try to scan the original again.
"Not all of the image will be scanned."	If the scaling factor specified in "Reproduction Ratio" is too large, part of the image may be lost.	<ul style="list-style-type: none"> • Reduce the scaling factor in "Reproduction Ratio", and then try to scan the original again. • If displaying the entire image is not necessary, press the [Start] key to start scanning with the current scaling factor.
"Not all of the image will be scanned."	Using "Reproduction Ratio" to scale down a large document may cause part of the image to be lost.	<ul style="list-style-type: none"> • Specify a large size in [Specify Size], and then try to scan the original again. • If displaying the entire image is not necessary, press the [Start] key to start scanning with the current scaling factor.
"Check original's orientation."	Documents may sometimes not be scanned depending on a combination of items such as the specified scaling factor and document size.	Change the orientation of the original, and then try to scan the original again.
"The Digital Signature's device certificate has expired. The file cannot be sent."	The device certificate (PDF with digital signature) has expired.	A new device certificate (PDF with digital signature) must be installed. For details about how to install a device certificate (PDF with digital signature), see Security Guide  .



Message	Causes	Solutions
"XXX cannot be YYY because the Digital Signature's device certificate is not currently valid." (XXX and YYY indicate the user action.)	The device certificate (PDF with digital signature) has expired.	A new device certificate (PDF with digital signature) must be installed. For details about how to install a device certificate (PDF with digital signature), see Security Guide  .
"The Digital Signature's device certificate is invalid. The file cannot be sent."	There is no device certificate (PDF with digital signature), or the certificate is invalid.	A new device certificate (PDF with digital signature) must be installed. For details about how to install a device certificate (PDF with digital signature), see Security Guide  .
"XXX cannot be YYY because there is a problem with the Digital Signature's device certificate. Check the device certificate." (XXX and YYY indicate the user action.)	There is no device certificate (PDF with digital signature), or the certificate is invalid.	A new device certificate (PDF with digital signature) must be installed. For details about how to install a device certificate (PDF with digital signature), see Security Guide  .
"XXX cannot be YYY because there is a problem with the device certificate used for the S/MIME signature. Check the device certificate." (XXX and YYY indicate the user action.)	There is no device certificate (S/MIME), or the certificate is invalid.	A new device certificate (S/MIME) must be installed. For details about how to install a device certificate (S/MIME), see Security Guide  .
"XXX cannot be YYY because the device certificate used for the S/MIME signature is not currently valid." (XXX and YYY indicate the user action.)	The device certificate (S/MIME) has expired.	A new device certificate (S/MIME) must be installed. For details about how to install a device certificate (S/MIME), see Security Guide  .



Message	Causes	Solutions
"Transmission cannot be performed because the certificate used for the S/MIME signature is not currently valid."	The device certificate (S/MIME) has expired.	A new device certificate (S/MIME) must be installed. For details about how to install a device certificate (S/MIME), see Security Guide  .
"The destination cannot be selected because its certificate is not currently valid."	The user certificate (destination certificate) has expired.	A new user certificate must be installed. For details about the user certificate (destination certificate), see Security Guide  .
"The group destination cannot be selected because it contains a destination with a certificate that is not currently valid."	The user certificate (destination certificate) has expired.	A new user certificate must be installed. For details about the user certificate (destination certificate), see Security Guide  .
"Transmission cannot be performed because the certificate for encryption is not currently valid."	The user certificate (destination certificate) has expired.	A new user certificate must be installed. For details about the user certificate (destination certificate), see Security Guide  .

When Messages Are Displayed on Your Computer Screen



Messages Displayed When Using the Scanner Function

This section describes likely causes of and possible solutions for the main error messages displayed on the client computer when using the TWAIN driver. If a message not described here appears, act according to the message.

Message	Causes	Solutions
"Any of Login User Name, Login Password or Driver Encryption Key is incorrect."	The entered Login User Name, Login Password, or DriverEncryp.Key was invalid.	Check your Login User Name, Login Password, or DriverEncryp.Key, and then enter them correctly. For details about Login User Name, Login Password, and DriverEncryp.Key, see Security Guide  .
"Authentication succeeded. However, the access privileges for scanner function has been denied."	The logged in user name does not have permission for scanner function.	For details about how to set permissions, see Security Guide  .
"Call Service" "Please call your service representative."	An unrecoverable error has occurred in the machine.	Contact your service representative.
"Cannot add any more scanning mode."	The maximum number of registerable scan modes has been exceeded.	The maximum number of modes that can be stored is 100. Delete unneeded modes.
"Cannot connect to the scanner. Check the network Access Mask settings in User Tools."	An access mask is set.	For details about an access mask, contact your administrator.
"Cannot find "XXX" scanner used for the previous scan. "YYY" will be used instead." ("XXX" and "YYY" indicate scanner names.)	The main power switch of the previously used scanner is not set to "On".	Check whether the main power switch of the scanner used for the previous scan is turned on.

Message	Causes	Solutions
"Cannot find "XXX" scanner used for the previous scan. "YYY" will be used instead." ("XXX" and "YYY" indicate scanner names.)	The machine is not connected to the network correctly.	<ul style="list-style-type: none"> • Check that the previously used scanner is connected to the network correctly. • Cancel the personal firewall of the client computer. For details about firewall, see Windows Help. • Use an application such as telnet to make sure SNMPv1 or SNMPv2 is set as the machine's protocol. For details about how to check this, see "Remote Maintenance Using telnet", Connecting the Machine/ System Settings . • Select the scanner used for the previous scan.
"Cannot specify any more scanning area."	The maximum number of registerable scan areas has been exceeded.	The maximum number of scanning areas that can be stored is 100. Delete unneeded scanning areas.
"Clear Misfeed(s) in ADF."	A paper misfeed has occurred inside the ADF.	<ul style="list-style-type: none"> • Remove jammed originals, and then insert them again. For details about how to remove jammed paper, see "Removing Jammed Paper", Troubleshooting . • When a misfeed occurs, replace the jammed originals. • Check whether the originals are suitable to be scanned by the machine.
"Communication error has occurred on the network."	A communication error has occurred on the network.	Check whether the client computer can use the TCP/IP protocol.

Message	Causes	Solutions
"Error has occurred in the scanner driver."	An error has occurred in the driver.	<ul style="list-style-type: none"> • Check whether the network cable is connected correctly to the client computer. • Check whether the Ethernet board of the client computer is recognized correctly by Windows. • Check whether the client computer can use the TCP/IP protocol.
"Error has occurred in the scanner."	The application-specified scan conditions have exceeded the setting range of the machine.	Check whether the scanning settings made with the application exceed the setting range of the machine.
"Fatal error has occurred in the scanner."	An unrecoverable error has occurred on the machine.	An unrecoverable error has occurred in the machine. Contact your service representative.
"Insufficient memory. Close all other applications, then restart scanning."	Memory is insufficient.	<ul style="list-style-type: none"> • Close all the unnecessary applications running on the client computer. • Uninstall the TWAIN driver, and then reinstall it after restarting the computer.

Message	Causes	Solutions
"Insufficient memory. Reduce the scanning area."	Scanner memory is insufficient.	<ul style="list-style-type: none"> • Reset the scan size. • Lower the resolution. • Set with no compression. For details about the settings, see TWAIN driver Help. <p>The problem may also be due to the following causes:</p> <ul style="list-style-type: none"> • Scanning cannot be performed if large values are set for brightness when using halftone or high resolution. For details about the relationship between scan settings, see "Relationship between Resolution and Scan Size", Scan . • If a misfeed occurs, you might not scan an original. Remove the misfeed, and then scan the original again.
"Invalid Winsock version. Please use version 1.1 or higher."	You are using an invalid version of Winsock.	Install the operating system of the computer or copy Winsock from the operating system CD-ROM.
"No User Code is registered. Consult your system administrator."	Access is restricted with user codes.	For details about User Code Authentication, see Security Guide  .
"No response from the scanner."	The machine or client computer is not connected to the network correctly.	<ul style="list-style-type: none"> • Check whether the machine or client computer is connected to the network correctly. • Disable the client computer's own firewall. For details about firewall, see Windows Help.
"No response from the scanner."	The network is crowded.	Wait for a while, and then try to reconnect.

Message	Causes	Solutions
"Scanner is in use for other function. Please wait."	A function of the machine other than the Scanner function is being used such as the Copier function.	<ul style="list-style-type: none"> • Wait for a while, and then reconnect. • Cancel the job that is being processed. For example, press [Exit], and then press the [Home] key. Next, press the [Copier] icon on the [Home] screen, and then press the [Stop] key. When the message appears on the screen, follow the instructions to cancel the job.
"Scanner is not available on the specified device."	The TWAIN scanner function cannot be used on this machine.	Contact your service representative.
"Scanner is not available. Check the scanner connection status."	The machine's main power switch is off.	Turn on the main power switch.
"Scanner is not available. Check the scanner connection status."	The machine is not connected to the network correctly.	<ul style="list-style-type: none"> • Check whether the machine is connected to the network correctly. • Deselect the personal firewall function of the client computer. For details about firewall, see Windows Help. • Use an application such as telnet to make sure SNMPv1 or SNMPv2 is set as the machine's protocol. For details about how to check this, see "Remote Maintenance Using telnet", Connecting the Machine/ System Settings .

Message	Causes	Solutions
<p>"Scanner is not available. Check the scanner connection status."</p>	<p>Network communication is not available because the machine's IP address could not be obtained from the host name. If only "IPv6" is set to [Active], the IPv6 address might not be obtained.</p>	<ul style="list-style-type: none"> • Check whether the machine's host name is specified in the Network Connection Tool. For the WIA driver, check the [Network Connection] tab in the properties. • Use Web Image Monitor to set "LLMNR" of "IPv6" to [Active]. • In Windows XP, IPv6 addresses cannot be obtained from the host name. Specify the machine's IPv6 address in the Network Connection Tool.
<p>"Scanner is not ready. Check the scanner and the options."</p>	<p>The ADF cover is open.</p>	<p>Check whether the ADF cover is closed.</p>
<p>"The name is already in use. Check the registered names."</p>	<p>You tried to register a name that is already in use.</p>	<p>Use another name.</p>

11. Appendix

This chapter describes the trademarks.

Trademarks

Adobe, Acrobat, PostScript, PostScript 3, and Reader are either registered trademarks or trademarks of Adobe Systems Incorporated in the United States and/or other countries.

The Bluetooth[®] word mark and logos are registered trademarks owned by Bluetooth SIG, Inc. and any use of such marks by Ricoh Company, Ltd. is under license.

Microsoft, Windows, Windows Server, and Windows Vista are either registered trademarks or trademarks of Microsoft Corp. in the United States and/or other countries.

The SD is a trademark of SD-3C, LLC.

UNIX is a registered trademark of The Open Group.

The proper names of the Windows operating systems are as follows:

- The product names of Windows XP are as follows:
 - Microsoft[®] Windows[®] XP Professional
 - Microsoft[®] Windows[®] XP Home Edition
 - Microsoft[®] Windows[®] XP Media Center Edition
 - Microsoft[®] Windows[®] XP Tablet PC Edition
- The product names of Windows Vista are as follows:
 - Microsoft[®] Windows Vista[®] Ultimate
 - Microsoft[®] Windows Vista[®] Business
 - Microsoft[®] Windows Vista[®] Home Premium
 - Microsoft[®] Windows Vista[®] Home Basic
 - Microsoft[®] Windows Vista[®] Enterprise
- The product names of Windows 7 are as follows:
 - Microsoft[®] Windows[®] 7 Home Premium
 - Microsoft[®] Windows[®] 7 Professional
 - Microsoft[®] Windows[®] 7 Ultimate
 - Microsoft[®] Windows[®] 7 Enterprise
- The product names of Windows Server 2003 are as follows:
 - Microsoft[®] Windows Server[®] 2003 Standard Edition
 - Microsoft[®] Windows Server[®] 2003 Enterprise Edition
- The product names of Windows Server 2003 R2 are as follows:

Microsoft® Windows Server® 2003 R2 Standard Edition

Microsoft® Windows Server® 2003 R2 Enterprise Edition

- The product names of Windows Server 2008 are as follows:

Microsoft® Windows Server® 2008 Standard

Microsoft® Windows Server® 2008 Enterprise

- The product names of Windows Server 2008 R2 are as follows:

Microsoft® Windows Server® 2008 R2 Standard

Microsoft® Windows Server® 2008 R2 Enterprise

Other product names used herein are for identification purposes only and might be trademarks of their respective companies. We disclaim any and all rights to those marks.

INDEX

2 Sided Print.....9

A

Address book 11, 75, 76, 102, 104, 105, 108, 109
ADF.....8, 25, 28, 31, 33, 54
Authentication screen.....50
Auto Document Feeder.....8, 25, 28, 31, 33, 54
Auto Reduce/Enlarge..... 14, 57

B

Beep alert.....148
Bypass tray.....26, 29, 32, 67, 127

C

Canceling a transmission.....80, 81
Check Status key.....37, 146
Check Status screen.....146
Checking a stored file.....112
Clear key.....36
Combine.....9, 14, 62
Communicating indicator.....36
Confidential File indicator.....36
Control panel.....25, 28, 31, 35
Converting documents to electronic formats.....10
Copier.....55
Copy Data Security unit.....24
Copy orientation.....61
Counter key.....36
Creating a shared folder.....100
Custom size paper.....67, 130

D

Data In indicator.....37
Display panel.....35
Document Server.....10, 16, 72, 84, 85, 115, 117
Duplex.....14, 59
Duplex Copy.....9, 59

E

E-mail address.....108, 109, 110
E-mail destination.....108, 109, 110
Energy Saver key.....36
Enter key.....36

Envelope.....68, 139
Error message. 154, 156, 169, 170, 174, 182, 197
Exposure glass.....26, 29, 32, 52, 53
Exposure glass cover.....25, 33
Extender.....25, 26, 28, 29, 31, 32
External options.....33, 34

F

Fax destination.....75, 76
Fax Received indicator.....36
File type.....113
Folder destination.....102, 104, 105
Front cover.....26, 28, 31
Function keys.....35

H

Handset.....34
Hold Print.....15, 94
Home key.....35
Home screen.....13, 38, 39
How to Read the Manuals.....6

I

Icon.....38, 39, 40
Immediate Transmission.....78, 79
Indicator.....145
Information screen.....9
Installing the printer driver.....89
Internal tray.....25, 28, 31
Internal tray guide.....26, 28, 31
Internet Fax.....19
IP-Fax.....19

J

Journal.....87

L

LAN-Fax.....9, 17
Loading orientation-fixed paper.....132
Loading paper.....123, 124, 127
Loading two-sided paper.....132
Locked Print.....15, 92
Logging in to the machine.....50
Logging out the machine.....51
Login key.....36

Login/Logout key.....	36
Logout key.....	36
Lower right cover.....	27, 29, 32

M

Main power indicator.....	36
Main power switch.....	26, 28, 31, 48
Media access lamp.....	37
Media slots.....	37
Memory.....	156, 169
Memory Transmission.....	73, 74
Message. 149, 154, 156, 169, 170, 174, 182, 197	
Model-specific information.....	7

N

Names of major features.....	8
Number keys.....	36

O

OHP transparency.....	130
One-Sided Combine.....	63
Options.....	33
Orientation-fixed paper.....	132

P

Paper capacity.....	135
Paper guide.....	26, 29, 32
Paper size.....	129, 135
Paper thickness.....	135
Paper tray.....	26, 28, 31, 123
Paper tray unit.....	26, 28, 31, 33, 34
Paper type.....	135
Paper weight.....	135
Paperless Fax.....	9, 17
Placing originals.....	52, 53, 54
Preventing information leakage.....	22
Printer.....	91
Printer Bypass Paper Size.....	129, 130
Printer driver properties.....	90
Problem.....	149
Program.....	12, 44, 46
Program as Defaults.....	12
Program key.....	35

Q

Quick install.....	89
--------------------	----

R

Region A.....	7
Region B.....	7
Registering destinations.....	11
Reset key.....	35
Right cover.....	26, 29, 32
Running out of toner.....	143

S

Sample Print.....	15
Saving paper.....	9
Scan to E-mail.....	21, 107
Scan to Folder.....	21, 99
Security functions.....	22
Send Later.....	83
Send Settings.....	114
Sending stored documents.....	85
Shared folder.....	100
Shortcut icon.....	12, 38, 39, 40
Simple Screen key.....	36
SMB folder.....	102, 104, 105
Sort.....	14, 70
Standard printing.....	91
Start key.....	36
Status message.....	169
Stop key.....	36
Stored Print.....	15, 96, 97
Storing a document.....	84
Storing data.....	72
Storing received documents.....	17
Storing scan files.....	111
Symbols.....	6

T

Thick paper.....	130, 138
Toner.....	142, 143, 144
Trademark.....	203
Tray 1.....	123
Tray 2.....	26, 28, 31, 33, 34, 124
Tray 3.....	26, 28, 31, 33, 34, 124
Turning off the power.....	48

Turning on the power.....	48
Two-Sided Combine.....	64
Two-sided paper.....	132

U

Unauthorized copy prevention.....	24
Used toner.....	144
User code authentication.....	50
User Tools key.....	36
User Tools/Counter key.....	36

V

Ventilation holes.....	26, 27, 28, 30, 31, 32
------------------------	------------------------

W

Web Image Monitor.....	23, 119, 121
------------------------	--------------

MEMO

