



User Guide

Getting Started	1
Loading Paper	2
Troubleshooting	3
Information for This Printer	4



For safe and correct use, be sure to read the Safety Information in Read This First before using the machine.

TABLE OF CONTENTS

Manuals for This Machine.....	4
-------------------------------	---

1. Getting Started

Before You Start.....	7
How to Read the Manuals.....	7
Model-Specific Information.....	8
List of Options.....	9
Guide to Names and Functions of Components.....	11
Guide to Functions of the Attention Light.....	13
Guide to Functions of the Machine's Options.....	16
Guide to Functions of the Machine's External Options.....	16
Guide to Functions of the Machine's Internal Options.....	17
Guide to the Names and Functions of the Machine's Control Panel.....	19
Changing the Display Language.....	20
How to Use the [Home] Screen.....	21
Main Icons on the [Home] Screen.....	23
[Printer (Classic)] Screen.....	24
[Information] Screen.....	25
Possible Operations on the Screen.....	26
Adding Icons to the [Home] Screen.....	28
Turning On/Off the Power.....	30
Turning On/Off the Power.....	30
Saving Energy.....	31
Accessing User Tools.....	33
Changing Default Settings.....	33
Quitting User Tools.....	34
Using Web Image Monitor.....	35
Displaying Top Page.....	36
Replenishing and Replacing Consumables.....	38
Adding Toner.....	38
Adding Staples.....	40
Replacing Other Consumables.....	40

2. Loading Paper

Loading Paper.....	43
--------------------	----





Precautions for Loading Paper.....	43
Loading Paper into Paper Trays.....	43
Loading Paper into the Bypass Tray.....	45
Loading Paper into Tray 3 (LCT).....	46
Loading Paper into the Large Capacity Tray (LCT).....	48
Loading Orientation-fixed Paper or Two-sided Paper.....	49
Recommended Paper.....	51
Recommended Paper Sizes and Types.....	51
Printing from the Bypass Tray.....	61
Specifying Regular Sizes Using the Control Panel.....	61
Specifying a Custom Size Paper Using the Control Panel.....	61
Specifying Thick Paper, Thin Paper, or OHP Transparencies for Paper Type Using the Control Panel....	62

3. Troubleshooting

When the Machine Makes a Beeping Sound.....	65
When a Status Icon Is Displayed.....	66
When the Indicator Lamp for [Check Status] Is Lit or Flashing.....	67
When You Have Problems Operating the Machine.....	69
If USB Connection Fails.....	73
Messages Displayed When You Use the Printer Function.....	74
Messages Displayed on the Control Panel When You Use the Printer Function.....	74
Messages Printed on the Error Logs or Reports When You Use the Printer Function.....	77
When Other Messages Appear.....	79
When Problems Occur While Logging In.....	80
When the User Lacks Privileges to Perform an Operation.....	80
When You Cannot Print.....	81
Other Printing Problems.....	83
Removing Jammed Paper.....	92
Locating Jammed Paper.....	92

4. Information for This Printer

Information on Environmental Regulations.....	95
ENERGY STAR Program.....	95
Energy Saving Functions.....	95

User Information on Electrical and Electronic Equipment  Region A (mainly Europe).....	97
Note for the Battery and/or Accumulator Symbol (For EU countries only)  Region A (mainly Europe)	98
Environmental Advice for Users  Region A (mainly Europe).....	98
Notes to users in the state of California (Notes to Users in USA)  Region B (mainly North America)....	99
Trademarks.....	100
INDEX	103

Manuals for This Machine

The operating instructions of this machine are provided in the following formats:

Format	Manuals
Printed manuals	<ul style="list-style-type: none">• Read This First• Start Guide• Quick Installation Guide
CD-ROM	<ul style="list-style-type: none">• Driver Installation Guide
Web page	<ul style="list-style-type: none">• Read This First• User Guide• Operating Instructions (HTML manuals)• Start Guide• Quick Installation Guide• Driver Installation Guide

Read This First

Before using the machine, be sure to read the section of this manual entitled Safety Information. It also describes each regulation and environmental conformance.

Start Guide

Describes how to read manuals on the control panel. It also describes how to log in to the machine.

User Guide

Regarding the basic usage of this machine, frequently used functions, troubleshooting when an error message appears, etc., summaries are provided for each user manual.

Operating Instructions (HTML manuals)

Describes the setup for using the machine, how to use functions to print or for maintenance and specifications, troubleshooting, system settings, and security functions.

Manuals are available in English, German, French, Italian, Spanish, Dutch, and Russian.

User Guide and Security Guide are available in the seven languages above and other languages.

For details about how to use the HTML manuals, see "How to Use the Operating Instructions", Operating Instructions.

Quick Installation Guide

Describes procedures for unpacking and setting up the machine, which include loading paper and installing print cartridge, etc.

Driver Installation Guide

Describes how to install and configure each driver. This manual is included in the drivers CD.

Note

- Before you configure the extended security and authentication settings, refer to "Before Using This Machine" in the Security Guide.
- You can see the following manuals on the Web page.
 - Appendix
 - DHCP Option 204



1. Getting Started

This section describes the symbols used in the manuals supplied with the printer, available options, and names and functions of components.

Before You Start

How to Read the Manuals

Symbols used in the manuals

This manual uses the following symbols:

 **Important**

Indicates points to pay attention to when using the machine, and explanations of likely causes of paper misfeeds, damage to originals, or loss of data. Be sure to read these explanations.

 **Note**

Indicates supplementary explanations of the machine's functions, and instructions on resolving user errors.

[]

Indicates the names of keys on the machine's display or control panels.

 **Region A** (mainly Europe and Asia), (mainly Europe), or (mainly Asia)

 **Region B** (mainly North America)

Differences in the functions of Region A and Region B models are indicated by the two symbols. Read the information indicated by the symbol that corresponds to the region of the model you are using. For details about which symbol corresponds to the model you are using, see page 8 "Model-Specific Information".

Disclaimer

Contents of this manual are subject to change without prior notice.

In no event will the company be liable for direct, indirect, special, incidental, or consequential damages as a result of handling or operating the machine.

Notes

The manufacturer shall not be responsible for any damage or expense that might result from the use of parts other than genuine parts from the manufacturer with your office products.

For good output quality, the manufacturer recommends that you use genuine toner from the manufacturer.

Some illustrations in this manual might be slightly different from the machine.

About IP addresses

In this manual, "IP address" covers both IPv4 and IPv6 environments. Read the instructions that are relevant to the environment you are using.

Model-Specific Information

This section explains how to identify the region to which your printer belongs.

There is a label on the rear of the printer, located in the position shown below. The label contains details that identify the region to which your printer belongs. Read the label.

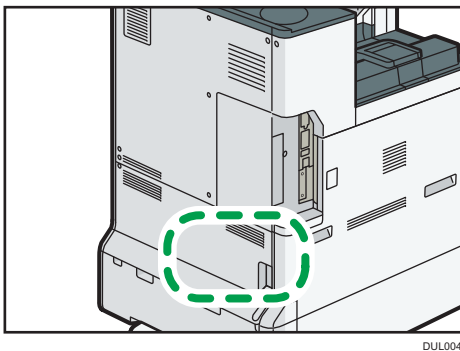

The following information is region-specific. Read the information under the symbol that corresponds to the region of your printer.

 **Region A** (mainly Europe and Asia)

If the label contains the following, your printer is a Region A model:

- CODE XXXX -27
- 220–240 V

 **Region B** (mainly North America)

If the label contains the following, your printer is a Region B model:

- CODE XXXX -17
- 120–127 V

 **Note**

- Dimensions in this manual are given in two measurement units: metric and imperial. If your printer is a Region A model, refer to the metric units. If your printer is a Region B model, refer to the imperial units.

List of Options

This section provides a list of options for this printer and the names commonly used in this manual.

Option name	Description
Paper Feed Unit PB3240	Lower Paper Trays
LCIT PB3260	Tray 3 (LCT)
LCIT RT3030	Large Capacity Tray (LCT)
Mail Box CS3010	Mailbox
Internal Multi-fold Unit FD3000	Internal Multi-Folding unit
Bridge Unit BU3070	Bridge unit
Punch Unit PU3050 EU Punch Unit PU3050 NA Punch Unit PU3050 SC Punch Unit PU3060 EU Punch Unit PU3060 NA Punch Unit PU3060 SC	Punch unit
Output Jogger Unit Type M25	Output jogger unit
Attention Light AL3000	Attention Light
HDD Option Type P13	HDD
IPDS Unit Type P13	IPDS unit
XPS Direct Print Option Type P13	XPS card
IEEE 802.11a/g/n Interface Unit Type M19	Wireless LAN board
IEEE 1284 Interface Board Type M19	IEEE 1284 Interface Board
USB Device Server Option Type M19	USB Device Server

Option name	Description
Extended USB Board Type M19	Extended USB Board
VM CARD Type P13	VM card
PostScript3 Unit Type P13	Adobe PostScript 3 unit

Guide to Names and Functions of Components

⚠ CAUTION

- Do not obstruct the machine's vents. Doing so risks fire caused by overheated internal components.

Front and left view

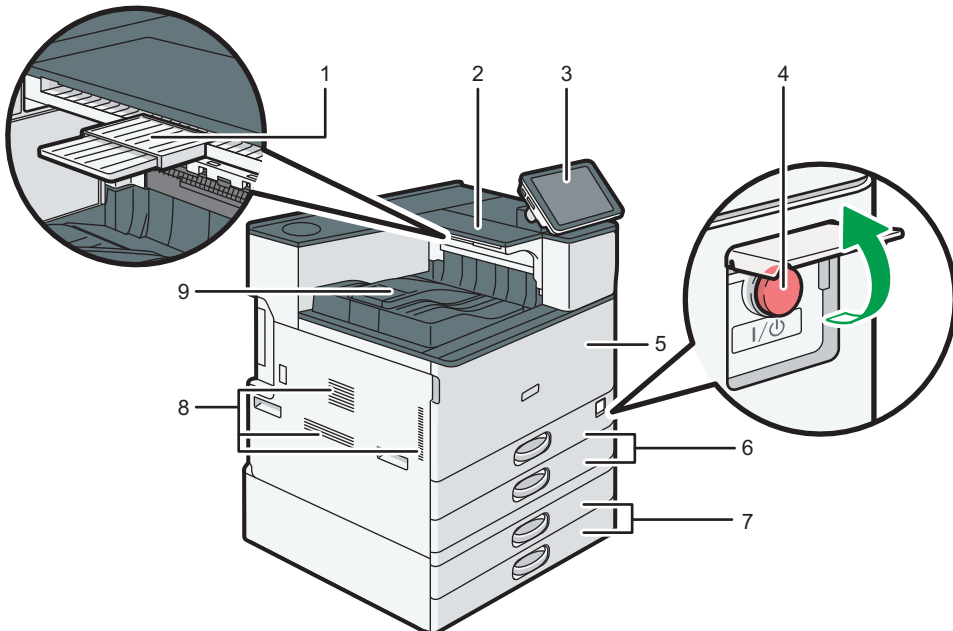

DUL005

1. Auxiliary Tray on the Paper Reversal Location

Pull this tray to print on paper larger than A4 or $8\frac{1}{2} \times 11$.

2. Paper Reversal Location

This area is used to reverse pages that are printed on both sides.

3. Control panel

See page 19 "Guide to the Names and Functions of the Machine's Control Panel".

4. Main power switch

To operate the machine, the main power switch must be on. If it is off, open the main power switch's cover and turn the switch on.

5. Front cover

Open to access the inside of the machine.

6. Paper trays (Trays 1–2)

Load paper here. For details, see page 43 "Loading Paper".

7. Lower paper trays

Load paper here. For details, see page 43 "Loading Paper".

8. Vents

Prevent overheating.

9. Internal tray 1

Printed paper are delivered here.

Front and right view

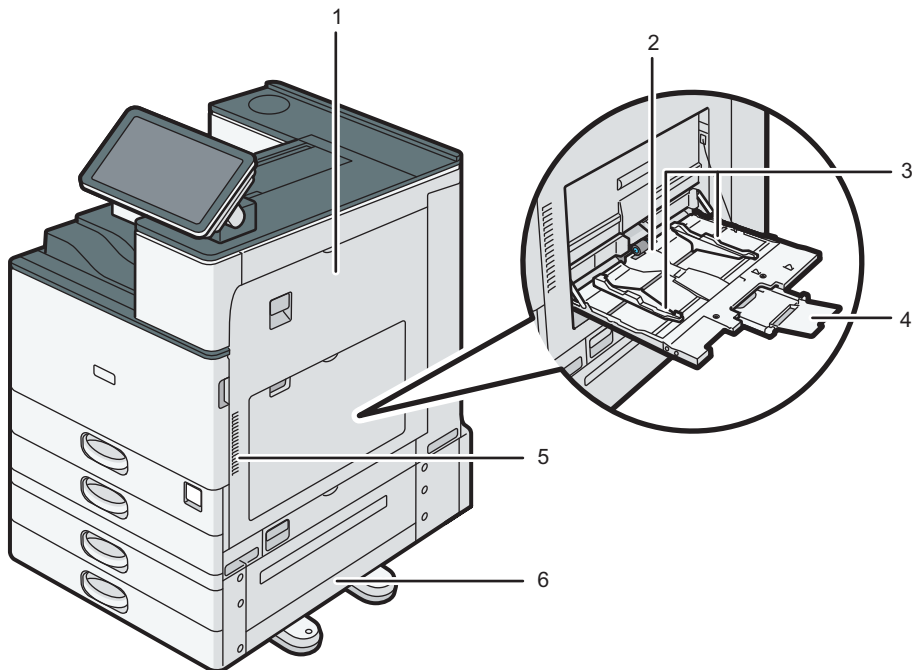

DUL006

1. Right cover

Open this cover when a paper jam occurs.

2. Bypass tray

Use to print on OHP transparencies, adhesive labels, and paper that cannot be loaded in the paper trays. For details, see page 45 "Loading Paper into the Bypass Tray".

3. Paper guides

When loading paper in the bypass tray, align the paper guides flush against the paper.

4. Extender

Pull this extender out when loading sheets larger than A4, 8¹/₂ × 11 in in the bypass tray.

5. Vents

Prevent overheating.

6. Lower right cover

Open this cover when a paper jam occurs.

Rear and left view

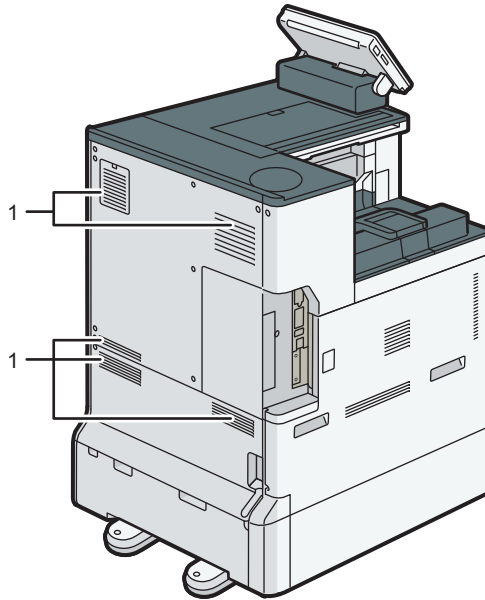

DUL007

1. Vents

Prevent overheating.

Guide to Functions of the Attention Light

This section introduces functions of the attention light.

⚠ CAUTION

- Do not push or pull the attention light when installed to the machine. Doing so may result in damage or malfunction of the attention light or the machine.

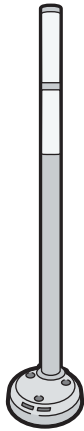

CUV121

The attention light notifies the user by light when there is a paper jam or no paper is left.

The colors of the lamp and their meanings are as follows:

Lamp	Status
The bottom lamp lights blue.	Printing
The bottom lamp flashes blue.	Data in
The top lamp lights red.	<p>Error occurred (Example)</p> <ul style="list-style-type: none"> • When the service call message appears • Paper jam • Out of paper • Out of toner • Memory overflow <p>Read the message on the display panel, and then take appropriate action. For details, see "When Messages Appear and the Machine Cannot Be Operated", Operating Instructions, page 74 "Messages Displayed When You Use the Printer Function", or page 79 "When Other Messages Appear".</p>

Lamp	Status
<p>The top lamp flashes yellow.</p>	<p>Warning (Example)</p> <ul style="list-style-type: none"> • Toner has nearly run out. • Waste toner bottle is nearly full. • Paper has nearly run out. <p>Read the message on the display panel, and then take appropriate action. For details, see "When Messages Appear and the Machine Cannot Be Operated", Operating Instructions, page 74 "Messages Displayed When You Use the Printer Function", or page 79 "When Other Messages Appear".</p>

Guide to Functions of the Machine's Options

1 Guide to Functions of the Machine's External Options

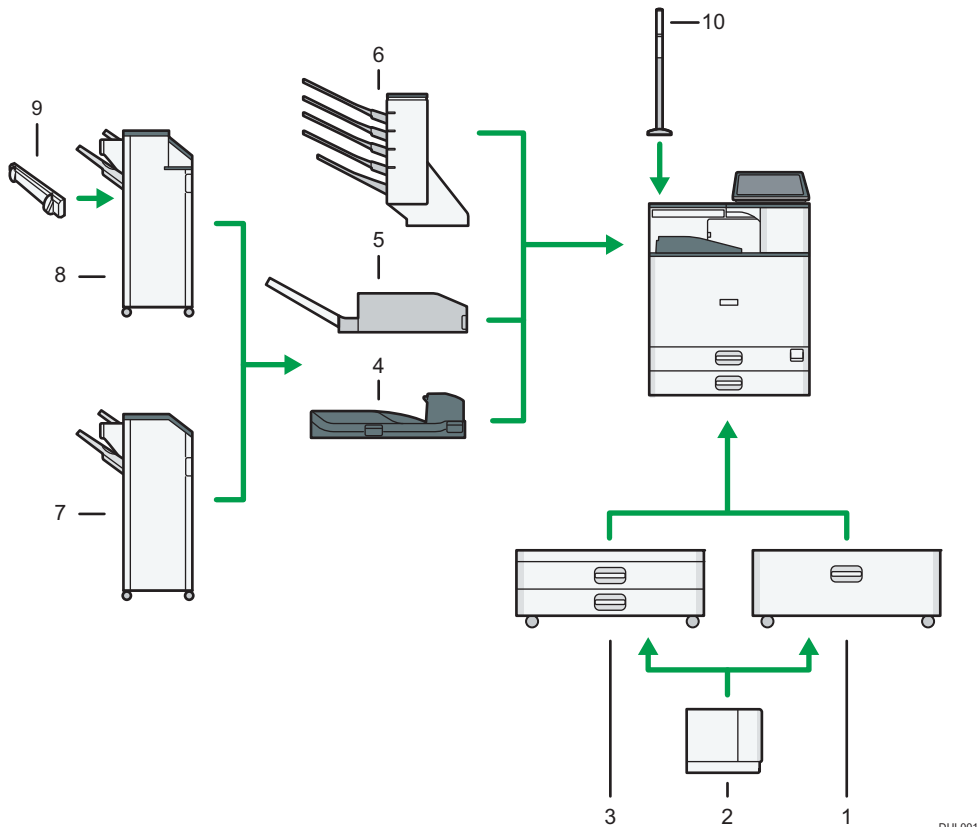

DUL001

1. Tray 3 (LCT)

Consists of two paper trays.

You can load paper even if Tray 3 (LCT) is in use. It is okay to pull out the left half of the tray while Tray 3 (LCT) is in use.

2. Large capacity tray (LCT)

Paper is loaded here.

3. Lower paper trays

Consists of two paper trays.

4. Bridge unit

Relays paper to the finisher.

5. Internal Multi-Folding unit

The Internal Multi-Folding unit can apply the following folds: Half Fold, Letter Fold-out, Letter Fold-in, and Z-fold.

6. Mailbox

Sorts printed paper. Consists of mailbox output trays 1–4.

7. Finisher SR3210

Sorts, stacks, and staples multiple sheets of paper. Consists of the following paper trays:

- Finisher upper tray
- Finisher shift tray

Copies can be punched if the optional punch unit is installed on the finisher.

8. Finisher SR3230

Sorts, stacks, and staples multiple sheets of paper. Consists of the following paper trays:

- Finisher upper tray
- Finisher shift tray

Copies can be punched if the optional punch unit is installed on the finisher.

9. Output jogger

Jogs the sheets delivered to the finisher shift tray.

10. Attention Light

The attention flashes or lights up to notify the user of printing errors such as a paper jam, or when no paper is left.

Guide to Functions of the Machine's Internal Options

- HDD
Allows you to store documents to be printed.
- Adobe PostScript 3 unit
Allows you to print by Adobe PostScript 3 printer driver.
If you remove the Adobe PostScript 3 Option from your machine, the PS/PDF function, which is a standard function, will no longer work.
- VM card
With this card, you can install embedded software applications.
- IPDS unit
Allows you to print using Intelligent Printer Data Stream (IPDS).
- XPS card
Allows you to print XPS files.
- USB device server

Allows you to add an Ethernet port to the printer and use two IP addresses at the same time.

To attach this option, see "Installing the Interface Units", Operating Instructions.

- Extended USB Board

Allows you to add a USB port.

To attach this option, see "Installing the Interface Units", Operating Instructions.

- IEEE 1284 interface board

Allows you to connect to an IEEE 1284 cable.

To attach this option, see "Installing the Interface Units", Operating Instructions.

- Wireless LAN board

Allows you to communicate over wireless LAN.

To attach this option, see "Installing the Interface Units", Operating Instructions.

Guide to the Names and Functions of the Machine's Control Panel

1

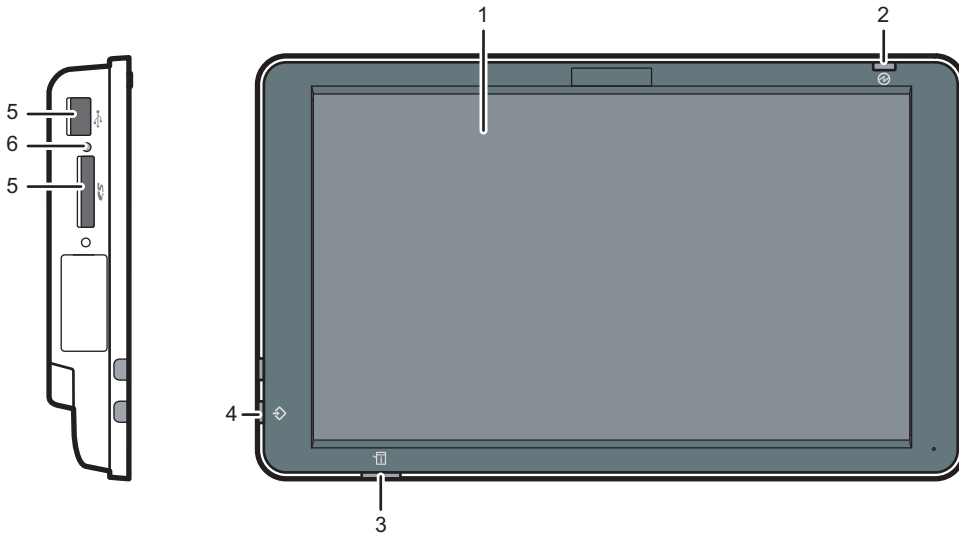

DNE093

1. Display panel

This is a touch panel display that features icons, keys, shortcuts, and widgets that allow you to navigate the screens of the various functions and applications and provide you with information about operation status and other messages. See page 21 "How to Use the [Home] Screen".

2. Main power indicator

The main power indicator goes on when you turn on the main power switch. When the machine is in Sleep mode, the main power indicator flashes slowly. In Fusing Unit Off mode, the main power indicator is lit.

3. Status indicator

Indicates the status of the system. Stays lit when an error occurs or the toner runs out.

4. Data In indicator (printer mode)

Flashes when the machine is receiving print jobs from a computer.

5. Media slots

Use to insert an SD card or a USB flash memory device. For details, see "Inserting/Removing a Memory Storage Device", Operating Instructions.

6. Media access lamp

Lights up when an SD card is inserted in the media slot.

Changing the Display Language

1

You can change the language used on the display. English is set as default.

1. Press [Home]  at the bottom of the screen in the center.
2. Flick the screen to the left, and then press the [Change Langs. Widget] icon.
3. Select the language you want to display.
4. Press [OK].

How to Use the [Home] Screen

The [Home] screen is set as the default screen when the machine is turned on.

One icon is assigned to each function, and these icons are displayed on the [Home] screen. You can add shortcuts to frequently used Web pages to the [Home] screen. Also, you can register widgets such as the Change Langs. Widget to it. The [Home] screen and the screen of each function may differ depending on the optional units that are installed.

To display the [Home] screen, press [Home] (🏠) at the bottom of the screen in the center.

★ Important

- Do not apply strong impact or force to the screen, or it may be damaged. Maximum force allowable is approx. 30N (approx. 3 kgf). (N = Newton, kgf = Kilogram force. 1 kgf = 9.8N.)

To switch between screens, flick your finger to the right or left on the screen.

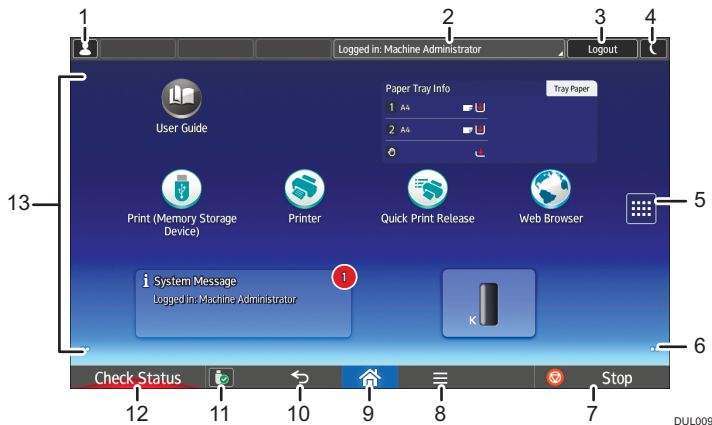

1. Logged-in user icon

When user authentication is enabled, an icon is displayed that indicates that users are logged in.

Press the icon to show the names of the users that are currently logged in.

2. System message

Displays messages from the machine system and applications.

3. [Login]/[Logout]

These keys are displayed when user authentication is enabled. When you press [Login], the authentication screen appears. If you have been already logged in to the machine, [Logout] appears. To log out of the machine, press [Logout].

For details about how to log in and out, see "Logging in to the Printer", Operating Instructions.

4. [Energy Saver] 🌙

Press to switch to Sleep mode.

For details about the modes, see page 31 "Saving Energy".

5. Application list icon 

Press to display the application list. You can create shortcuts to the applications on the [Home] screen.

To use an application displayed in the [Widgets] tab and [Program] tab, create a shortcut for the application on the [Home] screen. For details, see "Customizing the [Home] Screen", Operating Instructions.

6. Icons to switch between screens 

Press to switch between the five home screens. The icons appear at the bottom right and left of the screen, the number of icons indicates the number of screens on each side of the current screen.

7. [Stop]

Press to stop a job in progress.

8. [Menu] 

Displays the menu screen of the application you are using. Depending on the application you are using, this key may be disabled. You can also press this key in the [Home] screen to restore the [Home] screen's settings to their defaults.

9. [Home] 

Press to display the [Home] screen.

10. [Return] 

Press this key to return to the previous screen while Screen Features are enabled or applications are used. Depending on the application you are using, this key may be disabled. You can specify whether this key is enabled or not in some applications. For details about the settings, see "Screen Features", Operating Instructions.

11. [Media Information] 

Press to remove the inserted SD card or USB flash memory device from the media slot. For details, see "Removing an SD Card" or "Removing a USB Flash Memory Device", Operating Instructions.

12. [Check Status]

Press to check the machine's system status, operational status of each function, and current jobs. You can also display the job history and the machine's maintenance information.

13. Icon display area

Displays the function or application icons and widgets. Displayed icons differ between the five home screens. For details about icons on each screen, see page 23 "Main Icons on the [Home] Screen".

You can also add shortcuts and arrange icons using folders. For details, see "Customizing the [Home] Screen", Operating Instructions.







Note







- You can change the [Home] screen's wallpaper. For details, see "Changing the [Home] Screen's Wallpaper", Operating Instructions.
- You can switch modes by pressing icons on the [Home] screen. You can also switch modes by pressing the function keys. For details about the function keys, see "Changing Modes by Pressing the Function Keys", Operating Instructions.
- You cannot switch modes in any of the following situations:
 - When accessing the following screens:

- Machine Features
 - Maintenance: Print
 - Maintenance: Image
 - Counter
 - Inquiry
 - Address Book Management
 - Tray Paper Settings
 - Current Job / Job History
- The [Home] screen is set as the default screen when the machine is turned on. You can change this default setting under Function Priority. See "Screen Features", Operating Instructions.

Main Icons on the [Home] Screen

The following icons are displayed on the [Home] screen as a factory default:

Icon	Description
Printer 	Allows you to make settings for using the machine as a printer easily. For details, see "Checking the Printer Status from the Printer Icon", Operating Instructions.
Print (Memory Storage Device) 	Allows you to print files from a memory storage device. For details, see "Using the Print (Memory Storage Device) Function", Operating Instructions.
Quick Print Release 	Allows you to print files easily. For details, see "Using the Quick Print Release Function", Operating Instructions.
Printer (Classic) 	Press to make settings for using the machine as a printer.
Web Browser 	Press to display Web pages. For details, see "Using the Browser Function", Operating Instructions.
User Guide 	Press to display the manuals for the machine.
Address Book Management 	Press to display the Address Book. For details about how to use the Address Book, see "Address Book", Operating Instructions.

Icon	Description
Application Site 	Press to display Application site. Allows you to download applications for your machine. For details, see "How to Use the Application Site", Operating Instructions.
User Tools 	Press to display the screen for the machine's initial settings.
System Mes. Widget 	Displays messages from the machine system and applications.
Change Langs. Widget 	Allows you to change the on-screen language.
Supply Info Widget 	Displays the remaining amount of toner.
Paper Tray Info Widget 	Displays the tray's settings and the amount of paper remaining. In Energy Saver mode, this widget is dimmed and no longer reflects the tray's settings or the amount of paper remaining.
Embedded software applications	When an embedded software application is installed, a function icon for the application is displayed on the [Home] screen.

You can add icons to the [Home] screen to customize the machine. For details about adding icons to the [Home] screen, see page 28 "Adding Icons to the [Home] Screen".

[Printer (Classic)] Screen

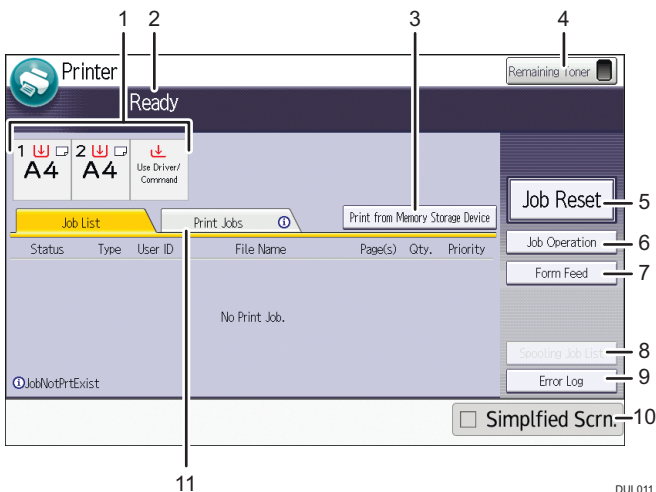

1. Paper tray status indicators

Displays paper tray settings.

2. Operational status or messages

Displays current machine status, such as "Ready", "Offline", and "Printing...". Information about the print job (user ID and document name) appears in this section.

3. [Print from Memory Storage Device]

Press to display the screen for printing files stored on memory storage devices directly.

4. Supply Information

Displays the remaining amount of toner.

5. [Job Reset]

Press to cancel the current print job.

If you press it when the Hex Dump is selected, Hex Dump is canceled.

6. [Job Operation]

Press to suspend a job being processed.

7. [Form Feed]

Press to print all the data left in the machine's input buffer.

8. [Spooling Job List]

Press to display spooled jobs.

9. [Error Log]

Press to display the error logs of print jobs sent from a computer.

10. [Simplified Scrn.]

Press to switch to a simplified screen. For details, see "Switching Screen Patterns", Operating Instructions.

11. [Print Jobs]

Press to display print jobs sent from a computer.

[Information] Screen

To raise awareness of resource conservation, you can configure the machine to display the reduction in paper usage.

When user authentication is enabled, the screen is displayed when you log in to the machine. When user authentication is not enabled, the screen is displayed after returning from Sleep mode or after a system reset. The [Information] screen appears when the power is turned on, regardless of the authentication settings.

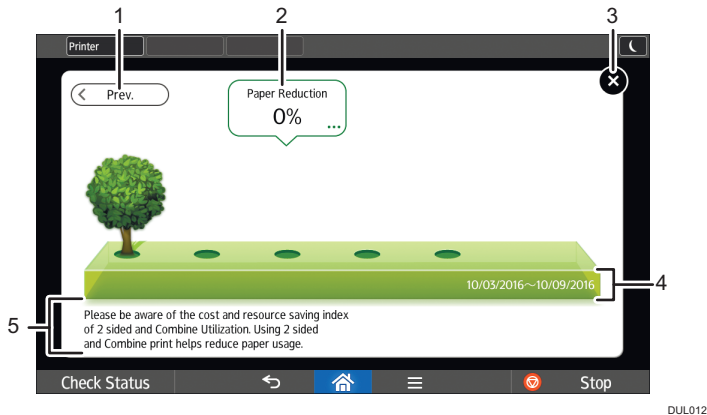

DUL012

1. [Prev.] / [Crnt.]

Press to switch between the [Information] screen of the previous count period and that of the current count period.

2. Paper Reduction

Shows the amount of paper saved by using the duplex and combine printing functions. The figure indicates the percentage of paper saved from the total of all the paper used. As the figures become greater, the number of the trees increases. If the paper reduction ratio exceeds a certain level, the trees will bear fruit.

Press [...] on the bottom right of the balloon to display the following items:

- Total Print Pages:
Total number of pages printed in the current count period is displayed.
- 2 sided Utilization:
The ratio of 2-sided prints to the total number of prints is displayed.
The higher the ratio is, the more leaves are displayed.
- Combine Utilization:
The ratio of combined prints to the total number of prints is displayed.
The higher the ratio is, the more leaves are displayed.

3. [Close]

Press this to close the [Information] screen and return to operation.

4. Count periods

The current and previous count periods are displayed.

5. Message

A message from the administrator is displayed.

Possible Operations on the Screen

- Pinch-in

Place your thumb and forefinger on the screen, and then pinch the fingers together to zoom out the screen. Double-tapping can also be effective for this operation.

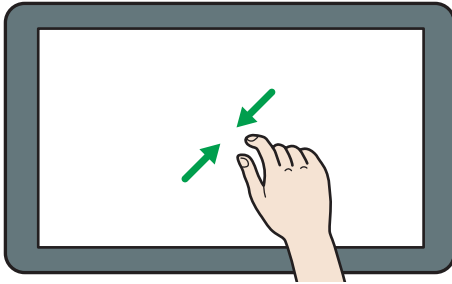

DNE103

- Pinch-out

Place your thumb and forefinger on the screen, and then spread the fingers apart to zoom in the screen. Double-tapping can also be effective for this operation.

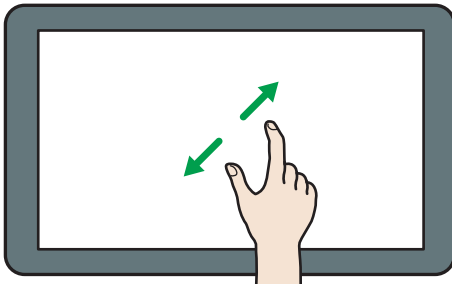

DNE104

- Flick

Flick your finger to the right or left on the screen to switch between screens.

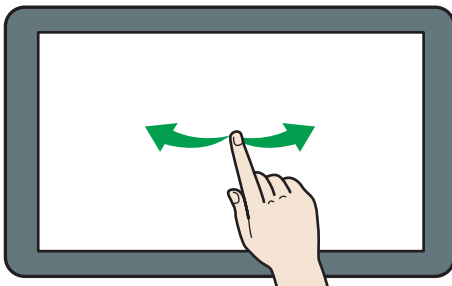

DNE102

- Long tap

Place your finger on the screen and hold it there until the next screen appears. You can display the menu screen of the application you are using.

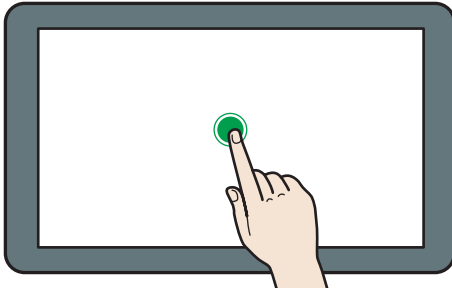

DNE101

- Drag

Slide your finger while pressing the screen. You can move icons, folders, etc., to where you want to place them.

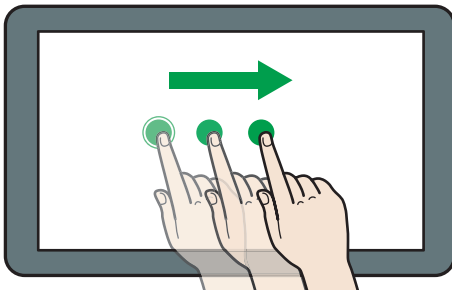



DNE111

Adding Icons to the [Home] Screen

Adding shortcuts to the [Home] screen

You can add shortcuts to the machine's functions.

You can display the icons for the machine's functions and the embedded software applications after you delete them from the [Home] screen.

1. Press [Home]  at the bottom of the screen in the center.
2. Press .
3. Press the [Apps] tab to add a shortcut to an application other than [Printer (Classic)]. Press the [Program] tab to add a shortcut to [Printer (Classic)].
4. Press and hold down the application icon to add a shortcut to an application other than [Printer (Classic)]. Press and hold down the [Classic Applications] icon to add a shortcut to [Printer (Classic)].



The image of where the shortcut is to be placed on the [Home] screen is displayed.

5. Drag the icon to where you want to place it on the screen.

If you want to add a shortcut to [Printer (Classic)], proceed to Step 6.

6. Select [Printer (Classic)].**Adding shortcuts to bookmarks on the [Home] screen**

You can add shortcuts to bookmarks that have been registered in favorites in the Web Browser to the [Home] screen.



1. Press [Home]  at the bottom of the screen in the center.
2. Press .
3. Press the [Program] tab.
4. Press and hold down the [Bookmark] icon.

The image of where the shortcut is to be placed on the [Home] screen is displayed.

5. Drag the icon to where you want to place it on the screen.
6. Select the bookmark you want to add from the bookmark list.

Adding widgets to the [Home] screen

You can add widgets to the [Home] screen to show the remaining amount of toner or change the display language.

1. Press [Home]  at the bottom of the screen in the center.
2. Press .
3. Press the [Widget] tab.
4. Press and hold down the widget icon you want to add.

The image of where the widget is to be placed on the [Home] screen is displayed.

5. Drag the icon to where you want to place it on the screen.

Turning On/Off the Power

1

Turning On/Off the Power

★ Important

- When you push the main power switch, wait at least 10 seconds after it is confirmed that the main power indicator has lit up or gone out.

The main power switch is on the right side of the machine. When this switch is turned on, the main power turns on and the main power indicator on the right side of the control panel lights up. When this switch is turned off, the main power turns off and the main power indicator on the right side of the control panel goes out. When this is done, machine power is off.

↓ Note

- This machine automatically enters Fusing Unit Off mode or Sleep mode if you do not use it for a while. For details, see page 31 "Saving Energy".

Turning on the main power

1. Make sure the power cord is firmly plugged into the wall outlet.
2. Open the main power switch cover, and push the main power switch.

The main power indicator goes on.

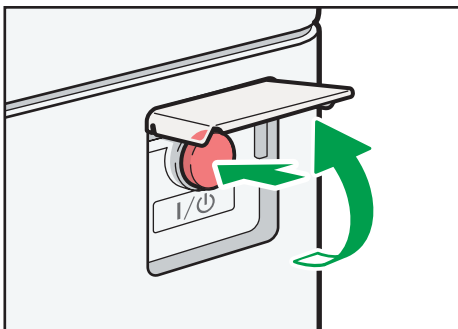

DLV015

↓ Note

- After you switch the main power on, a screen may appear to indicate that the machine is initializing. Do not switch the power off during this process. Initialization takes about 7 minutes.
- Application icons appear on the [Home] screen as the applications start running.

Turning off the main power

CAUTION

- When disconnecting the power cord from the wall outlet, always pull the plug, not the cord. Pulling the cord can damage the power cord. Use of damaged power cords could result in fire or electric shock.

Important

- Do not turn off the power while the machine is in operation.
- Do not hold down the main power switch while turning off the main power. Doing so forcibly turns off the machine's power and may damage the hard disk or memory and cause malfunctions.

1. Open the main power switch cover, and push the main power switch.

The main power indicator goes out. The main power turns off automatically when the machine shuts down. If the screen on the control panel does not disappear, contact your service representative.

Saving Energy

This machine has the following energy saving functions.

Fusing Unit Off mode

If you do not use the machine for a certain period after an operation, the machine makes a clicking sound and enters Fusing Unit Off mode.

When the machine is in Fusing Unit Off mode, the display is on but the fusing unit heater is off to save energy. In this mode, you can change the machine's settings on the control panel. However, the machine must exit this mode to print.

You can change the amount of time that the machine waits before switching to Fusing Unit Off mode under [Fusing Unit Off Mode (Energy Saving) On/Off]. For details, see "Timer Settings", Operating Instructions.

To exit Fusing Unit Off mode, do one of the following:

- Start print jobs

Sleep mode

If the machine remains inactive for a specified period or [Energy Saver]  is pressed, it enters Sleep mode to further reduce the electricity it consumes. For details, see "System Settings", Operating Instructions.

You can change the amount of time that the machine waits before switching to Sleep mode under [Sleep Mode Timer]. For details, see "Timer Settings", Operating Instructions.

To exit Sleep mode, do one of the following:

- Touch the display panel

- Open the front cover or right cover

Note

- When a machine is in Fusing Unit Off mode, the main power indicator is lit. In Sleep mode, the main power indicator flashes slowly.
- The energy saving functions will not operate in the following cases:
 - When fixed warm-up is in progress
 - When operations are suspended during printing
 - When a warning message appears (The machine enters Fusing Unit Off mode unless the cover is open.)
 - When paper is jammed (The machine enters Fusing Unit Off mode except when the cover is open.)
 - When the Data In indicator is lit or flashing
- The machine does not enter Sleep mode in the following cases:
 - During communication with external equipment
 - When the hard disk is active
 - When the service call message appears
 - When the "Add Toner" message appears
 - When toner is being replenished
 - When one of the following screens is displayed:
 - Machine Features
 - Counter
 - Inquiry
 - Address Book Management
 - Tray Paper Settings
 - When data is being processed
 - When a recipient is being registered in the address list or group dial list
 - When the sample print, locked print, hold print, or stored print screen is displayed
 - When the screen of a document that was stored under the printer function appears
 - When the internal cooling fan is active
 - When accessing the machine using Web Image Monitor

Accessing User Tools

This section describes how to access the User Tools menu.

User Tools allow you to change or set defaults, and have eight types of menus:

- **Screen Features**
Specify the settings of the control panel.
- **Machine Features**
Specify the settings of the machine.
- **Maintenance: Print**
Displays settings made under Maintenance: Print menu.
- **Maintenance: Image**
Displays settings made under Maintenance: Image menu.
- **Counter**
You can confirm the number of sheets you have printed.
- **Inquiry**
You can confirm the contact info for inquiries.
- **Address Book Management**
You can manage user information of the machine.
- **Tray Paper Settings**
Specify the settings of the paper.



↓ Note

- Operations for system settings differ from normal operations. Always quit User Tools when you have finished.
- Any changes you make with User Tools remain in effect even if the main power switch or operation switch is turned off, or [Energy Saver] or [Reset] is pressed.

Changing Default Settings

This section describes how to change the settings of User Tools.

★ Important

- If **Administrator Authentication Management** is specified, contact your administrator.
1. Press [Home] () at the bottom of the screen in the center.
 2. Flick the screen to the left, and then press the [User Tools] () icon.

3. Select the settings you want to change.

To change the user tool in [System Settings], press [Machine Features], and then press [System Settings].

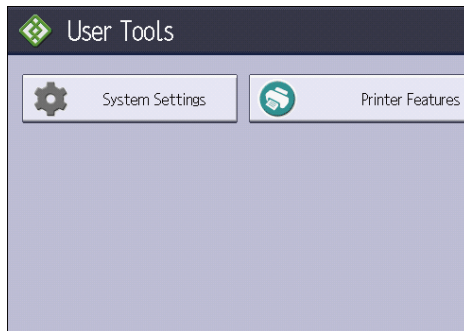

4. Change settings by following instructions on the display, and then press [OK].

Quitting User Tools

This section describes how to quit the settings of User Tools.

1. Close the initial settings screen.

- When configuring Screen Features
Press [Home] (🏠) at the bottom of the screen in the center.
- When configuring Machine Features, Maintenance: Print, Counter, Inquiry, Address Book Management, or Tray Paper Settings
Press [User Tools] (⚙️) on the top right of the screen, and then press [Home] (🏠) at the bottom of the screen in the center.

⬇️ Note

- When configuring Machine Features, Maintenance: Print, Maintenance: Image, Counter, Inquiry, Address Book Management, or Tray Paper Settings, you can also quit User Tools by pressing [Exit] or [Close] on the top right of the screen and [Home] (🏠) at the bottom of the screen in the center.

Using Web Image Monitor

Using Web Image Monitor, you can check the machine status and change settings.

★ Important

- You cannot configure the machine settings using Web Image Monitor from a computer connected to the USB device server's network. Be sure to access Web Image Monitor from a computer connected to the machine's network.

Available operations

The following operations can be remotely performed using Web Image Monitor from a client computer.

- Displaying machine status or settings
- Checking the print job status or history
- Interrupting currently printing jobs
- Resetting the machine
- Managing the Address Book
- Making machine settings
- Making network protocol settings
- Making security settings

Configuring the machine

To perform the operations from Web Image Monitor, TCP/IP is required. After the machine is configured to use TCP/IP, operations from Web Image Monitor become available.

Recommended web browser

- Windows:
 - Internet Explorer 7.0 or later
 - Microsoft Edge 20 or later
 - Firefox 10 and 15 or later
 - Google Chrome Version: 19 or later
- OS X:
 - Firefox 10 and 15 or later
 - Safari 3.0 or later
 - Google Chrome Version: 19 or later

Web Image Monitor supports screen reader software. We recommend JAWS 7.0 or a later version.

Displaying Top Page

This section explains the Top Page and how to display Web Image Monitor.

★ Important

- When entering an IPv4 address, do not begin segments with zeros. For example: If the address is "192.168.001.010", you must enter it as "192.168.1.10".

1. Start your web browser.

2. Enter "http://(machine's IP address or host name)/" in your web browser's URL bar.

Top Page of Web Image Monitor appears.

If the machine's host name has been registered on the DNS or WINS server, you can enter it.

When setting SSL, a protocol for encrypted communication, under environment which server authentication is issued, enter "https://(machine's IP address or host name)/".

Web Image Monitor is divided into the following areas:

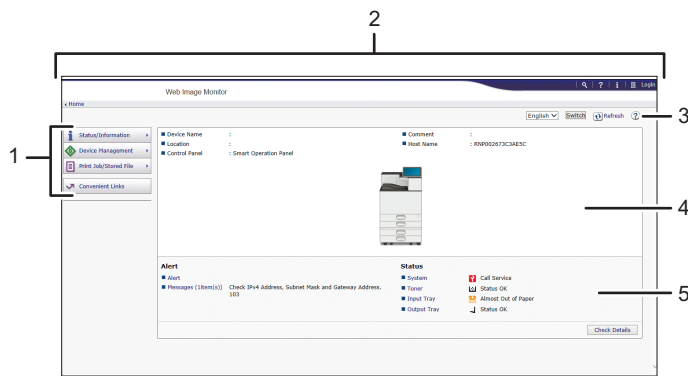

DUL013



1. Menu area

If you select a menu item, its content will be shown.

2. Header area

Display icons for the links to Help and the keyword search function. This area also displays [Login] and [Logout], which allows you to switch between the administrator and guest mode.

3. Refresh/Help

 (Refresh): Click  at the upper right in the work area to update the machine information. Click the web browser's [Refresh] button to refresh the entire browser screen.

 (Help): Use Help to view or download Help file contents.

4. Basic Information area

Display the basic information of the machine.

5. Work area

Display the contents of the item selected in the menu area.

Replenishing and Replacing Consumables

This section explains precautions for adding toner and staples, and how to replace the other consumables.

1

Adding Toner

WARNING

- Do not incinerate toner (new or used) or toner containers. Doing so risks burns. Toner will ignite on contact with naked flame.
- Do not store toner (new or used) or toner containers anywhere near naked flames. Doing so risks fire and burns. Toner will ignite on contact with naked flame.
- Do not use a vacuum cleaner to remove spilled toner (including used toner). Absorbed toner may cause a fire or explosion due to electrical contact flickering inside the vacuum cleaner. However, it is possible to use a vacuum cleaner that is explosion-proof and dust ignition-proof. If toner is spilled on the floor, remove the spilled toner slowly using a wet cloth, so that the toner is not scattered.
- The following explains the warning messages on the plastic bag used in this product's packaging.
 - Keep the polythene materials (bags, etc.) supplied with this machine away from babies and small children at all times. Suffocation can result if polythene materials are brought into contact with the mouth or nose.

CAUTION

- Do not crush or squeeze toner containers. Doing so can cause toner spillage, possibly resulting in dirtying of skin, clothing, and floor, and accidental ingestion.
- Store toner (new or used), toner containers, and components that have been in contact with toner out of reach of children.
- If toner or used toner is inhaled, gargle with plenty of water and move into a fresh air environment. Consult a doctor if necessary.
- If toner or used toner gets into your eyes, flush immediately with large amounts of water. Consult a doctor if necessary.

⚠ CAUTION



- If toner or used toner is swallowed, dilute by drinking a large amount of water. Consult a doctor if necessary.
- When removing jammed paper or replacing toner, avoid getting toner (new or used) on your clothing. If toner comes into contact with your clothing, wash the stained area with cold water. Hot water will set the toner into the fabric and make removing the stain impossible.
- When removing jammed paper or replacing toner, avoid getting toner (new or used) on your skin. If toner comes into contact with your skin, wash the affected area thoroughly with soap and water.
- When replacing a toner or waste toner container or consumables with toner, make sure that the toner does not splatter. Put the waste consumables in a bag after they are removed. For consumables with a lid, make sure that the lid is shut.

★ Important

- Always replace the toner cartridge when a notification appears on the machine.
- Fault may occur if you use toner other than the recommended type.
- When adding toner, do not turn off the main power. If you do, settings will be lost.
- Store toner where it will not be exposed to direct sunlight, temperatures above 35°C (95°F), or high humidity.
- Store toner horizontally.
- Do not shake the toner cartridge with its mouth down after removing it. Residual toner may scatter.
- Do not repeatedly install and remove toner cartridges. This will result in toner leakage.

Follow the instruction on the screen regarding how to replace a toner cartridge.

↓ Note

- If "Toner Cartridge is almost empty." appears on the system message widget, the toner has almost run out. Have a replacement toner cartridge at hand.
- If  appears when there is a lot of toner, hold the cartridge with the opening upward, shake it well, and then reinstall it.
- When "No Toner" appears on the system message widget, you can check the name of the required toner and the replacement procedure using the [Add Toner] screen. To display the [Add Toner] screen, press [Check Status], and then press [Check] in the [Mach. Status] area in the [Mach./Applic. Stat] tab.
- For details about how to check contact number where you can order supplies, see "Inquiry", Operating Instructions.

Adding Staples

CAUTION

- When closing the finisher, keep hands clear of the finisher's upper surface.

Important

- Stapling failures or jams may occur if you use a staple cartridge other than that recommended.

Follow the instruction on the screen regarding how to add staples.

Note

- If you cannot pull out the upper unit, there are staples remaining inside the cartridge. Use all the staples, and do not add more.

Replacing Other Consumables

Refer to the maintenance guide provided with the new items for the replacement.

WARNING

- Do not incinerate toner (new or used) or toner containers. Doing so risks burns. Toner will ignite on contact with naked flame.

CAUTION

- Store toner (new or used), toner containers, and components that have been in contact with toner out of reach of children.
- The fusing unit becomes very hot. When installing a new fusing unit, turn off the printer and wait at least an hour after power off before replacing parts. Not allowing the printer to cool may result in burns.

Important

- Exposure to light reduces drum unit performance. Replace the unit as quickly as possible.
- Do not pull out the drum unit quickly or with force as it may fall.
- Take care that nothing comes into contact with the photo conductor area of the drum unit.
- When taking the drum unit out of the box, be sure to hold the unit by the handle on the top of the unit. Do not touch any parts of the drum unit.
- Place no objects on the front or inner cover.
- Waste toner bottles cannot be reused.

- **Purchasing and storing extra waste toner bottles is recommended.**
- **Before removing the waste toner bottle from the printer, spread paper or some other material around the area to keep toner from dirtying your workspace.**

Maintenance Kit A

Replace the Maintenance Kit A when the following message appears on the display:

"Replacement of Maintenance Kit A will soon be necessary. A new unit is required. Please contact your local vendor."

When the following message appears on the display, the Maintenance Kit A should be replaced soon.

"Replacement of Maintenance Kit A is now necessary. Replace Maintenance Kit A. Press [Check Status]."

Maintenance Kit B

Replace the Maintenance Kit B when the following message appears on the display:

"Replacement of Maintenance Kit B will soon be necessary. A new unit is required. Please contact your local vendor."

When the following message appears on the display, the Maintenance Kit B should be replaced soon.

"Replacement of Maintenance Kit B is now necessary. Replace Maintenance Kit B. Press [Check Status]."

2. Loading Paper

This chapter describes available trays for each paper size and type, and explains how to load paper in paper trays.

Loading Paper

2

Precautions for Loading Paper

CAUTION

- When loading paper, take care not to trap or injure your fingers.

Important

- Do not stack paper over the limit mark.
- While Mailbox or the Internal Multi-Folding unit is attached, pull out only one paper tray at a time.

Note

- To prevent multiple sheets from being fed at once, fan the paper before loading it.
- If you load paper when only a few sheets of paper remain in the tray, multiple sheet feeding may occur. Remove any remaining paper, stack them with the new sheets of paper, and then fan the entire stack before loading it into the tray.
- Straighten curled or warped paper before loading.
- For details about the paper sizes and types that can be used, see page 51 "Recommended Paper Sizes and Types".
- You might at times hear a rustling noise from paper moving through the machine. This noise does not indicate a malfunction.

Loading Paper into Paper Trays

Every paper tray is loaded in the same way.

In the following example procedure, paper is loaded into Tray 2.

Important

- Check the paper edges are aligned at the right side.
- If a paper tray is pushed vigorously when putting it back into place, the position of the tray's side fences may slip out of place.

- When loading a low number of sheets, be sure not to squeeze the side fences in too tightly. If the side fences are squeezed too tightly against the paper, the edges may crease, thin paper may wrinkle, or the paper may misfeed.

1. Check that paper in the paper tray is not being used, and then pull the tray carefully out until it stops.

2

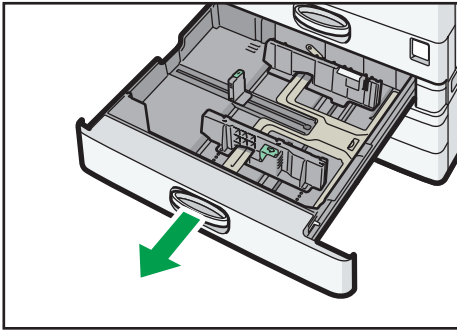

DRY222

2. Square the paper and load it print side up.

Do not stack paper over the limit mark.

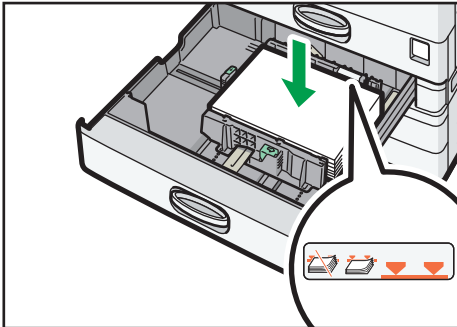

DUL049

3. Align the end and side fences gently against the paper you loaded.

Make sure that there is no space between the paper and the side fences or end fence.

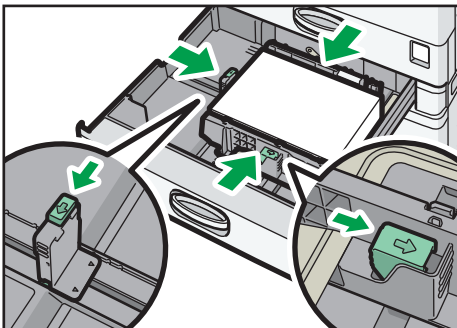

DUL048

4. Carefully push the paper tray fully in.

Note

- Various sizes of paper can be loaded in the paper trays by adjusting the positions of side fences and end fence. For details, see "Changing the Paper Size in Paper Trays", Operating Instructions.
- You can load envelopes in the paper trays. When loading envelopes, place them in the correct orientation. For details, see page 58 "Envelopes".

Loading Paper into the Bypass Tray

Use the bypass tray to use OHP transparencies, adhesive labels, translucent paper, and paper that cannot be loaded in the paper trays.

★ Important

- The maximum number of sheets you can load at the same time depends on paper type. Do not stack paper over the limit mark. For the maximum number of sheets you can load, see page 51 "Recommended Paper Sizes and Types".

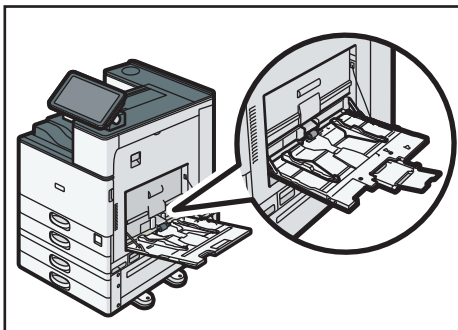
1. Open the bypass tray.

DUL008

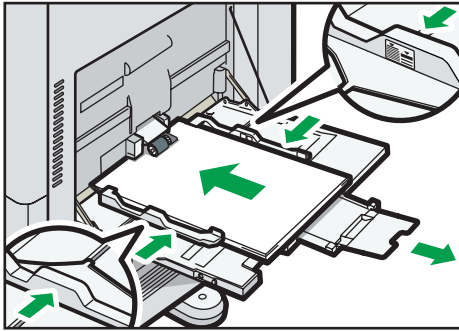

2. Load the paper face down until you hear the beep.**3. Align the paper guides to the paper size.**

If the guides are not flush against the paper, images might be skewed or paper misfeeds might occur.





DCG018

↓ Note



- When you use the bypass tray, it is recommended to load the paper in  orientation.
- Certain types of paper might not be detected properly when placed on the bypass tray. If this happens, remove the paper and place it on the bypass tray again.
- Pull the extender out when loading A4  , 8 1/2 × 11  or larger size paper in the bypass tray.
- When loading thick paper, thin paper, or OHP transparencies, specify the paper size and the paper type.
- Letterhead paper must be loaded in a specific orientation. For details, see page 49 "Loading Orientation-fixed Paper or Two-sided Paper".
- You can load envelopes into the bypass tray. Envelopes must be loaded in a specific orientation. For details, see page 58 "Envelopes".
- Specify the sizes of paper that are not automatically detected. For details about the sizes that can be detected automatically, see page 51 "Recommended Paper Sizes and Types". For details about how to specify sizes, see page 61 "Printing from the Bypass Tray".
- When printing from a computer using the bypass tray, see page 61 "Printing from the Bypass Tray".
- When [Notification Sound] is set to [No Sound], it does not sound if you load paper into the bypass tray. For details about [Notification Sound], see "Screen Features", Operating Instructions.

Loading Paper into Tray 3 (LCT)

 **Region A** (mainly Europe and Asia)

Tray 3 (LCT) can hold A4  paper only. If you want to print on 8 1/2 × 11  from Tray 3 (LCT), contact your service representative.

 **Region B** (mainly North America)

Tray 3 (LCT) can hold 8 1/2 × 11  paper only. If you want to print on A4  from Tray 3 (LCT), contact your service representative.

★ Important

- When paper loaded in the right side of Tray 3 (LCT) runs out, paper on the left is automatically shifted to the right. Do not pull out Tray 3 (LCT) while the tray is moving paper; wait until sounds stop coming from the tray.
- For the right stack, align the right edge of the paper with the right edge of the tray. For the left stack, align the left edge of the paper to the left edge of the tray.

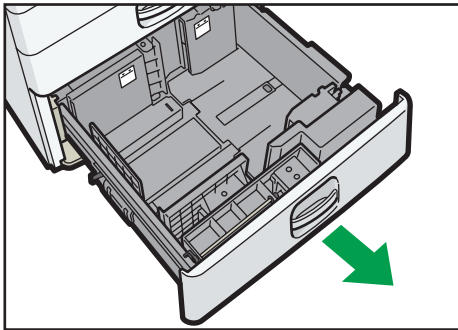
1. Carefully pull out the paper tray until it stops.

CVA017

2. Square the paper and load it print side up.

Do not stack paper over the limit mark.

- Whole tray pulled out

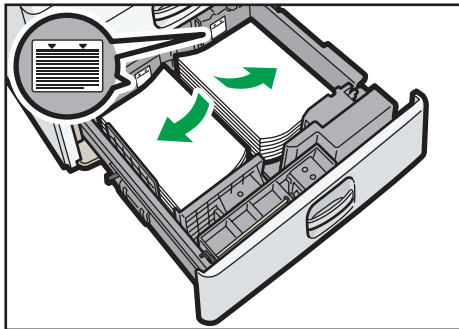

CVA018

- Left half of the tray pulled out

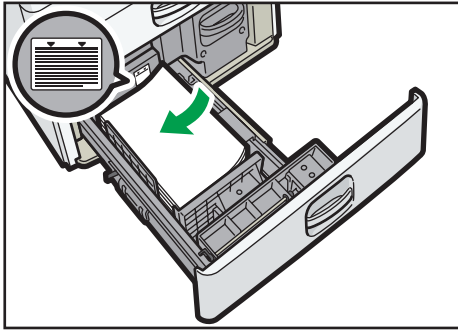

3. Carefully push the paper tray fully in.

Note

- You can load paper even if Tray 3 (LCT) is in use. It is okay to pull out the left half of the tray while Tray 3 (LCT) is in use.
- Load 30 or more sheets of paper in the left half of the tray.

Loading Paper into the Large Capacity Tray (LCT)

Region A (mainly Europe and Asia)

The large capacity tray (LCT) can hold A4 paper only. If you want to print on 8 1/2 × 11 or B5 JIS from the large capacity tray (LCT), contact your service representative.

Region B (mainly North America)

The large capacity tray (LCT) can hold 8 1/2 × 11 paper only. If you want to print on A4 or B5 JIS from the large capacity tray (LCT), contact your service representative.

Important

- Check the paper edges are aligned at the left side.
1. Check that paper in the paper tray is not being used, and then open the right cover of the large capacity tray (LCT).

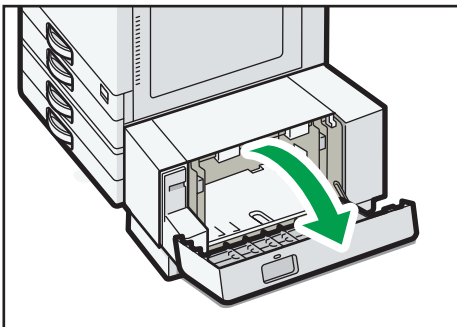

2. Load paper into the paper tray with the print side down.

Do not stack paper over the limit mark.

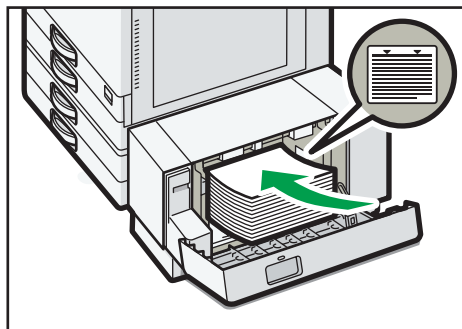

DRY225

3. Close the right cover of the large capacity tray (LCT).

Loading Orientation-fixed Paper or Two-sided Paper

Orientation-fixed (top to bottom) or two-sided paper (for example, letterhead paper, punched paper, or copied paper) might not be printed correctly, depending on how the originals and paper are placed.



Settings for the User Tools





Specify [Auto Detect] or [On (Always)] for [Letterhead Setting] in [System] under the Printer Features menu, and then place the paper as shown below.

For details about the letterhead settings, see "System", Operating Instructions.

Paper orientation

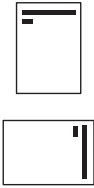
The meanings of the icons are as follows:

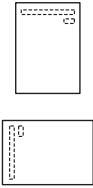
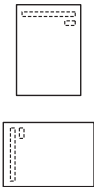
Icon	Meaning
	Place or load paper printed side face up.
	Place or load paper printed side face down.

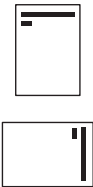
Print side	Trays 1-4	Tray 3 (LCT)	Large capacity tray (LCT)	Bypass tray
One-sided				
Two-sided				

Note

- To print on letterhead paper when [Auto Detect] is specified for [Letterhead Setting], you must specify [Letterhead] as the paper type in the printer driver's settings.
- If a print job is changed partway through printing from one-sided to two-sided printing, one-sided output after the first print may be printed facing a different direction. To ensure all paper is output facing the same direction, specify different input trays for one-sided and two-sided printing. Note also that two-sided printing must be disabled for the tray specified for one-sided printing.
- For details about how to make two-sided prints, see "Printing on Both Sides of Sheets", Operating Instructions.

Recommended Paper



Recommended Paper Sizes and Types





This section describes recommended paper sizes and types.

★ Important

- If you use paper that curls, either because it is too dry or too damp, a staple clogging or paper jam may occur.
- Do not use paper designed for inkjet printers, as these may stick to the fusing unit and cause a misfeed.
- When you load OHP transparencies, check the front and back of the sheets, and place them correctly, or a misfeed might occur.





Trays 1–4















Paper type and weight	Paper size	Paper capacity
60–300 g/m ² (16 lb. Bond–110 lb. Cover) Plain Paper 1–Thick Paper 4	Paper sizes that can be detected automatically *1:  Region A A3□, A4□□, A5□, B4 JIS□, B5 JIS□□, 8 1/2 × 11□  Region B A4□, A5□, B5 JIS□, 11 × 17□, 8 1/2 × 14□, 8 1/2 × 11□□, 7 1/4 × 10 1/2□, 8 1/2 × 13 2/5□	550 sheets

Paper type and weight	Paper size	Paper capacity
<p>60–300 g/m² (16 lb. Bond–110 lb. Cover) Plain Paper 1–Thick Paper 4</p>	<p>Select the paper size using the Tray Paper Settings menu^{*1}:</p> <p> Region A</p> <p>A5□, A6□, B6 JIS□, 11 × 17□, 8¹/₂ × 14□, 8¹/₂ × 13□, 8¹/₂ × 11□, 8¹/₄ × 14□, 8¹/₄ × 13□, 8 × 13□, 8 × 10□, 7¹/₄ × 10¹/₂□□, 5¹/₂ × 8¹/₂□, 8K□, 16K□□, 11 × 15□, 10 × 14□, 8¹/₂ × 13²/₅□</p> <p> Region B</p> <p>A3□, A4□, A5□, A6□, B4 JIS□, B5 JIS□, B6 JIS□, 8¹/₂ × 13□, 8¹/₄ × 14□, 8¹/₄ × 13□, 8 × 13□, 8 × 10□, 7¹/₄ × 10¹/₂□, 5¹/₂ × 8¹/₂□, 8K□, 16K□□, 11 × 15□, 10 × 14□</p>	<p>550 sheets</p>
<p>60–300 g/m² (16 lb. Bond–110 lb. Cover) Plain Paper 1–Thick Paper 4</p>	<p>Custom size^{*2}:</p> <p> Region A</p> <p>Vertical: 90.0–297.0 mm Horizontal: 148.0–431.8 mm</p> <p> Region B</p> <p>Vertical: 3.55–11.69 inches Horizontal: 5.83–17.00 inches</p>	<p>550 sheets</p>
<p>Envelopes</p>	<p>Select the paper size using the Tray Paper Settings menu:</p> <p>4¹/₈ × 9¹/₂□□, 3⁷/₈ × 7¹/₂□, C5 Env□□, C6 Env□□, DL Env□□</p>	<ul style="list-style-type: none"> • □: 50 sheets • □: <p>Double flap: 15 sheets Single flap: 25 sheets</p>

- *1 Adjust the supporting side fence before loading B4 JIS, A3, or 11 × 17 paper into Trays 3–4.
- *2 When loading paper with a vertical length of more than 279.4 mm (11.0 inches) in Tray 1, use paper that has a horizontal width of 420 mm (16.6 inches) or less.

Bypass tray

Paper type and weight	Paper size	Paper capacity
52–300 g/m ² (14 lb. Bond–110 lb. Cover) Thin Paper–Thick Paper 4	<p>Paper sizes that can be detected automatically:</p> <p> Region A</p> <p>A3, A4, A5, A6, B4 JIS, B5 JIS, B6 JIS</p> <p> Region B</p> <p>A5, B5 JIS, 11 × 17, 8¹/₂ × 11, 5¹/₂ × 8¹/₂, 7¹/₄ × 10¹/₂, 12 × 18</p>	<ul style="list-style-type: none"> • 100 sheets (up to 10 mm in height) • Thick Paper 1: 40 sheets • Thick Paper 2–Thick Paper 3: 20 sheets • Thick Paper 4: 16 sheets
52–300 g/m ² (14 lb. Bond–110 lb. Cover) Thin Paper–Thick Paper 4	<p>*1</p> <p> Region A</p> <p>11 × 17, 8¹/₂ × 14, 8¹/₂ × 13, 8¹/₂ × 11, 8¹/₄ × 14, 8¹/₄ × 13, 8 × 13, 8 × 10, 7¹/₄ × 10¹/₂, 5¹/₂ × 8¹/₂, 8K, 16K, 12 × 18, 11 × 15, 10 × 14, 8¹/₂ × 13²/₅</p> <p> Region B</p> <p>A3, A4, A5, A6, B4 JIS, B5 JIS, B6 JIS, 8¹/₂ × 14, 8¹/₂ × 13, 8¹/₄ × 14, 8¹/₄ × 13, 8 × 13, 8 × 10, 7¹/₄ × 10¹/₂, 8K, 16K, 11 × 15, 10 × 14, 8¹/₂ × 13²/₅</p>	<ul style="list-style-type: none"> • 100 sheets (up to 10 mm in height) • Thick Paper 1: 40 sheets • Thick Paper 2–Thick Paper 3: 20 sheets • Thick Paper 4: 16 sheets

Paper type and weight	Paper size	Paper capacity
52–300 g/m ² (14 lb. Bond–110 lb. Cover) Thin Paper–Thick Paper 4	Custom size * ² :  Region A Vertical: 90.0–304.8 mm * ³ Horizontal: 148.0–600.0 mm * ⁴  Region B Vertical: 3.55–12.00 inches * ³ Horizontal: 5.83–23.62 inches * ⁴	<ul style="list-style-type: none"> • 100 sheets (up to 10 mm in height) • Thick Paper 1: 40 sheets • Thick Paper 2–Thick Paper 3: 20 sheets • Thick Paper 4: 16 sheets
OHP transparencies	A4  , 8 1/2 × 11 	50 sheets
Translucent paper	A3  , A4  , B4 JIS  , B5 JIS 	1 sheet
Label paper (adhesive labels)	B4 JIS  , A4 	30 sheets
Envelopes	* ¹ 4 1/8 × 9 1/2  , 3 7/8 × 7 1/2  , C5 Env  , C6 Env  , DL Env 	10 sheets





*1 Select the paper size. See page 61 "Specifying Regular Sizes Using the Control Panel".





*2 Enter the paper size. See page 61 "Specifying a Custom Size Paper Using the Control Panel".

*3 When only the Internal Multi-Folding unit is installed, the vertical size range is limited to 90.0–297.0 mm (3.55–11.69 inches).

*4 Paper that has a horizontal length of 432 mm (17.1 inches) or more is prone to creasing, feed failures, and jamming.











Tray 3 (LCT)

Paper type and weight	Paper size	Paper capacity
60–300 g/m ² (16 lb. Bond–110 lb. Cover) Plain Paper 1–Thick Paper 4	 Region A A4   Region B 8 1/2 × 11 	1000 sheets × 2

Paper type and weight	Paper size	Paper capacity
60–300 g/m ² (16 lb. Bond–110 lb. Cover) Plain Paper 1–Thick Paper 4	*1  Region A 8 1/2 × 11   Region B A4 	1000 sheets × 2

*1 To load paper any of the sizes specified above, contact your service representative.

Large capacity tray (LCT)

Paper type and weight	Paper size	Paper capacity
60–300 g/m ² (16 lb. Bond–110 lb. Cover) Plain Paper 1–Thick Paper 4	 Region A A4   Region B 8 1/2 × 11 	1500 sheets
60–300 g/m ² (16 lb. Bond–110 lb. Cover) Plain Paper 1–Thick Paper 4	*1  Region A B5 JIS  , 8 1/2 × 11   Region B A4  , B5 JIS 	1500 sheets

*1 To load paper any of the sizes specified above, contact your service representative.

Paper Thickness

Paper Thickness ^{*1}	Paper weight
Thin Paper ^{*2}	52–59 g/m ² (14–15 lb. Bond)
Plain Paper 1	60–74 g/m ² (16–20 lb. Bond)
Plain Paper 2	75–81 g/m ² (20 lb. Bond)
Middle Thick	82–105 g/m ² (20–28 lb. Bond)
Thick Paper 1	106–169 g/m ² (28 lb. Bond–90 lb. Index)
Thick Paper 2	170–220 g/m ² (65–80 lb. Cover)

Paper Thickness ^{*1}	Paper weight
Thick Paper 3	221–256 g/m ² (80 lb. Cover–140 lb. Index)
Thick Paper 4	257–300 g/m ² (140 lb. Index–110 lb. Cover)

*1 Print quality will decrease if the paper you are using is close to the minimum or maximum weight. Change the paper weight setting to thinner or thicker.

*2 Depending on the type of thin paper, the edges may crease or the paper may be misfed.

↓ Note

- Certain types of paper, such as translucent paper or OHP transparencies, may produce noise when delivered. This noise does not indicate a problem and print quality is unaffected.
- The paper capacity described in the tables above is an example. Actual paper capacity might be lower, depending on the paper type.
- When loading paper, make sure the stack height does not exceed the limit mark of the paper tray.
- If multiple sheet feeding occurs, fan sheets thoroughly or load sheets one by one from the bypass tray.
- Flatten out curled sheets before loading them.
- Depending on the paper sizes and types, the print speed may be slower than usual.
- When loading thick paper of 106–300 g/m² (28 lb. Bond–110 lb. Cover), see page 57 "Thick paper".
- When loading envelopes, see page 58 "Envelopes".
- When printing onto letterhead paper, the paper placing orientation is different depending on which function you are using. For details, see page 49 "Loading Orientation-fixed Paper or Two-sided Paper".
- When loading label paper:
 - We recommend that you use specified label paper.
 - It is recommended to place one sheet at a time.
 - On the [Paper Type: Bypass Tray] screen under [Tray Paper Settings], select [Label Paper] in the [Paper Type] area, and then select the appropriate paper thickness in the [Paper Thickness] area.
- When loading OHP transparencies:
 - It is recommended to place one sheet at a time.
 - When printing on OHP transparencies from the computer, see page 62 "Specifying Thick Paper, Thin Paper, or OHP Transparencies for Paper Type Using the Control Panel".
 - Fan OHP transparencies thoroughly whenever you use them. This prevents OHP transparencies from sticking together, and from feeding incorrectly.



- Remove printed sheets one by one.
- When loading translucent paper:
 - When loading translucent paper, always use long grain paper, and set the paper direction according to the grain.
 - Translucent paper easily absorbs humidity and becomes curled. Remove curl in the translucent paper before loading.
 - Remove printed sheets one by one.
- After continuous printing of A5, A6, envelopes or other smaller custom paper sizes, printing on different sized paper may require a wait of up to 1 minute for adjustments.

Thick paper

This section gives you various details about and recommendations concerning thick paper.

When loading thick paper of 106–300 g/m² (28 lb. Bond–110 lb. Cover), follow the recommendations below to prevent misfeeds and loss of image quality.

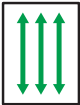
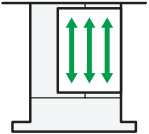
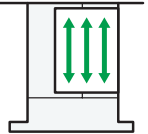
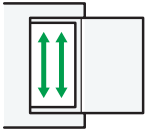
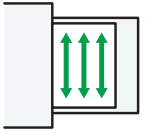
- Store all your paper in the same environment - a room where the temperature is 20–25°C (68–77°F) and the humidity is 30–65%.
- When loading paper in the paper trays, be sure to load at least 20 sheets. Also, be sure to position the side fences flush against the paper stack.
- Jams and misfeeds can occur when printing on thick smooth paper. To prevent such problems, be sure to fan smooth paper thoroughly before loading them. If paper continues to become jammed or feed in together even after they are fanned, load them one by one from the bypass tray.
- When loading thick paper, set the paper direction according to its grain, as shown in the following diagram:

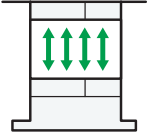
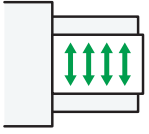
Direction of paper grain	Trays 1–4	Tray 3 (LCT)	Large capacity tray (LCT)	Bypass tray
				
		Not recommended	Not recommended	



Note

- Select [Thick Paper 1], [Thick Paper 2], [Thick Paper 3], or [Thick Paper 4] as the paper thickness in [Tray Paper Settings].
- Even if thick paper is loaded as described above, normal operations and print quality might still not be possible, depending on the paper type.
- Prints might have prominent vertical creases.
- Prints might be noticeably curled. Flatten out prints if they are creased or curled.

Envelopes



This section gives you various details about and recommendations concerning envelopes.

Important

- Do not use window envelopes.
- Misfeeds might occur depending on the length and shape of the flaps.
- Only envelopes that are at least 148 mm (5.9 inches) wide and whose flaps are open can be loaded in the  orientation.
- When loading envelopes in the  orientation, load them with flaps fully open. Otherwise, they might not feed into the machine.
- Before loading envelopes, press down on them to remove any air from inside, flatten out all four edges. If they are bent or curled, flatten their leading edges (the edge going into the machine) by running a pencil or ruler across them.

The way to load envelopes varies depending on the orientation of the envelopes. When printing onto envelopes, load them according to the applicable orientation shown below:

How to load envelopes

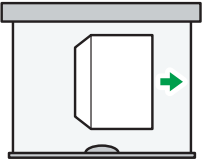
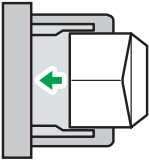
Types of envelopes	Trays 1–4	Bypass tray
Side-opening envelopes  	 <ul style="list-style-type: none"> • Flaps: open • Bottom side of envelopes: toward the right of the machine • Side to be printed: face up 	 <ul style="list-style-type: none"> • Flaps: open • Bottom side of envelopes: toward the left of the machine • Side to be printed: face down

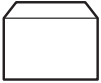
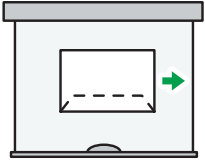
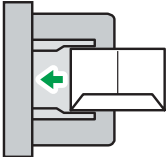
Types of envelopes	Trays 1–4	Bypass tray
<p>Side-opening envelopes </p> 	 <ul style="list-style-type: none"> • Flaps: closed • Bottom side of envelopes: toward the back of the machine • Side to be printed: face up 	 <ul style="list-style-type: none"> • Flaps: closed • Bottom side of envelopes: toward the back of the machine • Side to be printed: face down

When loading envelopes, select "Envelope" as the paper types using both [Tray Paper Settings] and printer driver and specify the thickness of envelopes. For details, see "Printing on Envelopes", Operating Instructions.

To print on envelopes that are loaded with their short edges against the machine body, rotate the print image by 180 degrees using the printer driver.

Recommended envelopes

For information about recommended envelopes, contact your local dealer.

For details about the sizes of envelopes you can load, see page 51 "Recommended Paper Sizes and Types".

Note

- Load only one size and type of envelope at a time.
- The Duplex function cannot be used with envelopes.
- To get better output quality, it is recommended that you set the right, left, top, and bottom print margin, to at least 15 mm (0.6 inches) each.
- Output quality on envelopes may be uneven if parts of an envelope have differing thicknesses. Print one or two envelopes to check print quality.
- Printed sheets are delivered to the internal tray even if you specified a different tray.
- Flatten out prints if they are creased or curled.
- Check the envelopes are not damp.
- High temperature and high humidity conditions can reduce print quality and cause envelopes to become creased.
- Depending on the environment, printing on envelopes may wrinkle them even if they are recommended.

- Certain types of envelopes might come out creased, dirtied, or misprinted. If you are printing a solid color on an envelope, lines may appear where the overlapped edges of the envelope make it thicker.

Printing from the Bypass Tray

★ Important

- If you select [Machine Setting(s)] in [Bypass Tray] under [Tray Setting Priority] in [System] of the Printer Features menu, the settings made using the control panel have priority over the printer driver settings. For details, see "System", Operating Instructions.
- The default of [Bypass Tray] is [Driver / Command].

↓ Note

- Settings remain valid until they are changed.
- When printing from a computer, see "Printing", Operating Instructions.
- The default of [Printer Bypass Paper Size] is [Auto Detect].

Specifying Regular Sizes Using the Control Panel

1. Press [Home] (🏠) at the bottom of the screen in the center.
2. Flick the screen to the left, and then press the [User Tools] icon (⚙️).
3. Press [Tray Paper Settings].
4. Press [Printer Bypass Paper Size].
5. Select the paper size.

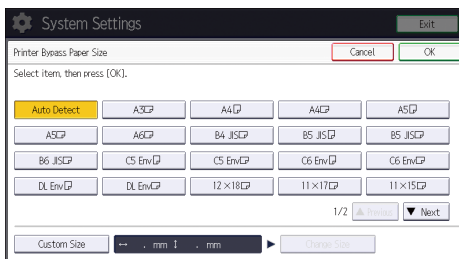

6. Press [OK].
7. Press [User Tools] (⚙️) on the top right of the screen.
8. Press [Home] (🏠) at the bottom of the screen in the center.

Specifying a Custom Size Paper Using the Control Panel

1. Press [Home] (🏠) at the bottom of the screen in the center.
2. Flick the screen to the left, and then press the [User Tools] icon (⚙️) on.
3. Press [Tray Paper Settings].

4. Press [Printer Bypass Paper Size].

5. Press [Custom Size].

If a custom size is already specified, press [Change Size].

6. Press [Horizontal].

7. Enter the horizontal size using the number keys, and then press [#].

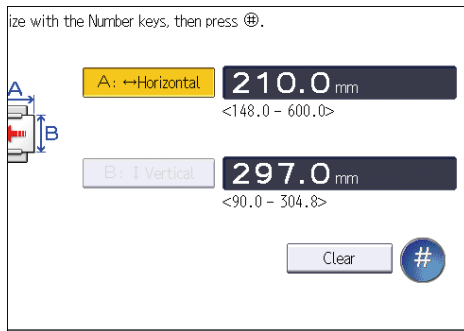

8. Press [Vertical].

9. Enter the vertical size using the number keys, and then press [#].

10. Press [OK] twice.

11. Press [User Tools] (⚙️) on the top right of the screen.

12. Press [Home] (🏠) at the bottom of the screen in the center.

Specifying Thick Paper, Thin Paper, or OHP Transparencies for Paper Type Using the Control Panel

★ Important

- Use A4 or 8¹/₂ × 11 size OHP transparencies, and specify their size.
- Usually only one side of OHP transparencies can be used for printing. Be sure to load them with the print side down.
- When printing onto OHP transparencies, remove printed sheets one by one.

1. Press [Home] (🏠) at the bottom of the screen in the center.

2. Flick the screen to the left, and then press the [User Tools] icon (⚙️).

3. Press [Tray Paper Settings].

4. Press [Printer Bypass Paper Size], and then specify the paper size.

5. Press [OK].

6. Press [▼Next].

7. Press [Paper Type: Bypass Tray].

8. Select the proper items, according to the paper type you want to specify.

- Press [OHP (Transparency)] on the [Paper Type] area when loading OHP transparencies.
- To load thin or thick paper, press [Plain: Hidden] on the [Paper Type] area, and then select the appropriate paper thickness in the [Paper Thickness] area.

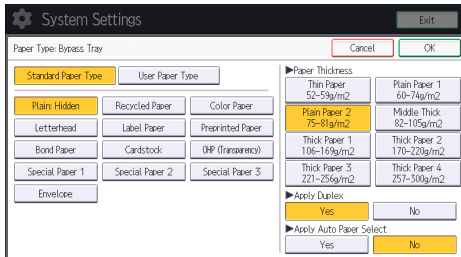

9. Press [OK].

10. Press [User Tools] (⚙️) on the top right of the screen.

11. Press [Home] (🏠) at the bottom of the screen in the center.

Note

- We recommend that you use specified OHP transparencies.
- For details about paper thickness, see "Tray Paper Settings", Operating Instructions.

3. Troubleshooting

This chapter provides solutions to common problems and it also explains how to correct unwanted print results.

When the Machine Makes a Beeping Sound

The following table describes the meaning of the various beep patterns that the machine issues to alert users about left originals and other machine conditions.









Beep pattern	Meaning	Cause
Single short beep	Panel/screen input accepted.	A screen key was pressed.
Short, then long beep	Panel/screen input rejected.	An invalid key was pressed on the screen, or the entered password was incorrect.
2 long beeps	Machine has warmed up.	When the power is turned on or the machine exits Sleep mode, the machine has fully warmed up and is ready for use.
5 long beeps repeated four times	Soft alert	Paper tray is empty.
5 short beeps repeated five times.	Strong alert	The machine requires user attention because paper has jammed, the toner needs replenishing, or other problems have occurred.

Note

- Users cannot mute the machine's beep alerts. When the machine beeps to alert users of a paper jam or toner request, if the machine's covers are opened and closed repeatedly within a short space of time, the beep alert might continue, even after normal status has resumed.
- You can enable or disable beep alerts. For details about Sound, see "DEVICE", Operating Instructions.

When a Status Icon Is Displayed

This section describes the status icons displayed when the machine requires the user to remove misfed paper, to add paper, or to perform other procedures.

Status Icon	Status
 : Paper Misfeed icon	Appears when a paper misfeed occurs. For details about removing jammed paper, see page 92 "Removing Jammed Paper".
 : Load Paper icon	Appears when paper runs out. For details about loading paper, see page 43 "Loading Paper".
 : Add Toner icon	Appears when toner runs out. For details about adding toner, see page 38 "Adding Toner".
 : Add Staple icon	Appears when staples run out. For details about adding staples, see page 40 "Adding Staples".
 : Waste Toner Full icon	Appears when the waste toner bottle is full. For details about replacing the waste toner bottle, see Maintenance Kit SP 8400A.
 : Hole Punch Receptacle Full icon	Appears when the hole punch receptacle is full. For details about removing punch waste, see "Removing Punch Waste", Operating Instructions.
 : Service Call icon	Appears when the machine is malfunctioning or requires maintenance.
 : Open Cover icon	Appears when one or more covers of the machine are open.

When the Indicator Lamp for [Check Status] Is Lit or Flashing

If the indicator lamp for [Check Status] lights up or flashes, press [Check Status] to display the [Check Status] screen. Check the status of each function in the [Check Status] screen.

[Check Status] screen

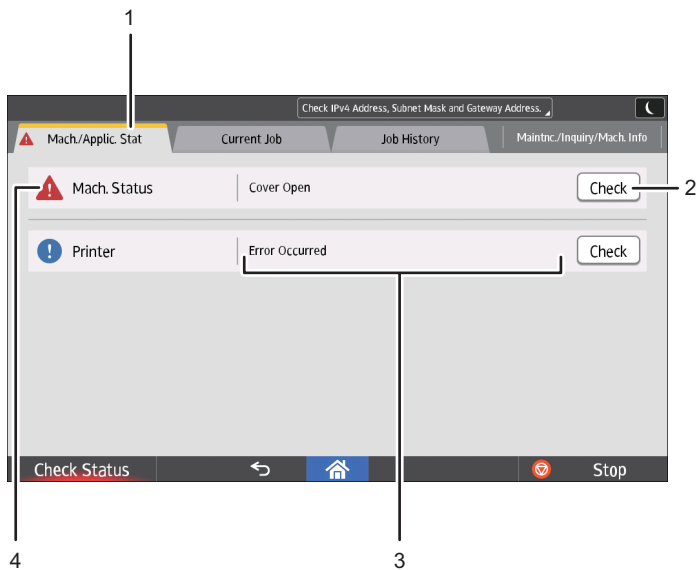

1. [Mach./Applic. Stat] tab

Indicates the status of the machine and each function.

2. [Check]

If an error occurs in the machine or a function, press [Check] to view details.

Pressing [Check] displays an error message or the corresponding function screen. Check the error message displayed on the function screen and take the appropriate action. For details about how to resolve the problems described in error messages, see "When Messages Appear and the Machine Cannot Be Operated", Operating Instructions, page 74 "Messages Displayed When You Use the Printer Function", or page 79 "When Other Messages Appear".

3. Messages

Displays a message that indicates the status of the machine and each function.

4. Status icons

The status icons that can be displayed are described below:

: The function is performing a job.

: The machine cannot be used because an error has occurred in the machine.

: The function cannot be used because an error has occurred in the function or machine. This icon may also appear if the toner is running low.

The following table explains problems that cause the indicator lamp for [Check Status] to light or flash.

Problem	Cause	Solution
Documents and reports do not print out.	The paper output tray is full.	Remove the prints from the tray.
Documents and reports do not print out.	There is no paper left.	Load paper. For details about loading paper, see page 43 "Loading Paper".
An error has occurred.	A function which has the status "Error Occurred" in the [Check Status] screen is defective.	Press [Check] in the function which the error has occurred. Then read the displayed message, and take the appropriate action. For details about error messages and their solutions, see "When Messages Appear and the Machine Cannot Be Operated", Operating Instructions, page 74 "Messages Displayed When You Use the Printer Function", or page 79 "When Other Messages Appear". You can use other functions normally.
The machine is unable to connect to the network.	A network error has occurred.	<ul style="list-style-type: none"> • Check that the machine is correctly connected to the network and that the machine is correctly set. For details about how to connect the network, see "Connecting to the Interface", Operating Instructions. • For details about connecting to the network, contact your administrator. • If the indicator lamp is still lit even after you try to solve the problem as described here, contact your service representative.

When You Have Problems Operating the Machine

Problem	Cause	Solution
The indicator lamp remains lit and the machine does not enter Sleep mode even though [Energy Saver] was pressed.	In some cases, the machine does not enter Sleep mode when [Energy Saver] is pressed.	Before you press [Energy Saver], check that Sleep mode can be enabled. For details about enabling Sleep mode, see "Saving Energy", Operating Instructions.
The display is turned off.	The machine is in Sleep mode.	Touch the display panel or open the front cover or right cover.
Nothing happens when the display panel is touched.	The power is turned off.	Make sure the main power indicator is off, and then turn on the power.
The power turns off automatically.	The Weekly Timer setting is set to [Main Power Off].	Change the Weekly Timer setting. For details about the Weekly Timer setting, see "Timer Settings", Operating Instructions.
The user code entry screen is displayed.	Users are restricted by User Code Authentication.	For details about how to log in when User Code Authentication is enabled, see "When the Authentication Screen is Displayed", Operating Instructions.
The Authentication screen appears.	User Authentication is set.	See "When the Authentication Screen is Displayed", Operating Instructions.
An error message is still displayed, even if misfed paper is removed.	Paper is still jammed in the tray.	Remove the jammed paper by following the procedures displayed on the control panel. For details about removing jammed paper, see page 92 "Removing Jammed Paper".
An error message is still displayed, even if the indicated cover is closed.	One or more of the covers that are not indicated are still open.	Close all the covers of the machine.
Images are printed on the reverse side of the paper.	You may have loaded the paper incorrectly.	Load the paper correctly. For details about loading paper, see page 43 "Loading Paper".

Problem	Cause	Solution
Misfeeds occur frequently.	Using curled paper often causes misfeeds, soiled paper edges, or slipped positions while stack printing is performed.	<ul style="list-style-type: none"> • Flatten the paper with your hands to straighten out the curl. • Load the paper upside down so that the curled edges face downward. For details about recommended paper, see page 51 "Recommended Paper". • Place the cut paper on a flat surface to prevent it from curling, and do not lean it against the wall. For details about the proper way to store paper, see "Paper Storage", Operating Instructions.
Misfeeds occur frequently.	The tray's side or end fences may not be set properly.	<ul style="list-style-type: none"> • Remove the misfed paper. For details about removing jammed paper, see page 92 "Removing Jammed Paper". • Check that the side or end fences are set properly. Also, check that the side fences are locked. For details about setting the side and end fences, see "Changing the Paper Size", Operating Instructions.
Misfeeds occur frequently.	Paper of undetectable size has been loaded.	<ul style="list-style-type: none"> • Remove misfed paper. For details about removing jammed paper, see page 92 "Removing Jammed Paper". • If you load a paper size that is not selected automatically, you need to specify the paper size with the control panel. For details about specifying paper size with the control panel, see "Changing to a Size That Is Not Automatically Detected", Operating Instructions.

Problem	Cause	Solution
Misfeeds occur frequently.	There is a foreign object on the finisher tray.	<ul style="list-style-type: none"> Remove the misfed paper. For details about removing jammed paper, see page 92 "Removing Jammed Paper". Do not place anything on the finisher tray.
Cannot print in duplex mode.	You have selected a paper tray that is not set for duplex printing.	Change the setting for "Apply Duplex" in "Tray Paper Settings" to enable duplex printing for the paper tray. For details about setting "Apply Duplex", see "Tray Paper Settings", Operating Instructions.
Cannot print in duplex mode.	You have selected a paper type that cannot be used for duplex printing.	In "Tray Paper Settings", select a paper type that can be used for duplex printing. For details about setting "Paper Type", see "Tray Paper Settings", Operating Instructions.
The machine does not turn off in 5 minutes after the main power is turned off.	The machine cannot perform the shutdown procedure.	Repeat the shutdown procedure. If the machine does not turn off, contact your service representative.
An error has occurred when the Address Book is changed from the display panel or Web Image Monitor.	The Address Book cannot be changed while you delete the multiple stored documents.	Wait a while, and then retry the operation.
The Address Book cannot be changed from the display panel.	The Address Book cannot be changed while it is being backed up from Web Image Monitor or other tools running on the computer.	<ul style="list-style-type: none"> Wait until the Address Book backup is complete, and then try to change the Address Book again. If an SC997 error occurs, press [Exit].

Problem	Cause	Solution
The function does not run or cannot be used.	The function cannot be performed while the Address Book is being backed up from Web Image Monitor or other tools running on the computer.	Wait a while. When the Address Book backup is complete, the function will be performed.
Paper is bent.	Paper may be bent when it is ejected from the finisher upper tray.	Change the output tray to the finisher shift tray.

Note

- There are times when images might not turn out as you want because of paper type, paper size, or paper capacity problems, use the recommended paper. For details about recommended paper, see page 51 "Recommended Paper Sizes and Types".

If USB Connection Fails

Problem	Cause	Solution
The machine is not automatically recognized.	The USB cable is not connected properly.	Disconnect the USB cable, and turn off the machine, and then turn the machine back on. When the [Home] screen appears, connect the USB cable again.
The machine is not automatically recognized.	Windows has already configured the USB settings.	Check whether the computer has identified the machine as an unsupported device. Open Windows' Device Manager, and then, under [Universal Serial Bus controllers], remove any conflicting devices. Conflicting devices are indicated by a [!] or [?] icon. Be careful not to remove required devices accidentally. For details, see Windows Help.
The machine does not recognize the USB connection even when a USB cable is inserted.	If the USB cable is connected while the machine is off, the machine might not recognize the USB connection.	Press [Check Status], and then disconnect the USB cable. After you disconnect cable, press [Check Status] again. When the machine is ready, connect the USB cable again.

Messages Displayed When You Use the Printer Function

This section describes the principal messages that appear on the display panel, error logs or reports. If other messages appear, follow their instructions.

Messages Displayed on the Control Panel When You Use the Printer Function

3

★ Important

- Before turning off the power, see page 30 "Turning On/Off the Power".

Message	Cause	Solution
"Hardware Problem: Ethernet"	An error has occurred in the Ethernet interface.	Turn off the power, and then back on again. If the message appears again, contact your service representative.
"Hardware Problem: HDD"	An error has occurred in the hard disk.	Turn off the power, and then back on again. If the message appears again, contact your service representative.
"Hardware Problem: USB"	An error has occurred in the USB interface.	Turn off the power, and then back on again. If the message appears again, contact your service representative.
"Hardware Problem: Wireless Card" (A "wireless LAN board" is referred to as a "wireless card".)	<ul style="list-style-type: none"> • The wireless LAN board has malfunctioned. • The wireless LAN board you are using is not compatible with this machine. 	Turn off the power, and then confirm the wireless LAN board is inserted correctly. And then, turn on the power again. If the message appears again, contact your service representative.

Message	Cause	Solution
"Load following paper in n. To force print, select another tray and press [Continue]." (<i>"n"</i> is replaced by a variable.)	The printer driver settings are incorrect or the tray does not contain paper of the size selected in the printer driver.	Check that the printer driver settings are correct, and then load paper of the size selected in the printer driver into the input tray. For details about how to change the paper size, see "Changing the Paper Size", Operating Instructions.
"Paper in staple tray. Open cover and remove paper."	If printing is stopped before it is finished, paper may remain in the finisher.	Remove the paper remaining in the finisher.
"Paper size and type are mismatched. Select another tray from the following and press [Continue]. To cancel job, press [Job Reset]. Paper size and type can also be changed in User Tools."	The printer driver settings are incorrect or the tray does not contain paper of the size or type selected in the printer driver.	<ul style="list-style-type: none"> • Check that the printer driver settings are correct, and then load paper of the size selected in the printer driver into the input tray. For details about how to change the paper size, see "Changing the Paper Size", Operating Instructions. • Select the tray manually to continue printing, or cancel a print job. For details about how to select the tray manually, or cancel a print job, see "If an Error Occurs with the Specified Paper Size and Type", Operating Instructions.
"Paper type of n is mismatched. Select another tray from the following and press [Continue]. Paper type can also be changed in User Tools." (A tray name is placed at n.)	The type of the paper in the tray does not match the paper type specified in the printer driver.	Select a tray containing paper that is the same type as the specified paper type.

Message	Cause	Solution
"Parallel I/F board has a problem."	An error has occurred in the IEEE 1284 interface board.	Turn off the power, and then back on again. If the message appears again, contact your service representative.
"Printer font error."	An error has occurred in the font settings.	Contact your service representative.
"Cannot print because both the main and designation (chapter) sheets are set to the same paper tray. Press [Job Reset] to cancel the job. To print the job again specify different trays."	The tray selected for other pages is the same as the one for slip sheets.	Reset the job. Be sure the tray you select for slip sheets is not providing paper for other pages.

When using direct print from a memory storage device

Message	Cause	Solution
"Exceeded the limit value for total data size of the selected files. Cannot select more files."	<ul style="list-style-type: none"> The size of the selected file exceeds 1 GB. The total size of the selected files exceeds 1 GB. 	<p>Files or groups of files larger than 1 GB cannot be printed.</p> <ul style="list-style-type: none"> When the total size of the multiple files that are selected exceeds 1 GB, select files separately. When the size of the selected file exceeds 1 GB, print from a memory storage device using a function other than the Direct printing function. <p>You cannot select files of different formats at the same time.</p>

Message	Cause	Solution
"Unable to access the specified memory storage device."	<ul style="list-style-type: none"> An error occurred when the machine accessed the memory storage device or a file stored on the memory storage device. An error occurred when the user used the Direct printing function to print from a memory storage device. 	Save the file to a different memory storage device, and then print again.

Messages Printed on the Error Logs or Reports When You Use the Printer Function

This section describes likely causes of and possible solutions for the error messages that are printed on the error logs or reports.

When print jobs are canceled

Message	Cause	Solution
"91: Error"	Printing was canceled by the auto job cancel function due to a command error.	Check that the data is valid.
"A job via the network that was not printed exists because an error occurred. It was stored as a job not printed."	Jobs with errors were stored because an error occurred with a print job via the network while the error job storing function was enabled.	Contact your administrator to check whether the machine is connected correctly to the network. For details about how to check and print jobs stored when print configuration errors occur, see "Printing of Documents Stored When Print Configuration Errors Occur", Operating Instructions.

Message	Cause	Solution
"Error occurred while processing an Unauthorized Copy Prevention job. Job cancelled."	The [Enter User Text:] field on the [Unauthorized Copy Prevention for Pattern Details] screen is blank.	On the printer driver's [Detailed Settings] tab, click [Effects] in "Menu:". Select [Unauthorized Copy Prevention], and then click [Details...] to display [Unauthorized Copy Prevention for Pattern Details]. Enter text in [Enter User Text:].
"Error occurred while processing an Unauthorized Copy Prevention job. Job cancelled."	The resolution is set to a value less than 600 dpi when [Unauthorized Copy Prevention] is specified.	On the printer driver, set the resolution to 600 dpi or higher, or cancel [Unauthorized Copy Prevention].
"Error occurred while processing an Unauthorized Copy Prevention job. Job cancelled."	In [Administrator Tools] under [System Settings], priority was specified to be given to Unauthorized Copy Prevention Printing set on this machine.	Cancel Unauthorized Copy Prevention Printing for the printer driver. For details about how to cancel the settings, see the printer driver Help.
"Collate Cancelled"	Collate was canceled.	Turn off the power, and then back on again. If the message appears again, contact your service representative.
"You reach the usage limit. This job has been cancelled."	The number of pages the user is permitted to print has been exceeded.	For details about print volume use limitation, see "Managing Print Volume per User", Security Guide.
"Receiving data failed."	Data reception was aborted.	Resend the data.
"Sending data failed."	The machine received a command to stop transmission from the printer driver.	Check if the computer is working correctly.
"The selected paper size is not supported. This job has been cancelled."	Job reset is automatically performed if the specified paper size is incorrect.	Specify the correct paper size, and then print the file again.
"The selected paper type is not supported. This job has been cancelled."	Job reset is automatically performed if the specified paper type is incorrect.	Specify the correct paper type, and then print the file again.

When Other Messages Appear

Message	Cause	Solution
"Firmware update will start. Press [OK]. It will start automatically after 30 seconds have elapsed."	Automatic firmware update is enabled and it is the time for an automatic update.	<ul style="list-style-type: none"> • If you want to start the firmware update, press [OK], or configure the setting so that the automatic firmware update starts automatically in 30 seconds. • If you do not want to start the firmware update, press [Cancel] before 30 seconds elapse. • Do not turn off the power switch during the firmware update.
"Cannot connect with the wireless card. Turn the main power switch off, then check the card." (A "wireless LAN board" is referred to as a "wireless card".)	<ul style="list-style-type: none"> • The wireless LAN board was not inserted when the machine was turned on. • The wireless LAN board was pulled out after the machine was turned on. <p>The settings are not updated although the unit is detected.</p>	Turn off the power, and then check the wireless LAN board is inserted correctly. After this, turn on the power again. If the message appears again, contact your service representative.
"Failed to read the PDF file."	There is a possibility that the PDF version is not supported by the browser's PDF viewer or an unsupported encryption level is specified.	<p>With this machine's browser PDF files other than those whose versions and encryption levels are specified below cannot be viewed.</p> <ul style="list-style-type: none"> • PDF version: 1.3-1.7 • PDF encryption level: 128Bit AES or 256Bit AES
"Following output tray is full. Remove paper."	The output tray is full.	Remove paper from the output tray to resume printing. Press [Continue] on the display panel to resume printing.

Message	Cause	Solution
"Internal cooling fan is active."	Large print runs will cause the machine's interior to heat up, triggering the cooling fan.	The fan will emit noise, but this is normal and the machine will be operable while the fan is running. The amount of paper that can be printed and the total operation time until the fan starts running depends on the temperature of the location at which the machine is installed.
"Self checking..."	The machine is performing image adjustment operations.	The machine may perform periodic maintenance during operations. The frequency and duration of maintenance depends on the humidity, temperature, and printing factors such as number of prints, paper size, and paper type. Wait for the machine to resume operation.

When Problems Occur While Logging In

Message	Cause	Solution
"Authentication has failed."	The entered login user name or login password is not correct.	For details about the correct login user name and login password, see "Basic Authentication", Security Guide.
"Authentication has failed."	The machine cannot perform authentication.	For details about authentication, see "Configuring User Authentication", Security Guide.

When the User Lacks Privileges to Perform an Operation

Message	Cause	Solution
"You do not have the privileges to use this function."	The logged in user name does not have permissions for the selected function.	For details about how to set permissions, see "Limiting Available Functions", Security Guide.

When You Cannot Print

Cause	Solution
The power is off.	For details about how to turn on the power, see page 30 "Turning On/Off the Power".
The cause is displayed on the screen of the control panel.	Check the error message or warning status on the display panel, and then take the required action. For details about solutions, see page 74 "Messages Displayed When You Use the Printer Function".
The interface cable is not connected correctly.	For details about how to connect interface cables correctly, see "Connecting to the Interface", Operating Instructions.
The correct interface cable is not being used.	The type of interface cable you use depends on the computer. Be sure to use the correct one. If the cable is damaged or worn, replace it. For details about the interface cable, see "Connecting to the Interface", Operating Instructions.
The interface cable was connected after the power was turned on.	Connect the interface cable before turning on the power.
If the machine is using wireless LAN, a weak wireless signal might result in print failures.	<p>Check the radio signal status of the wireless LAN in [System Settings]. If signal strength is not satisfactory, move the machine to a location where radio waves travel, or remove objects that might cause interference.</p> <p>You can check signal status only when wireless LAN is used in infrastructure mode. For details about the radio signal status of the wireless LAN, see "Interface Settings", Operating Instructions.</p>
If the machine is using a wireless LAN (IEEE 802.11b/g/n), radio waves may be interfering with wireless communication. This may occur if there is a microwave oven, cordless telephone, industrial machine, scientific instrument, or medical instrument using the same frequency range near the device.	Turn off other machines or instruments which use the same frequency range, and then print again. If printing is successful after you turn off the power, then it is possible these devices are the cause of the interference. Move the devices to a location where they do not interfere.

Cause	Solution
If the machine is using wireless LAN, SSID settings are incorrect.	Check that the SSID is correctly set by using the machine's display panel. For details about SSID setting, see "Wireless LAN", Operating Instructions.
If the machine is using wireless LAN, the receiver's MAC address may be preventing communication with the access point.	Check access point settings when wireless LAN is used in the infrastructure mode. Depending on the access point, client access may be limited by MAC address. Also, check there are no transmission problems between access point and wired clients, and between access point and wireless clients.
The login user name, login password, or driver encryption key is invalid.	Check the login user name, login password, or driver encryption key.
Advanced encryption has been set using the extended security function.	Check the extended security function settings. For details about extended security function settings, see "Specifying the Extended Security Functions", Security Guide.
A mechanical error might have occurred.	Contact your service representative.
Transmission mode is not configured correctly when wireless LAN is used in ad hoc mode.	<ul style="list-style-type: none"> • Turn off the power, and then turn it on again. For details about how to turn on and off the power, see page 30 "Turning On/Off the Power". • Change [Communication Mode] in [System Settings] to [802.11 Ad-hoc Mode], and then select [Off] for [Security Method]. For details about Communication Mode, see "Interface Settings", Operating Instructions.
When the Data In indicator does not light up or flash after a print job starts, data is not being sent to the machine.	<ul style="list-style-type: none"> • When a cable is used to connect the computer directly to the machine, check whether the print ports are configured correctly. • When the computer is connected to the network, ask your administrator about the computer's network connection.

If printing does not start, contact your service representative.

Other Printing Problems

This section describes likely causes of and possible solutions for problems that can occur when printing from a computer.

When you cannot print clearly

Problem	Cause	Solution
The printed image is smudged.	Settings for thick paper have not been made for printing on thick paper in the bypass tray.	<p>PCL 5e</p> <p>On the printer driver's [Paper] tab, select [Bypass Tray] in the "Input Tray:" list. Then in the "Type:" list, select a proper paper type.</p> <p>PCL 6 or PostScript 3</p> <p>On the printer driver's [Detailed Settings] tab, click [Paper] in "Menu:", and then select [Bypass Tray] in the "Input Tray:" list. Then in the "Paper Type:" list, select a proper paper type.</p>
The printed image is faded over the entire page.	The paper is damp.	Use paper that has been stored in the recommended temperature and humidity conditions. For details about the paper storage conditions we recommend, see "Paper Storage", Operating Instructions.
The printed image is faded over the entire page.	The paper is unsuitable.	Use recommended paper. Printing on coarse or treated paper might result in faint print image. For details about recommended paper, see page 51 "Recommended Paper Sizes and Types".
The printed image is faded over the entire page.	If the [Toner Saving] is selected in the printer driver settings, the entire page will be faded when printed.	<p>Only when using PostScript 3</p> <p>On the printer driver's [Detailed Settings] tab, click [Print Quality:Standard] in "Menu:", and then select [Off] in the "Toner Saving:" list.</p>

Problem	Cause	Solution
Images smudge when rubbed. (Toner is not fixed.)	The specified paper type and the paper that is actually loaded might be different. For example, thick paper might be loaded but not specified as the paper type.	<p>PCL 5e</p> <p>On the printer driver's [Paper] tab, select a proper paper type in the [Type:] box.</p> <p>PCL 6 or PostScript 3</p> <p>On the printer driver's [Detailed Settings] tab, click [Paper] in "Menu:", and then select a proper paper type in the "Paper Type:" list.</p>
The printed image is different from the image on the computer's display.	Printing will be performed by the machine's graphic processing function.	<p>Only when using PCL 6</p> <p>On the printer driver's [Detailed Settings] tab, click [Print Quality:Advanced] in "Menu:", and then select [Raster] in the "Vector/Raster:" list.</p>
When graphics are printed, the output and the screen are different.	If the printer driver is configured to use the graphics command, the graphics command from the machine is used to print.	If you want to print accurately, set the printer driver to print without using the graphics command. For details about settings for printer driver, see the printer driver Help.
Lines of garbled or unwanted alphanumeric characters appear.	An incorrect printer language might have been selected.	Select the correct printer driver, and then print the file again.
Images are cut off, or margins are printed.	You may be using paper smaller than the size selected in the application.	Use the same size paper as that selected in the application. If you cannot load paper of the correct size, use the reduction function to reduce the image, and then print. For details about reduction function, see the printer driver Help.
Photo images are coarse.	Some applications print at lower resolution.	Use the application's settings or printer driver's settings to specify a higher resolution. For details about printer driver's settings, see the printer driver Help.

Problem	Cause	Solution
A solid line is printed as a dashed line or appears blurred.	Dither patterns do not match.	Change the dithering settings on the printer driver. For details about the dithering settings, see the printer driver Help.
Fine or inconsistently thick lines appear, or fine lines do not appear.	Extremely fine lines have been specified.	<p>Change the dithering settings on the printer driver. For details about the dithering settings, see the printer driver Help.</p> <p>If the problem continues after you change the dithering settings, use the settings of the application in which the image was created to change the thickness of the lines.</p>
Images appear only partially.	The paper is damp.	Use paper that has been stored in the recommended temperature and humidity condition. For details about the paper storage conditions we recommend, see "Paper Storage", Operating Instructions.
The image on the back side of duplex copies has mottled blank patches or is smudged.	Missing patches and smudges are caused by moisture leaking from the paper.	<ul style="list-style-type: none"> • Do not install the machine in low-temperature areas. • Use paper that has been stored where temperature and humidity conditions meet the conditions we recommend. For details about the paper storage conditions we recommend, see "Paper Storage", Operating Instructions. • Install the Optional anti-humidity heater. For details about the anti-humidity heater, contact your service representative.

When paper is not fed properly

Problem	Cause	Solution
Paper is not fed from the selected tray.	When you are using a Windows operating system, printer driver settings override those settings applied to the display panel.	<p>PCL 5e</p> <p>On the printer driver's [Paper] tab, select the desired input tray in the "Input Tray:" list.</p> <p>PCL 6 or PostScript 3</p> <p>On the Printer driver's [Detailed Settings] tab, click [Paper] in "Menu:", select the input tray you want to use in the "Input Tray:" list.</p>
Images are printed at a slant.	The tray's side fences might not be locked.	Check that the side fences are locked. For details about how to set the side fences, see "Changing the Paper Size", Operating Instructions.
Images are printed at a slant.	The paper is fed in at a slant.	Load the paper correctly. For details about loading paper, see page 43 "Loading Paper".
Misfeeds occur frequently.	The number of sheets loaded exceeds the capacity of the machine.	Load paper only as high as the upper limit markings on the side fences of the paper tray, or the markings on the paper guides of the bypass tray.
Misfeeds occur frequently.	The paper tray's side fences are set too tightly.	Push the side fences lightly, and then reset them.
Misfeeds occur frequently.	The paper is damp.	Use paper that has been stored in the recommended temperature and humidity conditions. For details about the paper storage conditions we recommend, see "Paper Storage", Operating Instructions.
Misfeeds occur frequently.	The paper is too thick or thin.	Use recommended paper. For details about recommended paper, see page 51 "Recommended Paper Sizes and Types".

Problem	Cause	Solution
Misfeeds occur frequently.	The paper is wrinkled or has been folded or creased.	<ul style="list-style-type: none"> Use recommended paper. For details about recommended paper, see page 51 "Recommended Paper Sizes and Types". Use paper that has been stored in the recommended temperature and humidity conditions. For details about the proper way to store paper, see "Paper Storage", Operating Instructions.
Misfeeds occur frequently.	Printed paper is being used.	Do not load sheets that have already been copied or printed.
Misfeeds occur frequently.	Sheets are sticking together.	Fan the sheets thoroughly before loading them. Alternatively, feed the sheets into the machine one at a time.
Sheets are fed in together, resulting in jams.	Sheets are sticking together.	Fan the sheets thoroughly before loading them. Alternatively, feed the sheets into the machine one at a time.
Printed paper becomes creased.	The paper is damp.	Use paper that has been stored in the recommended temperature and humidity conditions. For details about the paper storage conditions we recommend, see "Paper Storage", Operating Instructions.
Printed paper becomes creased.	The paper is too thin.	Use recommended paper. For details about recommended paper, see page 51 "Recommended Paper Sizes and Types".
Edges of sheets are creased.	The paper is damp.	Use paper that has been stored in the recommended temperature and humidity conditions. For details about the paper storage conditions we recommend, see "Paper Storage", Operating Instructions.

Problem	Cause	Solution
Edges of sheets are creased.	You are using non-recommended paper.	Use recommended paper. For details about recommended paper, see page 51 "Recommended Paper Sizes and Types".
Duplex printing cannot be applied.	You have loaded paper that is too thick or thin.	Change the paper. For details about paper weight that can be used for duplex printing, see "Specifications for the Main Unit", Operating Instructions.
Duplex printing cannot be applied.	You have selected a paper tray that is not set for duplex printing.	Change the setting for "Apply Duplex" in "Tray Paper Settings" to enable duplex printing for the paper tray. For details about setting "Apply Duplex", see "Tray Paper Settings", Operating Instructions.
Duplex printing cannot be applied.	You have selected a paper type that cannot be used for duplex printing.	In "Tray Paper Settings", select a paper type that can be used for duplex printing. For details about setting "Paper Type", see "Tray Paper Settings", Operating Instructions.
White stripes appear on the OHP transparency.	Fragments of paper are stuck to the OHP transparency.	Use a dry cloth to wipe any paper fragments off the back of the OHP transparency.

Other printing problems

Problem	Cause	Solution
It takes a long time to complete a print job.	Sleep mode or Fusing Unit Off mode might be set.	The machine requires time to warm up if it has been in Sleep mode or Fusing Unit Off mode. For details about Sleep mode and Fusing Unit Off mode, see page 31 "Saving Energy".

Problem	Cause	Solution
It takes a long time to complete a print job.	Photographs and other data-intensive pages take a long time for the machine to process. Wait until printing is complete.	If the Data In indicator is flashing, the printer has received data. Wait for a moment. Specifying a lower resolution with the printer driver may help speed up printing. For details about how to change the resolution setting, see the printer driver Help.
When printing is performed using the USB device server, a print job cannot be completed properly.	Even if the USB device server has received the data successfully, the machine cannot complete the print job properly because the timeout period set on the machine is too short.	Specify a longer period for [I/O Timeout] in [System] under [Printer Features]. For details about I/O Timeout, see "System", Operating Instructions.
Images are printed in the wrong orientation.	The feed orientation you selected and the feed orientation selected in the printer driver's option setup might be different.	Make sure the machine's feed orientation and the printer driver's feed orientation match. For details about printer driver settings, see the printer driver Help.
Optional components connected to the machine are not recognized.	Bidirectional communication is not working.	Set up optional devices on the Properties of the printer. For details about how to set up optional devices, see the printer driver Help.
Combined printing or Auto Reduce/Enlarge printing does not work as expected.	The correct application or printer driver settings are not configured.	Make sure the application's paper size and orientation settings match those of the printer driver. If a different paper size and orientation are set, select the same size and orientation.
A print instruction was issued from the computer, but printing did not start.	User Authentication may have been set.	For details about user authentication, see "Configuring User Authentication", Security Guide.
The paper bound by staple-free stapling comes apart.	An image is printed in the stapling position.	Adjust the position of the image on the original so that it is not printed in the stapling position.

Problem	Cause	Solution
PDF files cannot print or PDF direct printing cannot be performed.	PDF files are password-protected.	To print password-protected PDF files, enter the password in the [PDF Menu] or on Web Image Monitor. For details about printing PDF files, see "PDF Menu", Operating Instructions or Web Image Monitor Help.
PDF files cannot print or PDF direct printing cannot be performed.	PDF files cannot print if they are print-disabled in PDF file security setting.	Change the PDF file security setting.
PDF direct print produces garbled characters.	Fonts were not embedded.	Embed fonts in the PDF file you want to print, and then print.
Printing did not start even though the specified print time passed.	[Jobs Not Printed As Machn. Was Off] was set to [Do not Print] in [Printer Features], but when the specified printing time came, the power was turned off.	Set [Jobs Not Printed As Machn. Was Off] to [Print When Machine On] in [Printer Features].
Printing did not start even though the specified print time passed.	The time set on the machine or computer is incorrect.	Set the correct time on the machine or computer.
It takes a long time to start printing.	The machine accesses the USB interface when it receives a print job from the USB device server's network. In this case, it takes longer than usual to start a print job received from the machine's network.	Specify a shorter period for [I/O Timeout] in [System] under [Printer Features]. For details about I/O Timeout, see "System", Operating Instructions.
A print process using wireless LAN is slow.	The number of jobs exceeds the capacity of the machine.	Reduce the number of jobs.

Problem	Cause	Solution
A print process using wireless LAN is slow.	<ul style="list-style-type: none"> • A communication error might have occurred. • Interference from other wireless LAN devices can reduce data transmission speed. • If the machine is using a wireless LAN (IEEE 802.11b/g/n), radio waves may be interfering with the wireless communication. This may occur if a microwave oven, cordless telephone, industrial machine, scientific instrument, or medical instrument using the same frequency range is placed near the device. 	<ul style="list-style-type: none"> • Move the machine away from the wireless LAN device. • If there are active wireless LAN devices nearby, move the machine or disable those devices. • Turn off other machines or devices which use the same frequency range, and then print again to check whether the devices cause interference. If printing is successful after you turn off the power, then it is possible these devices are the cause of the interference. Move the devices to a location where they do not interfere.

If the problem cannot be resolved, contact your service representative.

Removing Jammed Paper

CAUTION

- The inside of the machine could be very hot. Do not touch the parts with a label indicating the "hot surface." Otherwise, an injury might occur.
- Some of this machine's internal components get very hot. For this reason, take care when removing misfed paper. Not doing so could result in burns.
- When removing jammed paper, make sure not to trap or injure your fingers.

Important

- To prevent misfeeds, do not leave any torn scraps of paper inside the machine.
- If paper jams continue to occur, see page 69 "When You Have Problems Operating the Machine" and page 83 "Other Printing Problems" for details about how to solve the problem. If the actions recommended in this manual fail to eliminate the problem, contact your service representative.
- If the error message remains displayed even after you remove misfed paper, fully open the front cover, and then close it.
- When removing jammed paper, you can touch only those areas explicitly indicated in the manual.
- Do not remove the fusing unit. Doing so will result in loss of print quality.
- To remove paper that has not been fed into the fixing section correctly, remove the jammed paper through the underside of the fusing unit. If the jammed paper cannot be removed through the underside of the fusing unit, remove it from the top.
- When clearing paper jams from the mailbox, open the right cover all the way and hold it with your hand. Releasing the right cover while it is open may damage the band that holds the right cover.

Note

- Inside the finisher, or inside the front cover, there are stickers or sheets explaining how to remove misfed paper.
- If a detailed removal instruction appears on the right of the screen, follow it.
- You can also use the procedure indicated in the [Check Status] screen to remove jammed paper.

Locating Jammed Paper

If a misfeed occurs, remove the jammed paper by following the procedures indicated in the animation that appears on the screen and the sticker or sheet inside the front cover.

A misfeed has occurred in the place corresponding to the letter displayed on the control panel.

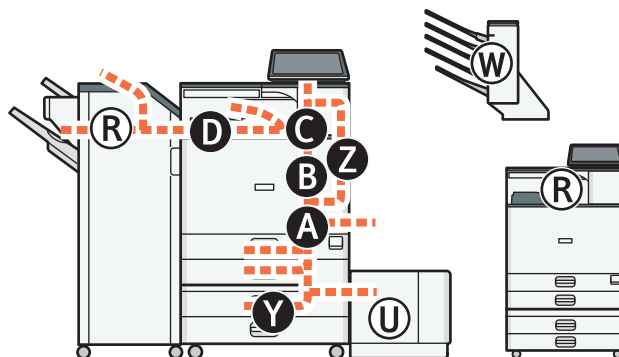

DUL208

1. Remove the jammed paper by following the procedures that are displayed on the screen.

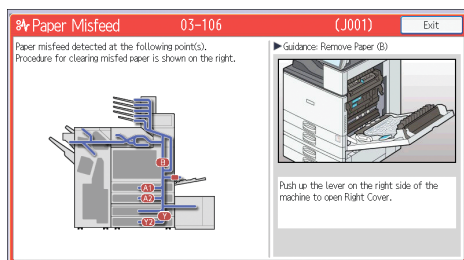

- When [Next] or [Previous] is displayed on the screen.

After each step is complete, press [Next]. To go back to the previous step, press [Previous].

2. When the jammed paper is removed, restore the machine to the original state.

Note

- Multiple paper misfeed locations may be indicated at the same time. When this happens, check all the areas indicated.
- If there is no misfed paper in the area you check first, see the other areas that are indicated.

4. Information for This Printer

This chapter describes environmental precautions and regulations.

Information on Environmental Regulations

ENERGY STAR Program

ENERGY STAR® Program Requirements for Imaging Equipment



This company is a participant in the ENERGY STAR® Program.

This machine is compliant with the regulations specified by the ENERGY STAR® Program.

4

The ENERGY STAR® Program Requirements for Imaging Equipment encourage energy conservation by promoting energy efficient computers and other office equipment.

The program backs the development and dissemination of products that feature energy saving functions.

It is an open program in which manufacturers participate voluntarily.

Targeted products are computers, monitors, printers, facsimiles, copiers, scanners, and multi-function devices. Energy Star standards and logos are internationally uniform.

↓ Note

- For details about the "default delay time", see page 95 "Energy Saving Functions".

Energy Saving Functions

To reduce its power consumption, this machine has the following functions:

Sleep mode

- If this machine remains idle for a specified period or when [Energy Saver] () is pressed, it enters Sleep mode to further reduce its electrical consumption.

- The default delay time the machine waits before entering Sleep mode is 1 minute. This default time can be changed.
- The machine can print jobs from computers while in Sleep mode.

Specification

-  **Region A** (mainly Europe and Asia)

	Specification
Reduced electrical consumption in Sleep mode ^{*1}	0.89 W
Time of switch into Sleep mode	1 minute
Time of switch out from Sleep mode ^{*1}	7 seconds
Duplex Function ^{*2}	Standard

*1 The time it takes to switch out from energy saving functions and electrical consumption may differ depending on the conditions and environment of the machine.

*2 Achieves ENERGY STAR energy savings; product fully qualifies when packaged with (or used with) a duplex tray and the duplex function is enabled as an option.

-  **Region B** (mainly North America)

	Specification
Reduced electrical consumption in Sleep mode ^{*1}	0.79 W
Time of switch into Sleep mode	1 minute
Time of switch out from Sleep mode ^{*1}	7 seconds
Duplex Function ^{*2}	Standard

*1 The time it takes to switch out from energy saving functions and electrical consumption may differ depending on the conditions and environment of the machine.

*2 Achieves ENERGY STAR energy savings; product fully qualifies when packaged with (or used with) a duplex tray and the duplex function is enabled as an option.

 **Note**

- Specifications can vary depending on which options are installed on the machine.
- For details about how to change the default interval, see "Timer Settings", Operating Instructions.

- Depending on which embedded software application is installed on it, the machine might take longer than indicated to enter Sleep mode.

User Information on Electrical and Electronic Equipment Region A (mainly Europe)

Users in the countries where this symbol shown in this section has been specified in national law on collection and treatment of E-waste

Our Products contain high quality components and are designed to facilitate recycling.

Our products or product packaging are marked with the symbol below.



The symbol indicates that the product must not be treated as municipal waste. It must be disposed of separately via the appropriate return and collection systems available. By following these instructions you ensure that this product is treated correctly and help to reduce potential impacts on the environment and human health, which could otherwise result from inappropriate handling. Recycling of products helps to conserve natural resources and protect the environment.

For more detailed information on collection and recycling systems for this product, please contact the shop where you purchased it, your local dealer or sales/service representatives.

All Other Users

If you wish to discard this product, please contact your local authorities, the shop where you bought this product, your local dealer or sales/service representatives.

For Turkey only

AEEE Yönetmeliğine Uygundur.

Bu sistem sarf malzemeleri ve yedek parçaları da dahil olmak üzere AEEE Yönetmeliğine Uygundur.

Üretici:

Ricoh Company, Ltd.

3-6, Nakamagome 1-chome,
Ohta-ku, Tokyo 143-8555 Japan

+81-3-3777-8111(English only/Sadece İngilizce)

Note for the Battery and/or Accumulator Symbol (For EU countries only)

 **Region A (mainly Europe)**

4



In accordance with the Battery Directive 2006/66/EC Article 20 Information for end-users Annex II, the above symbol is printed on batteries and accumulators.

This symbol means that in the European Union, used batteries and accumulators should be disposed of separately from your household waste.

In the EU, there are separate collection systems for not only used electrical and electronic products but also batteries and accumulators.

Please dispose of them correctly at your local community waste collection/recycling centre.

Contact your sales or service representative to change the battery.

Environmental Advice for Users **Region A (mainly Europe)**

Users in the EU, Switzerland and Norway

Consumables yield

Please refer to either the User's Manual for this information or the packaging of the consumable.

Recycled paper

The machine can use recycled paper which is produced in accordance with European standard EN 12281:2002 or DIN 19309. For products using EP printing technology, the machine can print on 64 g/m² paper, which contains less raw materials and represents a significant resource reduction.

Duplex printing (if applicable)

Duplex printing enables both sides of a sheet of paper to be used. This saves paper and reduces the size of printed documents so that fewer sheets are used. We recommend that this feature is enabled whenever you print.

Toner and ink cartridge return program

Toner and ink cartridge for recycling will be accepted free of charge from users in accordance with local regulations.

For details about the return program, please refer to the Web page below or consult your service person.

<https://www.ricoh-return.com/>

Energy efficiency

The amount of electricity a machine consumes depends as much on its specifications as it does on the way you use it. The machine is designed to allow you to reduce electricity costs by switching to Ready mode after it prints the last page. If required, it can immediately print again from this mode. If no additional prints are required and a specified period of time passes, the device switches to an energy saving mode.

In these modes, the machine consumes less power (watts). If the machine is to print again, it needs a little longer to return from an energy saving mode than from Ready mode.

For maximum energy savings, we recommend that the default setting for power management is used.

Products that comply with the Energy Star requirement are always energy efficient.

Notes to users in the state of California (Notes to Users in USA) Region B (mainly North America)

Perchlorate Material - special handling may apply. See: www.dtsc.ca.gov/hazardouswaste/perchlorate

Trademarks

Adobe, PostScript, and PostScript 3 are either registered trademarks or trademarks of Adobe Systems Incorporated in the United States and/or other countries.

Firefox is a registered trademark of the Mozilla Foundation.

Google and Chrome are trademarks of Google Inc.

JAWS® is a registered trademark of Freedom Scientific, Inc., St. Petersburg, Florida and/or other countries.

OS X and Safari are trademarks of Apple Inc., registered in the U.S. and other countries.

Microsoft, Windows, Windows Server, Windows Vista, Internet Explorer, and Microsoft Edge are either registered trademarks or trademarks of Microsoft Corp. in the United States and/or other countries.

The SD and SD logo are trademarks of SD-3C, LLC.

4



This product includes RSA BSAFE® Cryptographic software of EMC Corporation. RSA and BSAFE are registered trademarks or trademarks of EMC Corporation in the United States and other countries.

The proper names of Internet Explorer 7 and 8 are as follows:

- Windows® Internet Explorer® 7
- Windows® Internet Explorer® 8

The proper names of the Windows operating systems are as follows:

- The product names of Windows Vista are as follows:

Microsoft® Windows Vista® Ultimate

Microsoft® Windows Vista® Business

Microsoft® Windows Vista® Home Premium

Microsoft® Windows Vista® Home Basic

Microsoft® Windows Vista® Enterprise

- The product names of Windows 7 are as follows:

Microsoft® Windows® 7 Home Premium

Microsoft® Windows® 7 Professional

Microsoft® Windows® 7 Ultimate

Microsoft® Windows® 7 Enterprise

- The product names of Windows 8.1 are as follows:
 - Microsoft® Windows® 8.1
 - Microsoft® Windows® 8.1 Pro
 - Microsoft® Windows® 8.1 Enterprise
- The product names of Windows 10 are as follows:
 - Microsoft® Windows® 10 Home Premium
 - Microsoft® Windows® 10 Pro
 - Microsoft® Windows® 10 Enterprise
 - Microsoft® Windows® 10 Education
- The product names of Windows Server 2008 are as follows:
 - Microsoft® Windows Server® 2008 Standard
 - Microsoft® Windows Server® 2008 Enterprise
- The product names of Windows Server 2008 R2 are as follows:
 - Microsoft® Windows Server® 2008 R2 Standard
 - Microsoft® Windows Server® 2008 R2 Enterprise
- The product names of Windows Server 2012 are as follows:
 - Microsoft® Windows Server® 2012 Foundation
 - Microsoft® Windows Server® 2012 Essentials
 - Microsoft® Windows Server® 2012 Standard
- The product names of Windows Server 2012 R2 are as follows:
 - Microsoft® Windows Server® 2012 R2 Foundation
 - Microsoft® Windows Server® 2012 R2 Essentials
 - Microsoft® Windows Server® 2012 R2 Standard
- The product names of Windows Server 2016 are as follows:
 - Microsoft® Windows Server® 2016 Standard
 - Microsoft® Windows Server® 2016 Datacenter
 - Microsoft® Windows Server® 2016 Essentials
 - Microsoft® Windows Server® 2016 MultiPoint® Premium Server

Other product names used herein are for identification purposes only and might be trademarks of their respective companies. We disclaim any and all rights to those marks.

Microsoft product screen shots reprinted with permission from Microsoft Corporation.

INDEX

A

- Adding toner..... 38
- Attention Light..... 13, 17
- Auxiliary tray on the paper reversal location..... 11

B

- Beeping pattern..... 65
- Bridge unit..... 16
- Bypass tray..... 12, 45, 53, 61

C

- Cannot print..... 81
- Changing the display language..... 20
- Check Status..... 67
- Control panel..... 11, 19

D

- Data In indicator..... 19
- Display panel..... 19
- Drag..... 28

E

- ENERGY STAR Program..... 95
- Envelopes..... 58
- Environmental advice for users..... 98
- Error log..... 77
- Error report..... 77
- Extender..... 12
- External options..... 16

F

- Finisher SR3210..... 17
- Finisher SR3230..... 17
- Flick..... 27
- Front cover..... 11

H

- Home screen..... 21, 28
- How to Read the Manuals..... 7

I

- Icon..... 21, 28, 29
- Indicator lamp..... 67
- Information on environmental regulations..... 95
- Internal Multi-Folding unit..... 17

- Internal options..... 17
- Internal tray 1..... 12

L

- Label paper..... 51
- Large capacity tray..... 16
- LCT..... 16, 46, 48, 54, 55
- Loading paper..... 43, 45, 46, 48
- Logging in the machine..... 80
- Long tap..... 27
- Lower paper trays..... 12, 16
- Lower right cover..... 13

M

- Mailbox..... 17
- Main power indicator..... 19
- Main power switch..... 11, 30, 31
- Manuals..... 4
- Message..... 69, 74, 76, 77, 79, 80
- Model-specific information..... 8

N

- Note for the battery and/or accumulator symbol..... 98
- Notes to users in the state of California..... 99

O

- OHP transparencies..... 51
- Options..... 9, 16
- Orientation-fixed paper..... 49
- Other printing problems..... 83
- Output jogger..... 17

P

- Paper capacity..... 51
- Paper guides..... 12
- Paper reversal location..... 11
- Paper size..... 51
- Paper thickness..... 55
- Paper tray..... 11, 43, 51
- Paper type..... 51
- Paper weight..... 51
- Pinch-in..... 26
- Pinch-out..... 27
- Printer..... 74, 76, 77

Privilege.....	80
Problem.....	69

R

Recommended paper.....	51
Region A.....	8
Region B.....	8
Removing jammed paper.....	92
Replacing consumables.....	38
Replenishing consumables.....	38
Right cover.....	12

S

Shortcut icon.....	21, 28, 29
Sleep mode.....	95
Status icon.....	66
Status indicator.....	19
Symbols.....	7

T

Thick paper.....	57
Trademarks.....	100
Translucent paper.....	51
Tray.....	11
Tray 1.....	51
Tray 2.....	51
Tray 3.....	16, 46, 51, 54
Tray 4.....	51
Turning off the power.....	31
Turning on the power.....	30
Two-sided paper.....	49

U

User information on electrical and electronic equipment.....	97
--	----

V

Vents.....	12, 13
------------	--------

W

Web Image Monitor.....	35, 36
Widget.....	29

