



User Guide

Getting Started 1

Loading Paper 2

Troubleshooting 3



For safe and correct use, be sure to read the Safety Information in Read This First before using the machine.

TABLE OF CONTENTS

Manuals for This Machine.....	3
-------------------------------	---

List of Manuals.....	5
----------------------	---

1. Getting Started

Before You Start.....	7
-----------------------	---

How to Read the Manuals.....	7
------------------------------	---

Model-Specific Information.....	8
---------------------------------	---

List of Options.....	9
----------------------	---

Guide to Names and Functions of Components.....	10
---	----

Guide to Components.....	10
--------------------------	----

Guide to the Names and Functions of the Control Panel.....	16
--	----

Guide to the Names and Functions of the Control Panel Screen.....	20
---	----

Turning On/Off the Power.....	26
-------------------------------	----

Turning On the Power.....	26
---------------------------	----

Turning Off the Power.....	26
----------------------------	----

Saving Energy.....	27
--------------------	----

Displaying the Printer Configuration Screens Using the Control Panel.....	29
---	----

Configuring Printer Settings from the [Menu] key.....	29
---	----

Configuring Printer Settings from the [User Tools] key.....	29
---	----

Monitoring and Configuring the Printer.....	31
---	----

Using Web Image Monitor.....	31
------------------------------	----

2. Loading Paper

Paper Loading Procedure.....	35
------------------------------	----

Paper Size Specifications.....	36
--------------------------------	----

Paper Type Specifications.....	38
--------------------------------	----

Paper Precautions.....	40
------------------------	----

Loading Paper into Paper Trays.....	43
-------------------------------------	----

When Loading Paper Larger than A4 or 8 ¹ / ₂ × 11.....	45
--	----

Loading Paper into the Bypass Tray.....	49
---	----

Loading Orientation-Fixed Paper or Two-Sided Paper.....	51
---	----

Loading Envelopes.....	53
------------------------	----

Printing on Envelopes with Windows (PCL 6/PostScript 3).....	54
--	----

Printing on Envelopes with Windows (PCL 5c).....	55
--	----

Printing on Envelopes with Mac OS X.....	56
--	----

Paper Settings.....	57
Specifying a Paper Size.....	57
Specifying a Paper Type.....	58
Configuring Envelope Settings Using the Control Panel.....	59

3. Troubleshooting

When a Panel Tone Beeps.....	61
When Checking the Indicator Lamps, Status Icons, and Messages on the Control Panel.....	62
Indicators.....	62
Checking Printer Status and Settings.....	62
When the Indicator Lamp for the [Check Status] Key Is Lit or Flashing.....	64
If USB Connection Fails.....	66
When Messages Are Displayed.....	67
Status Messages.....	67
Alert Messages (Displayed on the Control Panel).....	68
Alert Messages (Printed on Error Logs and Reports).....	79
When You Cannot Print.....	90
When the Data In Indicator Does Not Light Up or Flash.....	93
Other Printing Problems.....	94
When You Cannot Print Properly.....	94
Paper Misfeeds Occur Frequently.....	100
Additional Troubleshooting.....	104
The Printed Image is Different from the Image on the Computer.....	109
When Printer Is Not Functioning Properly.....	111
When PictBridge Printing Does Not Work.....	113
Removing Jammed Paper.....	114
Paper Misfeed Message (A).....	114
Misfeed Bypass Tray.....	116
Paper Misfeed Message (B).....	117
Paper Misfeed Message (Y).....	119
Paper Misfeed Message (Z).....	120
Trademarks.....	121

Manuals for This Machine

Read this manual carefully before using this machine.

Refer to the manuals that are relevant to what you want to do with the machine.

★ Important

- The method for viewing the manual depends on the manual.
- Adobe® Acrobat® Reader®/Adobe Reader must be installed in order to view the manuals as PDF files.
- A Web browser must be installed in order to view the HTML manuals.

User Guide

Summaries are provided below for the operating instructions regarding the basic usage of this machine, frequently used functions, and troubleshooting when an error message appears.

Read This First

Before using the machine, be sure to read the "Safety Information" section of this manual. It describes the regulations and environmental conformance.

Quick Installation Guide

Describes procedures from unpacking the machine to connecting it to a computer.

Operating Instructions

Provides detailed information about the operation of the machine in HTML format. The following are the main topics of the manual:

- Getting Started
- Setting Up the Printer
- Loading Paper
- Printing
- Configuring and Managing the Printer
- Troubleshooting
- Maintenance and Specifications

Extended Feature Settings

Describes how to configure the extended features using the control panel or Web Image Monitor.

Security Guide

This manual is for administrators of the machine. It explains security functions that you can use to prevent unauthorized use of the machine, data tampering, or information leakage. For enhanced security, we recommend that you first:

- Install the Device Certificate.
- Enable SSL (Secure Sockets Layer) Encryption.

-
- Change the user name and password of the administrator using Web Image Monitor.

For details, see "Before Using This Printer", Security Guide.

Be sure to read this manual when configuring the enhanced security functions or user and administrator authentication.

Driver Installation Guide

Explains how to install and configure the drivers.

List of Manuals

Manual Name	Printed Manual Provided	PDF Manual Provided	HTML Manual Provided
User Guide	No	Yes	No
Read This First	Yes	No	No
Quick Installation Guide	Yes	No	No
Operating Instructions	No	No	Yes
Extended Feature Settings	No	No	Yes
Security Guide	No	Yes	No
Driver Installation Guide	No	Yes	No



1. Getting Started

This section describes the symbols used in the manuals supplied with the printer, available options, and names and functions of components.

Before You Start

How to Read the Manuals

Symbols used in the manuals

This manual uses the following symbols:

Important

Indicates points to pay attention to when using the machine, and explanations of likely causes of paper misfeeds, damage to originals, or loss of data. Be sure to read these explanations.

Note

Indicates supplementary explanations of the machine's functions, and instructions on resolving user errors.

[]

Indicates the names of keys on the machine's display or control panels.



Indicates the key sequence order you should perform using the control panel.

Example:

Select [Host Interface]  Press [OK]

(Select [Host Interface], and then press the [OK] key.)

 **Region A** (mainly Europe and Asia)

 **Region B** (mainly North America)

Differences in the functions of Region A and Region B models are indicated by the two symbols. Read the information indicated by the symbol that corresponds to the region of the model you are using. For details about which symbol corresponds to the model you are using, see page 8 "Model-Specific Information".

Disclaimer

Contents of this manual are subject to change without prior notice.

In no event will the company be liable for direct, indirect, special, incidental, or consequential damages as a result of handling or operating the machine.

Notes

The manufacturer shall not be responsible for any damage or expense that might result from the use of parts other than genuine parts from the manufacturer with your office products.

For good output quality, the manufacturer recommends that you use genuine toner from the manufacturer.

Some illustrations in this manual might be slightly different from the machine.

About IP addresses

In this manual, "IP address" covers both IPv4 and IPv6 environments. Read the instructions that are relevant to the environment you are using.

Model-Specific Information

This section explains how to identify the region to which your printer belongs.

There is a label on the rear of the printer, located in the position shown below. The label contains details that identify the region to which your printer belongs. Read the label.

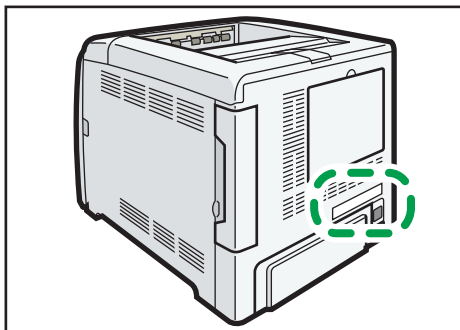

DPP283

The following information is region-specific. Read the information under the symbol that corresponds to the region of your printer.

 **Region A** (mainly Europe and Asia)

If the label contains the following, your printer is a Region A model:

- CODE XXXX -27
- 220–240 V

 **Region B** (mainly North America)

If the label contains the following, your printer is a Region B model:

- CODE XXXX -17
- 120–127 V

Note

- Dimensions in this manual are given in two measurement units: metric and imperial. If your printer is a Region A model, refer to the metric units. If your printer is a Region B model, refer to the imperial units.

List of Options

This section provides a list of options for this printer and the names commonly used in this manual.

Option name	Description
Paper Feed Unit TK1220	500-sheet paper feed unit
Hard Disk Drive Option Type P10*	Hard disk
IEEE 802.11 Interface Unit Type M24	Wireless LAN interface board
IEEE 1284 Interface Board Type M19*	IEEE 1284 interface board
USB Device Server Option Type M19*	USB device server board
Camera Direct Print Card Type P10*	Camera direct print card
VM CARD Type P10*	VM card
XPS Direct Print Option Type P10*	XPS card

* These options are available for SP 342DN.

Guide to Names and Functions of Components

Guide to Components

⚠ CAUTION

- Do not obstruct the machine's vents. Doing so risks fire caused by overheated internal components.

Exterior: Front view

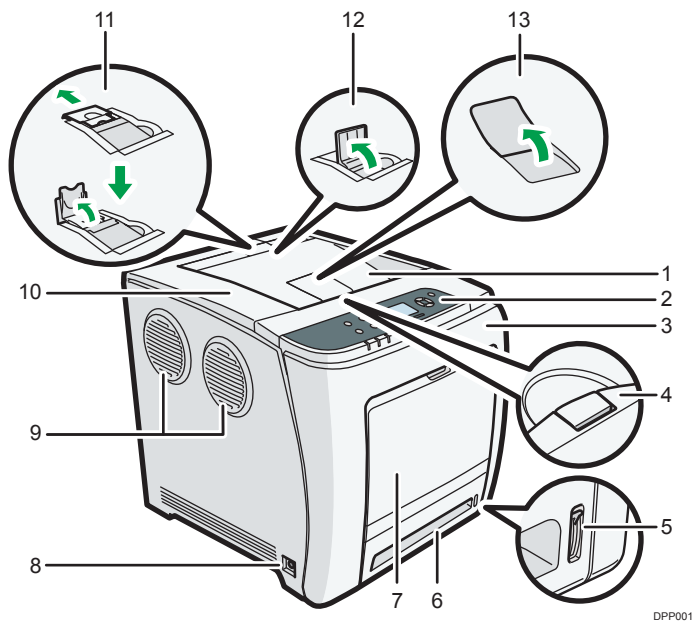

DPP001

1. Standard tray

Output is stacked here with the print side down.

2. Control panel

For details, see page 16 "Guide to the Names and Functions of the Control Panel".

SP C342DN

You can set the display up with your hands. Adjust the angle of it to see clearly.

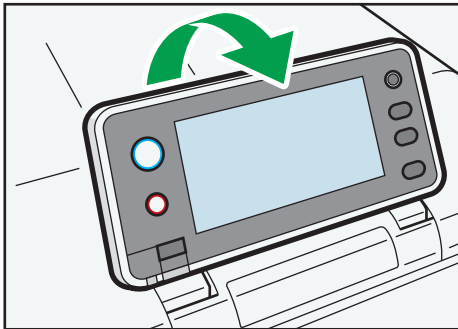

DPP088

3. Front cover

Open this cover when replacing the waste toner bottle, etc., or removing jammed paper.

Pull the right side lever to open the front cover.

4. Top cover open lever

Pull this lever upward to open the top cover.

5. Remaining paper indicator

Indicates the approximate amount of paper remaining in the tray.

6. Standard paper feed tray (Tray 1)

Up to 500 sheets of plain paper can be loaded.

For details about the sizes and types of paper that can be used, see page 36 "Paper Size Specifications" and page 38 "Paper Type Specifications".

7. Bypass tray

Up to 100 sheets of plain paper can be loaded.

For details about the sizes and types of paper that can be used, see page 36 "Paper Size Specifications" and page 38 "Paper Type Specifications".

8. Main power switch

Use this switch to turn the power on and off.

Perform the shutdown procedure before turning the power off. For details about how to shut down the printer, see page 26 "Turning Off the Power".

9. Outlet Ventilation Hole

This vents the air to prevent the temperature inside the printer from rising. Be sure not to block it by placing something against it. Doing so will cause the temperature inside the printer to rise, resulting in a malfunction. You can turn the ventilation hole to vent the air in a different direction.

10. Top cover

Open this cover to replace the print cartridge

11. Stop Fence (Legal-size prints)

Raise the rear fence to prevent Legal-size prints from falling behind the printer.

After using the stop fence, be sure to return it to its original position. The fence may be damaged if it is hit with something or excessive force is applied.

12. Stop Fence (A4/Letter-size prints)

Raise the front fence to prevent A4 or letter-size prints from falling behind the printer.

After using the stop fence, be sure to return it to its original position. The fence may be damaged if it is hit with something or excessive force is applied.

13. Standard Tray Extension

Use this to support sheets that come out curled after they are printed.

Flip open the extension by pushing down on the end that is toward the rear of the printer.

Exterior: Rear view

SP C340DN

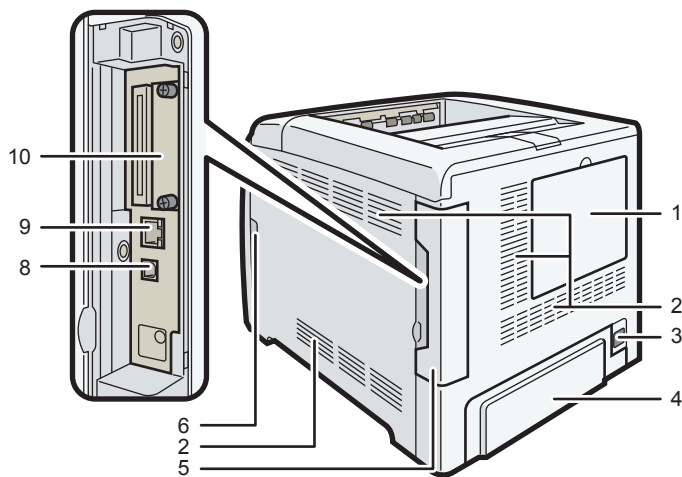

DPP094

SP C342DN

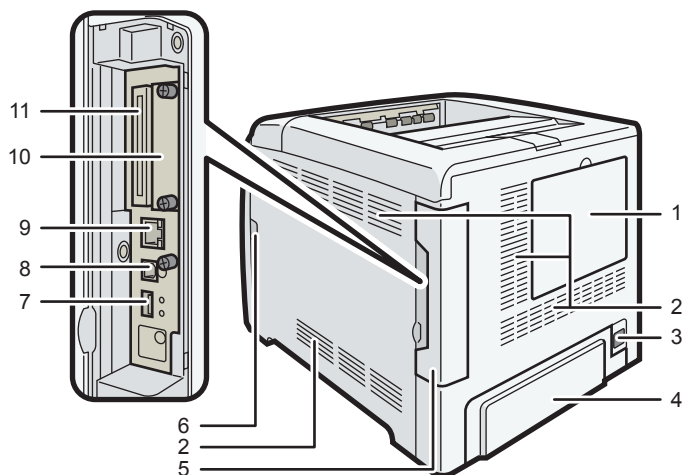

DPP002

1. HDD cover

Remove this cover to install the optional hard disk.

2. Inlet Ventilation Hole

This draws in the air to prevent the temperature inside the printer from rising. Be sure not to block it by placing something against it. Doing so will cause the temperature inside the printer to rise, resulting in a malfunction.

3. Power connector

Connect the power cord to the printer. Insert the other end into an electrical outlet.

4. Rear cover

Raise this cover and attach the paper tray cover when loading paper larger than A4 or letter size paper.

5. Cable cover

Remove this cover to install the optional interface units and the SD card, and to connect various cables.

6. Front cover open lever

Pull this lever to open the front cover.

7. USB port A

Connect external devices such as a digital camera, a card authentication device, etc.

8. USB port B

Use a USB cable to connect the printer to a computer.

9. Ethernet port

Use a network interface cable to connect the printer to a network.

10. Optional interface board slot

Optional interface boards can be inserted.

Insert an optional wireless LAN interface board, IEEE 1284 interface board, or USB device server.

11. Expansion card slots

Remove the cover to install SD cards.

Interior: Front view

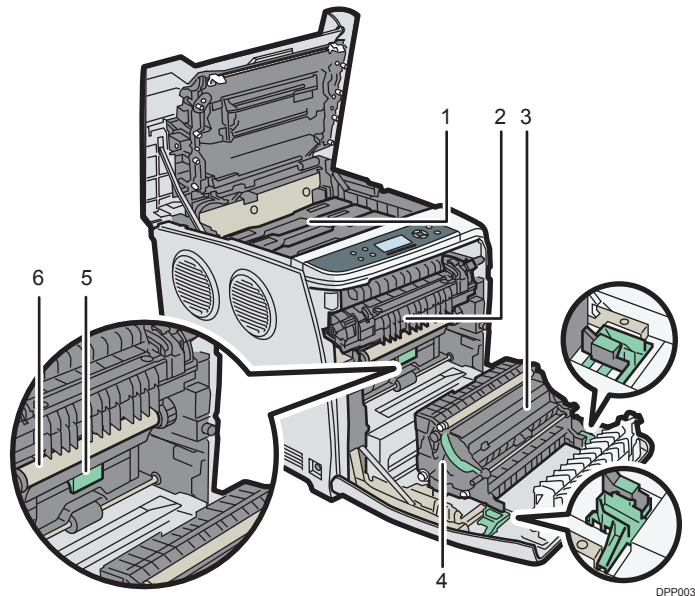

1. Print cartridge

Loads from the printer rear, in the order of cyan (C), magenta (M), yellow (Y), and black (K).

Messages appear on the screen when the print cartridge needs to be replaced, or a new cartridge needs to be prepared.

For details about the messages that appear on the screen when consumables need to be replaced, see "Replenishing and Replacing Consumables", Operating Instructions.

2. Fusing unit

Messages appear on the screen when the fusing unit needs to be replaced, or a new fusing unit needs to be prepared.

For details about the messages that appear on the screen when consumables need to be replaced, see "Replenishing and Replacing Consumables", Operating Instructions.

3. Transfer roller

If the message appears on the control panel, replace the transfer roller, which is included with the intermediate transfer unit.

For details about the messages that appear on the screen when consumables need to be replaced, see "Replenishing and Replacing Consumables", Operating Instructions.

Replace the transfer roller and the intermediate transfer unit together.

4. Paper Transfer Unit

Remove this unit when replacing the waste toner bottle, intermediate transfer unit.

5. Waste toner bottle

Collects toner that is wasted during printing.

Messages appear on the screen when the waste toner bottle needs to be replaced, or a new waste toner bottle needs to be prepared.

For details about the messages that appear on the screen when consumables need to be replaced, see "Replenishing and Replacing Consumables", Operating Instructions.

6. Intermediate transfer unit

Messages appear on the screen when the intermediate transfer unit needs to be replaced, or a new intermediate transfer unit needs to be prepared.

For details about the messages that appear on the screen when consumables need to be replaced, see "Replenishing and Replacing Consumables", Operating Instructions.

Guide to functions of the printer's internal options

SP C340DN

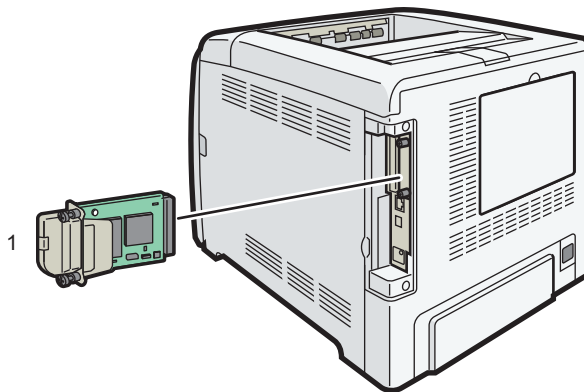

DPP100

SP C342DN

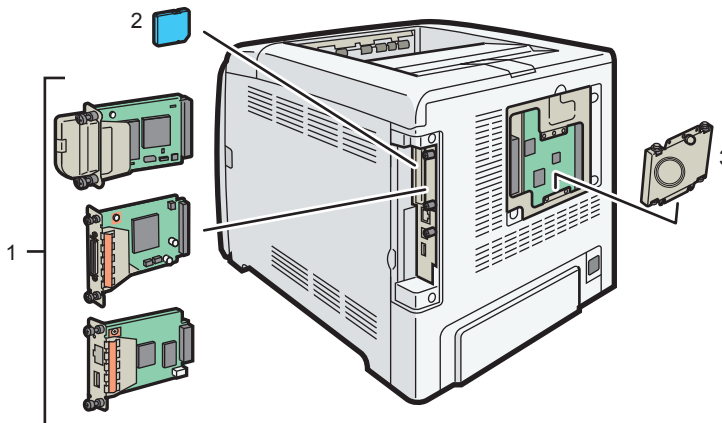

DPP004

1. Optional interface units

- Wireless LAN board
Allows you to communicate over wireless LAN.
- IEEE 1284 interface board (SP C342DN only)
Allows you to connect to an IEEE 1284 cable.
- USB device server (SP C342DN only)
Allows you to add an Ethernet port to the printer and use two IP addresses at the same time.

To attach this option, see "Installing the Interface Units", Operating Instructions.

2. SD memory card options (SP C342DN only)

- Camera direct print card
Allows you to directly print images taken with a PictBridge-compatible digital camera.
- VM card
With this card, you can install embedded software applications.
- XPS card
Allows you to print XPS files.

To attach this option, see "Installing SD Card Options", Operating Instructions.

3. Hard disk (SP C342DN only)

Allows you to store documents to be printed.

To attach this option, see "Installing the hard disk", Operating Instructions.

Note

- If you want to use two or more SD cards that can be inserted in the same slot, contact your sales or service representative.

Guide to the Names and Functions of the Control Panel

This illustration shows the control panel of the printer.

SP C340DN

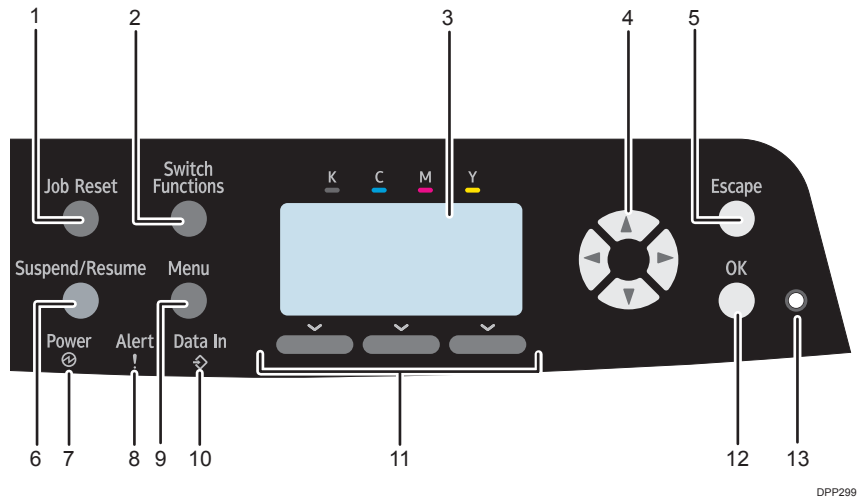

1. [Job Reset] key

Press to cancel the current print job.

2. [Switch Functions] key

Press this key to switch between the operation screen of the printer function and the function screens of the extended features currently in use.

3. Display

Displays current printer status and error messages.

Entering energy saver mode turns off the back light. For details about energy saver mode, see page 27 "Saving Energy".

4. Scroll keys

Press these keys to move the cursor in each direction.

When the [▲] [▼] [◀] [▶] keys appear in this manual, press the applicable key for the direction that you want to move the cursor.

5. [Escape] key

Press this key to cancel an operation or return to the previous display.

6. [Suspend/Resume] key

Press this to suspend the print job currently being processed. The indicator remains lit as long as the job is suspended.

To resume the job, press this key again. The suspended job will resume automatically when the time specified in [Auto Reset Timer] elapses (default: **60 seconds**).

For details about the [Auto Reset Timer] setting, see "Timer Settings (SP C340DN)", Operating Instructions.

7. Power indicator

Lights up when the printer is ready to receive data from a computer. Flashes when the printer is warming up or receiving data. It is unlit when the power is off or when the printer is in energy saver mode.

8. Alert indicator

Lights up or flashes when a printer error occurs.

Steady red: printing is not possible, or is possible but print quality cannot be ensured.

Flashing yellow: the printer will soon require maintenance or a replacement consumable such as print cartridge.

Follow the instructions that appear on the display.

9. [Menu] key

Press this key to configure and check the current printer settings.

Press to change the default settings to meet your requirements. See page 29 "Displaying the Printer Configuration Screens Using the Control Panel".

10. Data in indicator

Flashes when the printer is receiving data from a computer. The data in indicator is lit if there is data to be printed.

11. Selection keys

Correspond to the function items at the bottom line on the display.

Example: When this manual instructs you to press [Option], press the selection key on the left below the initial screen.

12. [OK] key

Use this key to confirm settings or setting values, or move to the next menu level.

13. Light sensor

The sensor that detects the ambient light level when the ECO Night Sensor function is enabled.

SP C342DN

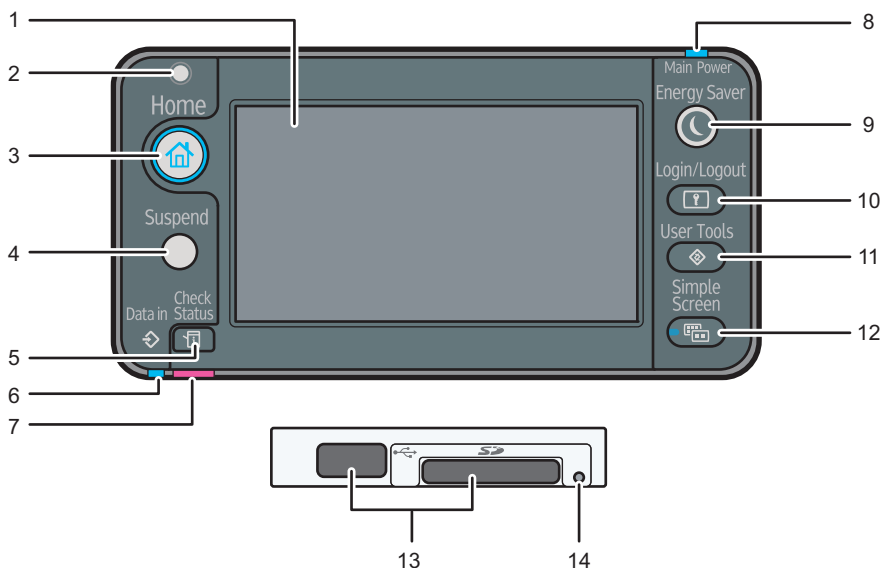

DPP101

1. Display panel

Displays function keys, operation status, and messages. See page 20 "Guide to the Names and Functions of the Control Panel Screen".

2. Light Sensor

Indicates that the sensor that detects the ambient light level when the ECO Night Sensor function is enabled.

3. [Home] key

Press to display the [Home] screen. For details, see page 22 "Using the [Home] screen".

4. [Suspend] key

Press this key to suspend a print job. The key lights up while the job is suspended.

5. [Check Status] key

Press to check the printer's system status, operational status of each function, and current jobs. You can also display the job history and the printer's maintenance information.

6. Data In indicator

Flashes when the printer is receiving print jobs from a computer. The indicator lights up when there is data to be printed.

7. Check Status indicator

Lights up or flashes when a printer error occurs.

Steady red: Printing is not possible.

Flashing yellow: The printer will soon require maintenance or a replacement consumable such as a print cartridge. Printing is possible, but print quality cannot be ensured.

Follow the instructions that appear on the display.

8. Power indicator

Remains lit while the power is on. It is not lit when the power is off or when the printer is in energy saver mode.

9. [Energy Saver] key

Press to switch to and from Sleep mode. See page 27 "Saving Energy". When the printer is in Sleep mode, the [Energy Saver] key flashes slowly.

10. [Login/Logout] key

Press to log in or log out.

11. [User Tools] key

Press to change the default settings as needed. See page 29 "Configuring Printer Settings from the [User Tools] key".

12. [Simple Screen] key

Press to switch to the simple screen. See "Switching screen patterns", Operating Instructions.

13. Media slots

Insert an SD card or a USB flash memory device.

14. Media access lamp

Lights up when a memory storage device is inserted in the media slot or is being accessed.

Guide to the Names and Functions of the Control Panel Screen

SP C340DN

1

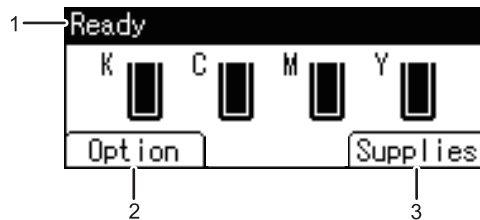

DPP083

1. Operational Status or Messages

Displays the printer status and messages.

2. [Option]

Press to display the following items:

- Form Feed
- Error Log

3. [Supplies]

Press to display the information about printer supplies.

↓ Note

- By default, the remaining amount of toner is displayed. To avoid displaying the remaining amount of toner, set [Display Supply Info] to [Off] in [General Settings] under [Maintenance].
- The control panel of the SP C341 is not a touchpanel. Do not touch the screen directly.

SP C342DN

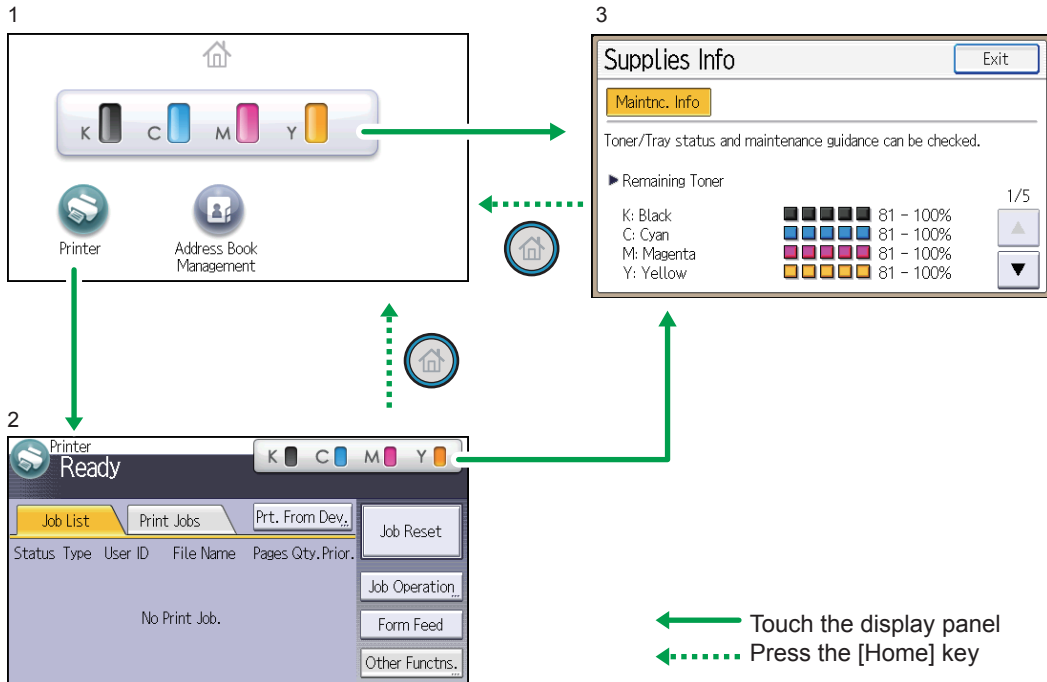

C2V301

1. [Home] screen

Displays function and shortcut icons. For details, see page 22 "Using the [Home] screen".

The [Home] screen is set as the default screen when the printer is turned on. You can change this default setting under Function Priority. See "System Settings (SP C342DN)", Operating Instructions.

2. [Printer] screen

Displays operation status, messages, and function menus. For details, see page 23 "Using the [Printer] screen".

3. [Supplies Info] screen

Checks the printer status, such as toner, paper, and waste toner levels.

↓ Note

- After finishing a job, the printer waits a specified length of time, then restores its settings to the default values specified under Function Priority. This function is called "System Reset". For the procedure for specifying default settings under Function Priority, see "System Settings (SP C342DN)", Operating Instructions.
- To change the length of time that the printer waits before restoring its settings to their default values, use the Printer Auto Reset Timer setting. See "System Settings (SP C342DN)", Operating Instructions.

Using the [Home] screen

This function is available for SP 342DN only.

To display the [Home] screen, press the [Home] key.

Each function has its own icon, and these icons are displayed on the [Home] screen.

You can add shortcuts to frequently used embedded software applications to the [Home] screen. The icons of added shortcuts appear on the [Home] screen. The embedded software applications can be called easily by pressing the shortcut icons.

★ Important

- Do not apply strong impact or force to the screen. Doing so will damage the screen. Maximum force allowable is approx. 30 N (approx. 3 kgf). (N = Newton, kgf = Kilogram force. 1 kgf = 9.8 N.)

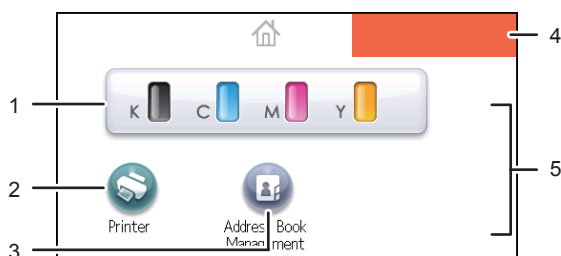

CZV302

1. Supply Information icon

Press to display the [Supplies Info] screen to check toner, paper, and waste toner levels.

2. [Printer]

Press to display the [Printer] screen.

3. Shortcut icon area

You can add shortcuts to embedded software applications to the [Home] screen. For details about registering shortcuts, see "Adding icons to the [Home] screen", Operating Instructions.

4. Home screen image

You can display an image such as a corporate logo on the [Home] screen. To change the image, see "Displaying the image on the [Home] screen", Operating Instructions.

5. ▲/▼

These appear if you add an application and it causes the icons to appear over multiple pages. Use these to move between the pages.

↓ Note

- When a software application to be embedded is installed, the function icon for the application is displayed on the [Home] screen.
- You can change the order of the icons. For details, see "Changing the order of icons on the [Home] screen", Operating Instructions.

Using the [Printer] screen

This function is available for SP C342DN only.

The display panel shows the operation status, messages, and function menus.

The function items displayed serve as selector keys. You can select or specify an item by lightly pressing these keys.

When you select or specify an item on the display panel, it is highlighted such as . Keys appearing as  cannot be used.

★ Important

- Do not apply strong impact or force to the screen. Doing so will damage the screen. Maximum force allowable is approx. 30N (approx. 3 kgf). (N = Newton, kgf = Kilogram force. 1 kgf = 9.8N.)

The [Home] screen is set as the default screen when the printer is turned on.

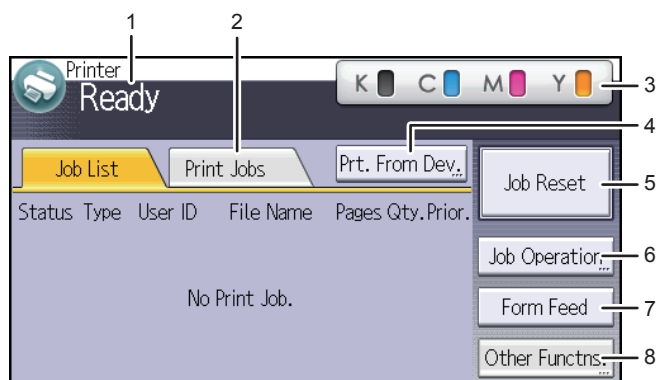

CZV303

1. Operational status or messages

Displays the current printer status, such as "Ready", "Offline", and "Printing...". Information (user ID and document name) about the print job appears in this section.

2. [Print Jobs]

Press to display print jobs sent from a computer.

3. Supply Information

You can check the remaining toner. Press to display the [Supplies Info] screen.

4. [Prt. From Dev.]

Press to display the screen for directly printing files stored on memory storage devices.

5. [Job Reset]

Press to cancel the current print job.

If you press it when the Hex Dump is selected, Hex Dump is canceled.

6. [Job Operation]

Press to suspend a job being processed.

7. [Form Feed]

Press to print all the data left in the printer's input buffer.

8. [Other Functns.]

Press to display the error logs and status of spooled jobs.

Using the [Information] screen

This function is available for SP C342DN only.

To raise environmental awareness, you can configure the printer to show users the amount of paper saved by using the various paper saving functions of the printer.

The color utilization ratio is also displayed on the [Information] screen.

When user authentication is enabled, the screen is displayed when you log in to the printer. When user authentication is not enabled, the screen is displayed after the printer returns from Sleep mode or after a system reset. The [Information] screen appears when the power is turned on, regardless of the authentication settings.

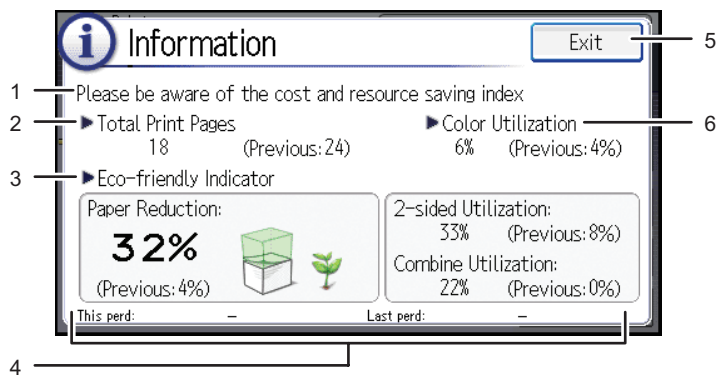

CZV304

1. Message

Displays messages from the administrator.

2. Total Print Pages

Displays the total number of pages printed in the current count period and the previous count period.

3. Eco-friendly Indicator

- **Paper Reduction:**
Shows the amount of paper saved by using the duplex and combine printing functions. The value indicates the percentage of paper saved from the total of all the paper used. As the percentage increases, the stack of paper decreases and the flower grows. When the ratio is 76% or more, the flower starts to bloom.
- **2 sided Utilization:**

Displays the ratio of 2-sided prints to the total number of prints.

- **Combine Utilization:**

Displays the ratio of combined prints to the total number of prints.

4. **Count periods**

Displays the current and previous count periods.

5. **[Exit]**

Press this to close the [Information] screen and return to operation.

6. **Color Utilization**

Displays the ratio of color prints to the total number of prints.

Note

- Depending on the printer settings, the [Information] screen may not be displayed. For details, see "Managing Eco-friendly Counter", Security Guide.
- You can also use Web Image Monitor to check the usage status. For further details, see Web Image Monitor Help.
- Under [Eco-friendly Counter Period/Administrator Message] in [System Settings], you can check "Count Period", "Administrator Message", "Display Information Screen", and "Display Time". Only the administrator can change the settings. For details, see Security Guide.

Turning On/Off the Power

This section explains how to turn on/off the printer.

Turning On the Power

1. Make sure the power cord is firmly plugged into the wall outlet.
2. Push the main power switch.

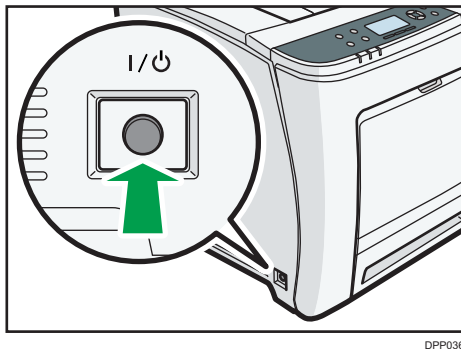

The power indicator turns on.

↓ Note

- After you switch the main power on, a screen may appear to indicate that the printer is initializing. Do not switch the power off during this process. Initialization takes about three minutes.

Turning Off the Power

⚠ CAUTION

- When disconnecting the power cord from the wall outlet, always pull the plug, not the cord. Pulling the cord can damage the power cord. Use of damaged power cords could result in fire or electric shock.

★ Important

- Do not press and hold the main power switch when turning off the printer. Doing so shuts down the printer forcefully and may damage the hard disk causing a malfunction of the printer.
- Before unplugging the power cord plug, turn off the power switch and make sure the power switch indicator turns off. Not doing so may result in damage to the hard disk or memory, leading to a malfunction.
- Do not turn off the power while the printer is in operation.

1. Push the main power switch.

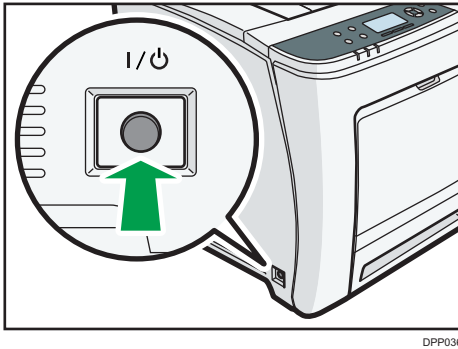

DPP036

The main power is turned off automatically when the shutdown process is complete.

If the shutdown process is not complete within the period of time displayed on the screen, contact your service representative.

Saving Energy

This printer has the following energy saving functions:

Sleep mode

If the printer remains inactive for a specified period after entering Fusing Unit Off mode, it enters Sleep mode to further reduce the power consumption. The printer also enters Sleep mode when:

- The printer waits before entering Sleep mode is set in [Sleep Mode Timer]
- It is the day and time specified in [Weekly Timer]

When the printer is in Sleep mode, only the [Energy Saver] key and the [Check Status] key are usable. (for SP C342DN)

The printer can print jobs from computers.

You can change the amount of time that the printer waits before switching to Sleep mode.

For details about setting [Sleep Mode Timer] and [Weekly Timer], see:

- "System (SP C340DN)", Operating Instructions.
- "Timer Settings (SP C342DN)", Operating Instructions.

To exit Sleep mode, do one of the following:

- Press one of the keys on the control panel (for SP C340DN)
- Press the [Energy Saver] key or [Check Status] key (for SP C342DN)
- Start print jobs

ECO Night Sensor

ECO Night Sensor can detect darkness and automatically turn off this product's power.

If ECO Night Sensor is enabled and detects darkness in a room after the lights are turned off, the sensor automatically turns the power off and reduces the power consumption of this product to 1W or less.

The default settings of ECO Night Sensor are enabled.

To change the settings, see:

- "System (SP C340DN)", Operating Instructions.
- "Administrator Tools (SP C342DN)", Operating Instructions.

★ Important

- **The ECO Night Sensor function's factory default is [Auto Power Off Only]. If the printer is located in an environment where the ambient light level is low (such as in a hallway or a location with motion sensor lighting), it is advisable that you either keep this function disabled or adjust its sensitivity.**
- **You can configure the printer to automatically turn its power on when it detects an increase in the ambient light level. The printer may also react to daylight and turn its power on. If the printer is located in an environment where it is exposed to direct sunlight, it is advisable that you do not change the factory default configuration and only enable [Auto Power Off Only].**

↓ Note

- When the printer is in Sleep mode, the [Energy Saver] key flashes slowly. (for SP C342DN)
- The energy saving functions will not activate when:
 - Communicating with external devices
 - The hard disk is active
 - A warning message is displayed
 - The service call message is displayed
 - Paper is jammed
 - The printer's covers are opened
 - Toner is being replenished
 - The printer settings screen is displayed
 - Fixed warm-up is in progress
 - Data is being processed
 - Operations are suspended during printing
 - The Data In indicator is on or flashing
 - The sample print, locked print, hold print, or stored print screen is displayed
 - Accessing the printer using Web Image Monitor
- The printer consumes less energy when in Sleep mode, but it takes longer to start printing.
- If two or more energy saving functions are set, the function for which the predetermined conditions to enter energy saving mode are met takes effect first.

Displaying the Printer Configuration Screens Using the Control Panel

Configuring Printer Settings from the [Menu] key

This function is available for SP C340DN only. If you are using SP C342DN, see page 29 "Configuring Printer Settings from the [User Tools] key".

The configuration screens allow you to change or set defaults.

★ Important

- If Administrator Authentication Management is specified, contact your administrator.

1. Press the [Menu] key.

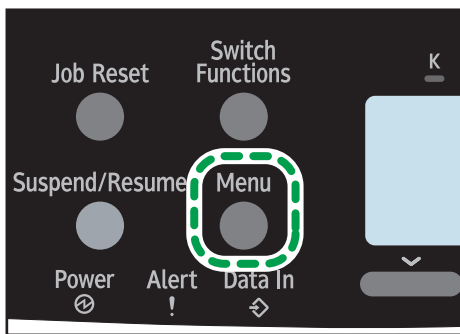

2. Select the settings you want to change.

Press the [▼] or [▲] key to select the next or previous items.

3. Press the [OK] key.

↓ Note

- Any changes you make with configuration screens remain in effect even if the main power switch is turned off.
- To cancel changes made to settings and return to the initial display, press the [Escape] key.

Configuring Printer Settings from the [User Tools] key

This function is available for SP C342DN only. If you are using SP C340DN, see page 29 "Displaying the Printer Configuration Screens Using the Control Panel".

This section explains the setting items available on the [User Tools] screen of the printer.

The configuration screens allow you to change or set the default settings.

★ Important

- If Administrator Authentication Management is specified, contact your administrator.

1. Press the [User Tools] key.

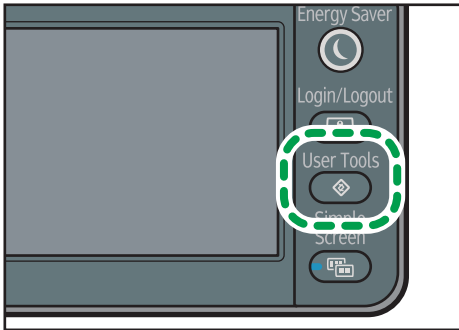

CZV010

2. Select the settings you want to change.

Press [▼] or [▲] to display the next or previous page.

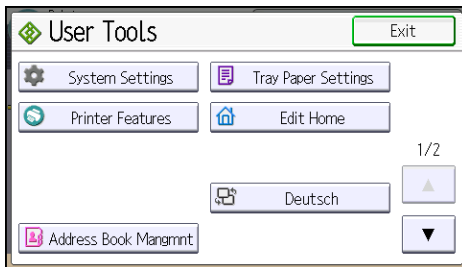

3. Change the settings by following the instructions on the display, and then press [OK].

4. Press the [User Tools] key.

↓ Note

- Any changes you make with the configuration screens remain in effect even if the main power switch is turned off.
- To cancel changes made to the settings and return to the initial display, press the [User Tools] key.

Monitoring and Configuring the Printer

This section explains how to monitor and configure the printer.

Using Web Image Monitor

★ Important

- You cannot configure the printer settings using Web Image Monitor from a computer connected to the USB device server's network. Be sure to access Web Image Monitor from the printer's network.

Using Web Image Monitor, you can check the printer status and change settings.

Available operations

The following operations can be remotely performed using Web Image Monitor from a client computer.

- Displaying printer status or settings
- Checking the print job status or history
- Interrupting currently printing jobs
- Resetting the printer
- Managing the Address Book
- Configuring printer settings
- Configuring network protocol settings
- Configuring security settings

Configuring the printer

To perform the operations from Web Image Monitor, TCP/IP is required. After the printer is configured to use TCP/IP, operations from Web Image Monitor become available.

Recommended Web browser

- Windows:
 - Internet Explorer 6.0 or higher
 - Firefox 10 and 15 or higher
 - Google Chrome 19 or higher
- Mac OS:
 - Safari 3.0 or higher
 - Firefox 10 and 15 or higher
 - Google Chrome 19 or higher

Web Image Monitor supports screen reader software. We recommend JAWS 7.0 or a later version.

Note

- Display and operation problems may occur if you do not enable JavaScript and cookies, or if you are using a non-recommended Web browser.
- If you are using a proxy server, change the Web browser settings. Contact your administrator for information about the settings.
- We recommend using Web Image Monitor in the same network.
- If the printer is firewall-protected, it cannot be accessed from computers outside the firewall.
- If the printer under DHCP is used, the IP address may be changed automatically by the DHCP server settings. Enable DDNS setting on the printer, and then connect using the printer's host name. Alternatively, set a static IP address to the DHCP server.
- If the HTTP port is disabled, a connection to the printer using the printer's URL cannot be established. SSL settings must be enabled on this printer. For details, contact your network administrator.
- If Firefox is used, fonts and colors may be different, or tables may not appear properly configured.
- When using a host name under Windows Server 2003/2003 R2/2008/2008 R2/2012/2012 R2 with IPv6 protocol, perform host name resolution using an external DNS server. The host file cannot be used.
- To use JAWS 7.0 under Web Image Monitor, you must be running Windows and Internet Explorer 6.0 or a later version.
- If you are using Internet Explorer 8.0 or higher, downloading will be slower than with other browsers. To download faster with Internet Explorer 8.0 or higher, open the browser's [Internet Options] menu and register the printer's URL as a trusted site, and then disable SmartScreen filter for trusted sites. For details about these settings, see the Internet Explorer Help files.
- You can access Web Image Monitor more quickly by registering the printer's URL as a bookmark. Note that the URL you register must be the URL of the top page, which is the page that appears before login. If you register the URL of a page that appears after login, Web Image Monitor will not open properly from the bookmark.
- If user authentication is activated, you must enter your login user name and password to use Web Image Monitor. For Details, see page 32 "Displaying the top page".
- When you configure settings using Web Image Monitor, do not log in from the control panel. The settings you have configured using Web Image Monitor may become invalid.

Displaying the top page

There are two modes available with Web Image Monitor: guest mode and administrator mode.

Displayed items may differ depending on the printer type.

Guest mode

This mode requires no login to enter.

In the guest mode, the printer status, settings, and print job status can be viewed, but the printer settings cannot be changed.

Administrator mode

This mode requires an administrator login to enter.

In the administrator mode, you can configure various printer settings.

★ Important

- When entering an IPv4 address, do not begin segments with zeros. For example: If the address is "192.168.001.010", you must enter it as "192.168.1.10".

1. Start your Web browser.

2. Enter "http://(printer's IP address or host name)/" in your Web browser's address bar.

The top page of Web Image Monitor appears.

If the printer's host name has been registered on the DNS or WINS server, you can enter it.

When setting SSL, a protocol for encrypted communication, under the environment in which server authentication is issued, enter "https://(printer's IP address or host name)/".

3. To log in to Web Image Monitor in the administrator mode, click [Login] on the top page.

The window for entering the login user name and password appears.

4. Enter your login user name and password, and then click [Login].

For details about the login user name and password, contact your administrator.

Depending on the configuration of your Web browser, the login user name and password might be saved. If you do not want to save them, configure your Web browser's settings so that this information is not saved.

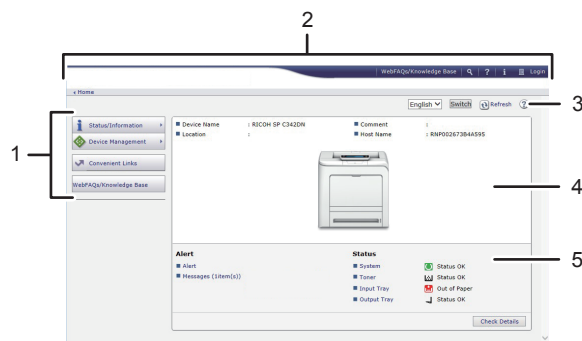

DPP284



1. Menu area

Displays the content of a selected menu item.

2. Header area

Displays the dialog box for switching to the user mode and administrator mode and the menu for each mode. Also displays the link to Help and dialog box for keyword search.

3. Refresh/Help

 (Refresh): Click  at the upper right in the work area to update the printer information. Click the Web browser's [Refresh] button to refresh the entire browser screen.

 (Help): Use Help to view or download Help file contents.

4. Basic Information area

Displays the basic information of the printer.

5. Work area

Displays the contents of the item selected in the menu area.

2. Loading Paper

This chapter describes available trays for each paper size and type, and explains how to load paper in paper trays.

Paper Loading Procedure

2

To achieve the print results you expect, it is important to select an appropriate input tray according to the size, type, and weight of the paper you want to use for printing. You also need to specify the paper size and type properly using the control panel or Web Image Monitor, and/or the paper size dial on the tray.

Follow the procedure below to load paper.

- 1. Check the paper tray available for the size, type, and weight of the paper you want to use for printing.**

For details about available paper trays for each paper size and type, see page 36 "Paper Size Specifications" and page 38 "Paper Type Specifications".

- 2. Change the paper size and type settings for the tray you selected.**

Use the control panel of the printer or Web Image Monitor to change the paper size and type.



For details about changing paper settings using the control panel, see page 57 "Paper Settings".

- 3. Load paper into the tray.**

For details about loading paper, see page 43 "Loading Paper into Paper Trays" or page 49 "Loading Paper into the Bypass Tray".

For details about loading envelopes, see page 53 "Loading Envelopes".







Paper Size Specifications

The following tables show the paper sizes that can be loaded in each paper tray. The "Paper size" column shows the names of paper sizes and their dimensions in millimeters and inches. The  and  icons indicate the paper orientation in relation to the printer body.







The letters in the tables indicate the following:





- A: Select the paper size using the control panel.
- ✓: You can print on both sides of paper.
- -: Not supported

Metric sizes

Paper size name	Actual size	Bypass tray	Tray 1	Trays 2	Two-sided
A4 	210 × 297 mm	A	A	A	✓
A5 	148 × 210 mm	A	A	-	-
A6 	105 × 148 mm	A	-	-	-
B5 	182 × 257 mm	A	A	-	✓
B6 	128 × 182 mm	A	-	-	-
C5 Env 	162 × 229 mm	A	-	-	-
C6 Env 	114 × 162 mm	A	-	-	-
DL Env 	110 × 220 mm	A	-	-	-
16K 	195 × 267 mm	A	A	-	✓

Imperial sizes

Paper size name	Actual size	Bypass tray	Tray 1	Trays 2	Two-sided
8 ¹ / ₂ × 14 	8.5" × 14"	A	A	-	✓
8 ¹ / ₂ × 13 ² / ₅ 	8.5" × 13.4"	A	A	-	✓
8 ¹ / ₂ × 13 	8.5" × 13"	A	A	-	✓
8 ¹ / ₂ × 11 	8.5" × 11"	A	A	A	✓
8 ¹ / ₄ × 13 	8.25" × 13"	A	A	-	✓
8 × 13 	8" × 13"	A	A	-	✓

Paper size name	Actual size	Bypass tray	Tray 1	Trays 2	Two-sided
$7\frac{1}{4} \times 10\frac{1}{2}$ 	7.25" x 10.5"	A	A	-	✓
$5\frac{1}{2} \times 8\frac{1}{2}$ 	5.5" x 8.5"	A	-	-	-
$4\frac{1}{8} \times 9\frac{1}{2}$ 	4.125" x 9.5"	A	-	-	-
$3\frac{7}{8} \times 7\frac{1}{2}$ 	3.875" x 7.5"	A	-	-	-

Custom Size Specifications

You can also load custom size paper by specifying horizontal and vertical sizes.

The following tables show the custom paper sizes that can be loaded in each tray.

Metric sizes

Tray	Horizontal size (One-sided)	Vertical size (One-sided)	Horizontal size (Two-sided)	Vertical size (Two-sided)
Bypass tray	64.0 to 216.0 mm	125.0 to 1260.0 mm	90 to 216.0 mm	240 to 356.0 mm
Tray 1	148.0 to 216.0 mm	210.0 to 356.0 mm	90.0 to 216.0 mm	240 to 356.0 mm

Imperial sizes

Tray	Horizontal size (One-sided)	Vertical size (One-sided)	Horizontal size (Two-sided)	Vertical size (Two-sided)
Bypass tray	2.52 to 8.50"	4.93 to 49.60"	3.55 to 8.50"	9.45 to 14.01"
Tray 1	5.83 to 8.50"	8.27 to 14.01"	5.83 to 8.50"	9.45 to 14.01"

Paper Type Specifications

The following table show the paper types that can be loaded in each tray. See “Paper weight” table for the actual paper weight indicated by numbers in the “Paper weight No.” column. Use both tables to specify the correct paper type for the paper you are using.

The letters in the tables indicate the following:

- A: Supported
- ✓: You can print on both sides of paper.
- -: Not supported

Paper type	Paper weight No.	Bypass tray	Tray 1	Trays 2	Two-sided
Thin Paper	1	A	A	A	✓
Plain Paper	2	A	A	A	✓
Middle Thick Paper	3	A	A	A	✓
Thick Paper 1	4	A	A	A	-
Thick Paper 2	5	A	A	-	-
Thick Paper 3	6	A	-	-	-
Recycled Paper	2	A	A	A	✓
Color Paper	2	A	A	A	✓
Special Paper 1	2	A	A	-	✓
Special Paper 2	2	A	A	-	✓
Special Paper 3	2	A	-	-	-
Letterhead	2	A	A	A	✓
Preprinted Paper	2	A	A	A	✓
Bond Paper	2	A	-	-	-
Cardstock	2	A	A	A	✓
Label Paper	2	A	A	-	-
Envelope	2	A	-	-	-

Paper type	Paper weight No.	Bypass tray	Tray 1	Trays 2	Two-sided
Coated: Glossy	2	A	A	-	✓
Coated: Matte	2	A	-	-	✓
Coated: Gloss: Thick	4	A	-	-	-
Coated: Matte: Thick	4	A	-	-	-

Paper weight

No.	Paper weight
1	60–65 g/m ² (15–18 lb. BOND)
2	66–74 g/m ² (18–20 lb. BOND)
3	75–90 g/m ² (20–24 lb. BOND)
4	91–105 g/m ² (24–34 lb. BOND)
5	106–163 g/m ² (34 lb. BOND–90 lb. INDEX)
6	164–220 g/m ² (90 lb. INDEX–80 lb. COVER)

Paper Precautions

CAUTION

- Do not attempt to print on stapled sheets, aluminum foil, carbon paper, or any kind of conductive paper. Doing so risks fire.

Precautions

- Do not use acidic paper because it accelerates the deterioration of the drum unit and surrounding parts.
- If paper jams occur or multiple sheets are fed at once, fan the paper before loading it.

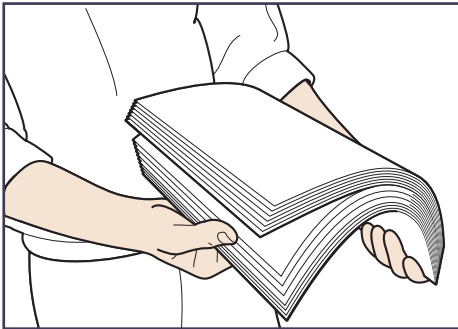

CBK254

- If you load paper when only a few sheets of paper remain in the tray, multiple sheet feeding may occur. Remove any remaining paper, stack them upon the new sheets of paper, and then fan the entire stack before loading it into the tray.
- Straighten curled or warped paper before loading.
- For details about available paper sizes and types for each paper tray, see page 36 "Paper Size Specifications" and page 38 "Paper Type Specifications".
- Depending on the environment where the printer is being used, you might at times hear a rustling noise from paper moving through the printer. This noise does not indicate a malfunction.

Unusable Paper

To prevent errors and misfeeds, do not use:

- Paper for inkjet printers, thermal fax paper, art paper, paper with perforated lines, hemmed-edge paper, OHP transparencies, and window envelopes
- Bent, folded, or creased paper, perforated paper, slippery paper, torn paper, rough paper, thin paper with little stiffness, and paper with a dusty surface

Note

- Errors can occur if you print onto sides that are already printed. Be sure to print onto blank sides only.

- Even supported types of paper may cause paper jams or malfunctions if they have been improperly stored.
- If you print onto rough grain paper, the output image might be blurred.
- Do not load sheets that have already been printed by another printer.

Paper Storage

When storing paper, the following precautions should always be followed:

- Do not store paper where it will be exposed to direct sunlight.
- Avoid storing paper in humid areas (humidity: 70% or less).
- Store on a flat surface.
- Do not store paper vertically.
- Once opened, store paper in plastic bags.

Print Area

The following shows the recommended print area for paper printed with this printer:

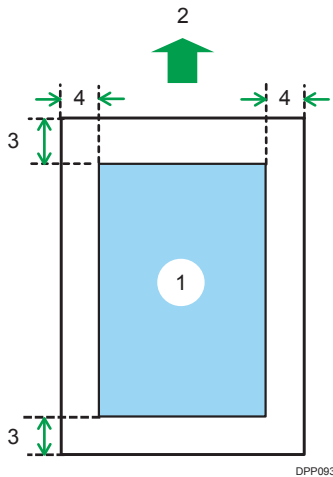

1. Print area
2. Feed direction
3. 4.2 mm (0.2 inches)
4. 4.2 mm (0.2 inches)

Note

- The print area may vary depending on the paper size, printer language, and printer driver settings.
- Depending on the printer driver settings, you may be able to print outside the recommended print area. However, the actual output may not come out as desired, or a paper feed problem may occur.

- To print on paper that is over 900 mm (35.5 inches) in length, set the top margin to at least 4.2 mm (0.2 inches), the right and left margin to at least 10 mm (0.4 inches), and the bottom margin to at least 10 mm (0.4 inches).
- Borderless printing is not supported.

Loading Paper into Paper Trays

In the following example procedure, paper is loaded into Tray 1.

⚠ CAUTION

- When loading paper, take care not to trap or injure your fingers.

★ Important

- For details about trays that can be loaded for each paper size and type, see page 36 "Paper Size Specifications" and page 38 "Paper Type Specifications".
 - Be sure to select the correct paper size and feed direction using the paper size dial on the tray. Otherwise, the printer might be damaged, or printing problems might occur.
 - Make sure the paper stack does not exceed the upper limit mark inside the paper tray. Excessive stacking can cause paper jams.
 - If paper jams occur frequently, flip the paper stack in the tray.
 - Do not mix different types of paper in the same paper tray.
 - After loading paper, specify the paper size using the control panel or paper size dial, and paper type using the control panel. When printing a document, specify the same paper size and type in the printer driver as specified on the printer.
 - Do not move the side paper guides and end paper guide forcefully. Doing so may damage the tray.
 - Do not slide the paper tray in forcefully when inserting the loaded tray into the printer. Otherwise, the side and end guides or the paper guide of the bypass tray might move.
 - When loading label paper, load it one by one.
1. Pull the tray carefully until it stops, lift the front side of the tray, and then pull it out of the printer.

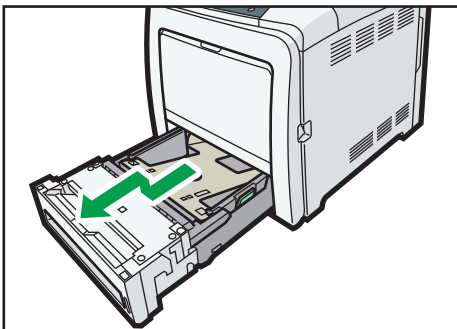

DPP042

Place the tray on a flat surface.

2. Push the metal plate down until it clicks into place to lock.

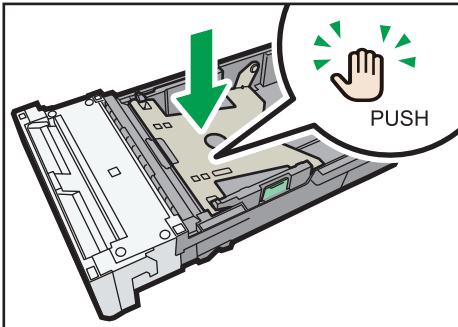

DPP043

3. Squeeze the clip on the side paper guide and slide it to match the paper size.

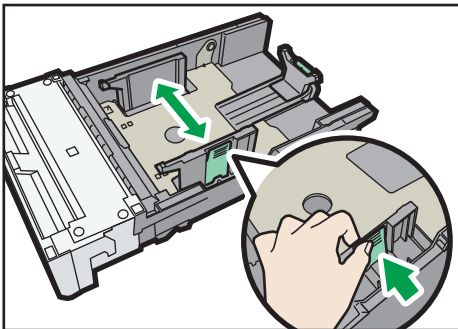

DPP044

When loading custom size paper, position the paper guide slightly wider than the actual paper size.

4. Squeeze the end guide and slide it inward to match the standard size.

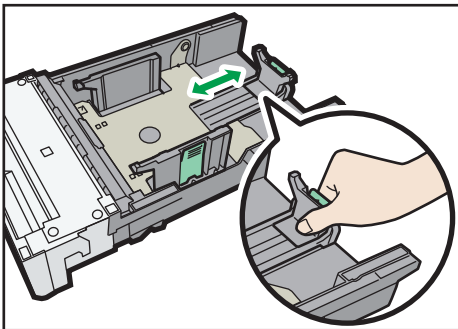

DPP045

5. Load the new paper stack print side up.

Make sure paper is not stacked higher than the upper limit (upper line) marked inside the tray.

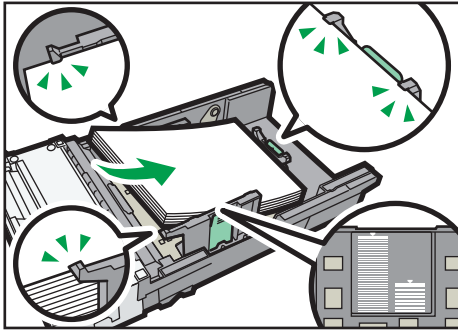

DPP046

6. Adjust the paper guides to close any gaps.

Make sure there is no gap between the paper and the side/end paper guides.

If there is a gap, adjust the side/end paper guides.

Be careful not to press the paper guides against the paper too tightly. Doing so may cause paper misfeeds.

Do not move the loaded paper excessively in the paper tray. Doing so may cause the corners of the paper to catch in the gap at the bottom of the tray, resulting in a paper jam or curled corners.

7. Lift the front side of the tray, and then slide it into the printer carefully until it stops.

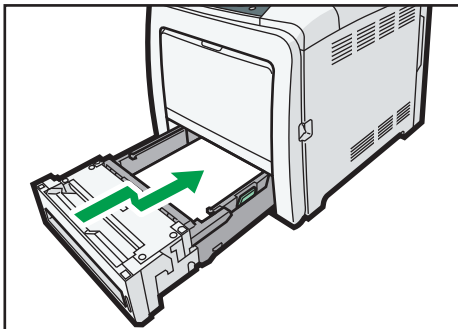

DPP047

To avoid paper jams, make sure the tray is securely inserted.

↓ Note

- Letterhead paper must be loaded in a specific orientation. For details, see page 51 "Loading Orientation-Fixed Paper or Two-Sided Paper".

When Loading Paper Larger than A4 or 8¹/₂ × 11

When loading paper longer than 297 mm into Tray 1, extend the tray.

1. Remove the rear cover using a coin.

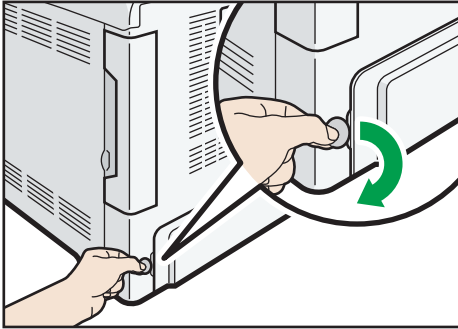

DPP048

2. Pull the tray carefully until it stops, lift the front side of the tray, and then pull it out of the printer.

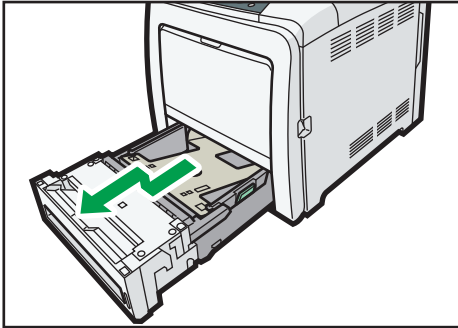

DPP042

Place the tray on a flat surface.

3. Push the metal plate down until it clicks into place to lock.

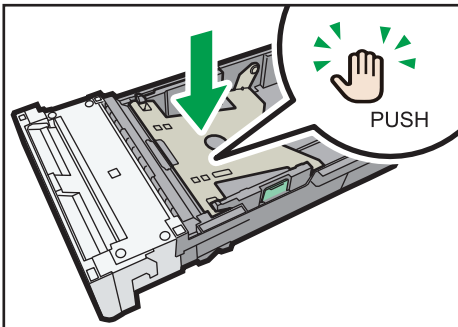

DPP043

4. Squeeze the extender in the "PUSH" direction, and then pull out the extender until it stops (you will hear a click).

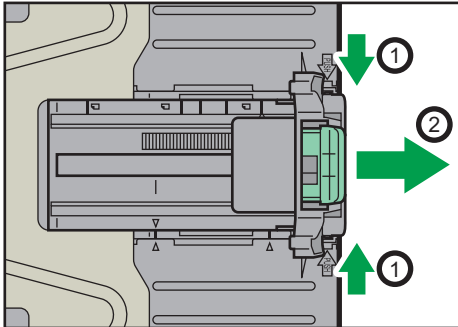

DPP049

After extension, make sure the arrows on the extender and tray are aligned.

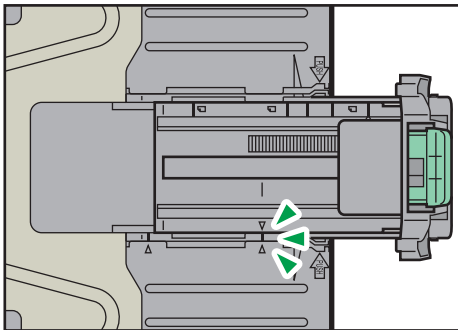

DPP050

5. Squeeze the clip on the side paper guide, and then slide it to match the legal paper size.

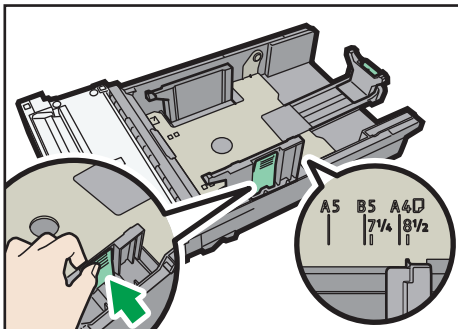

DPP051

When loading custom size paper, position the paper guide slightly wider than the actual paper size.

6. Squeeze the front end paper guide and slide it inward to match the legal paper size.

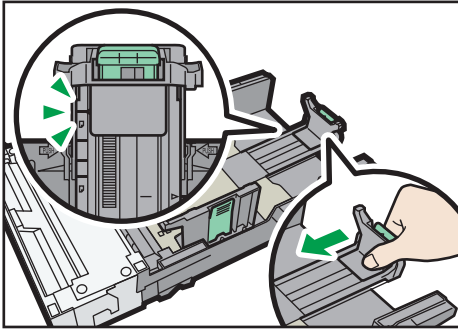

DPP052

Note

- When loading A4, 8 1/2 × 11, or smaller paper, do not extend the tray. Otherwise, a paper jam may occur.

Loading Paper into the Bypass Tray

★ Important

- For details about trays that can be loaded for each paper size and type, see page 36 "Paper Size Specifications" and page 38 "Paper Type Specifications".
 - Make sure the paper stack does not exceed the upper limit mark. Excessive stacking can cause paper jams.
 - Do not mix different types of paper.
 - After loading paper, specify the paper size and type using the control panel. When printing a document, specify the same paper size and type in the printer driver as specified on the printer.
 - When loading label paper, load it one by one.
 - When printing on paper that is longer than A4[□], load only a single sheet of paper on the bypass tray at a time, and hold the paper so it is fed correctly. Also, make sure to check in advance the print quality of the type of paper you intend to use. How paper is fed or print quality will be differs depending on the type or thickness of paper.
1. While pressing and holding the bypass tray open lever in the upper center of the bypass tray, pull the tray open.

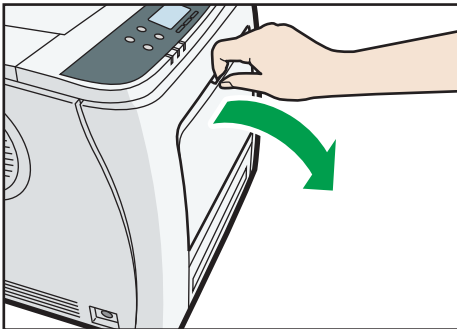

DPP053

Pull the extender out when loading paper larger than A4[□] or 8¹/₂ × 11[□].

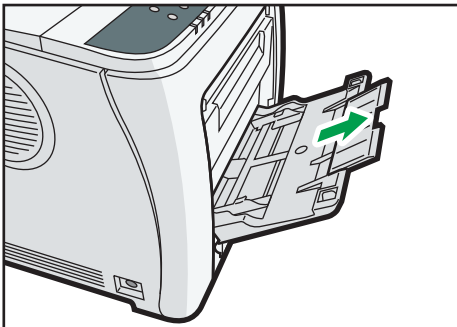

DPP054

2. Slide both sides of the paper guide outward, and then load paper print side up until it stops.
3. Slide both sides of the paper guide outward, and then load paper print side down until it stops.

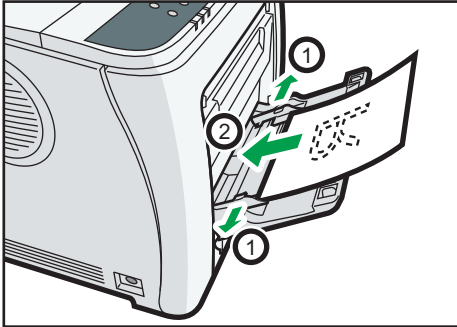

4. Adjust both sides of the paper guide to match the paper width.

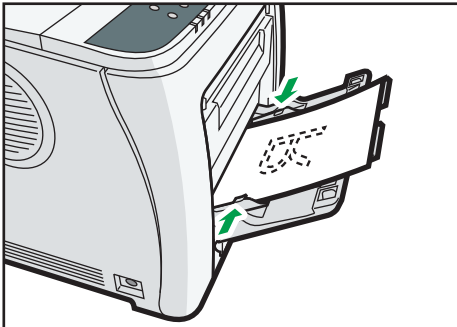

Note

- When using the bypass tray, it is recommended that you set the paper direction to .
- Before loading Postcard or 148 × 200 mm paper, straighten any curls within 2 mm (0.1 inch) upward and 0 mm (0 inches) downward on the tray.
- Letterhead paper must be loaded in a specific orientation. For details, see page 51 "Loading Orientation-Fixed Paper or Two-Sided Paper".
- You can load envelopes into the bypass tray. Envelopes must be loaded in a specific orientation. For details, see page 53 "Loading Envelopes".

Loading Orientation-Fixed Paper or Two-Sided Paper

Orientation-fixed (top to bottom) or two-sided paper (for example, letterhead paper, punched paper, or copied paper) might not print correctly, depending on how the paper is placed.



Settings using the control panel





Set [Letterhead Setting] to [Auto Detect] or [On (Always)], and then place the paper as shown in the table below. For details about [Letterhead Setting], see:

- "Machine Modes (SP C340DN)", Operating Instructions.
- "System (SP C340DN)", Operating Instructions.

Paper orientation

The meanings of the icons are as follows:

Icon	Meaning
	Place or load paper printed side face up.
	Place or load paper printed side face down.

Print side	Trays 1–2	Bypass tray
One-sided		
Two-sided		

Note

- To print on letterhead paper when [Letterhead Setting] is set to [Auto Detect], you must specify [Letterhead] for the paper type in the printer driver's settings.
- If a print job is changed partway through printing from one-sided to two-sided printing, one-sided output after the first copy may be printed facing a different direction. To ensure all paper is output facing the same direction, specify different input trays for one-sided and two-sided printing. Note also that two-sided printing must be disabled for the tray specified for one-sided printing.

- For details about how to make two-sided prints, see "Printing on Both Sides of a Page", Operating Instructions.

Loading Envelopes

This section explains various details about and recommendations concerning envelopes.

⚠ CAUTION



- The inside of the machine could be very hot. Do not touch the parts with a label indicating the "hot surface." Otherwise, an injury might occur.
- Some of this machine's internal components get very hot. For this reason, take care when removing misfed paper. Not doing so could result in burns.

★ Important

- Do not use window envelopes.
- Envelopes, especially those with glue on their flaps, may stick together. Fan the envelopes to separate them before loading. If the envelopes still stick together, load them one by one. For the envelope types that can be used with this printer, see page 36 "Paper Size Specifications" and page 38 "Paper Type Specifications".
- Misfeeds might occur depending on the length and shape of the flaps.
- Load envelopes with their flaps open. Load envelopes with their flaps closed only when the flaps are closed at the time of purchase.
- Before loading envelopes, press down on them to remove any air from inside, flattening out all four edges. If they are bent or curled, flattening their leading edges (the edge going into the printer) by running a pencil or ruler across them.

Loading orientation for envelopes

The method for loading envelopes varies depending on the orientation of the envelopes. Be sure to load envelopes with the correct orientation.

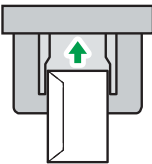
Orientation	Bypass tray
<p data-bbox="395 1348 522 1379">Envelopes </p> 	 <ul style="list-style-type: none"> • Flaps: close • Bottom side of envelopes: toward the right of the printer • Side to be printed: face down

When loading envelopes, use both the control panel and the printer driver to select "Envelope" for the paper type and specify the thickness of the envelopes. For details, see page 54 "Printing on Envelopes with Windows (PCL 6/PostScript 3)", page 55 "Printing on Envelopes with Windows (PCL 5c)", or page 56 "Printing on Envelopes with Mac OS X".

Recommended envelopes

For details about recommended envelopes, contact your local dealer.

The size of envelopes that you can load depends on the tray in which you load them. For details, see page 36 "Paper Size Specifications".

Note

- Load only one size and type of envelope at a time.
- The duplex function cannot be used with envelopes.
- Straighten any curls within 5 mm (0.2 inch) upward and 0 mm (0 inches) downward on the tray before loading.
- To achieve better output quality, it is recommended that you set the right, left, top, and bottom print margin to at least 15 mm (0.6 inches) each.
- The output quality on envelopes may be uneven if parts of an envelope have differing thicknesses. Print one or two envelopes to check the print quality.
- When printing onto envelopes, the print speed is slower than usual.
- Flatten out prints if they are creased or curled.
- Check that the envelopes are not damp.
- High temperature and high humidity conditions can reduce print quality and cause envelopes to become creased.
- Depending on the environment, printing on envelopes may wrinkle them even if they are the recommended envelopes.
- Certain types of envelopes might be output creased, dirtied, or misprinted. If you are printing a solid color on an envelope, lines may appear where the overlapped edges of the envelope make it thicker.

Printing on Envelopes with Windows (PCL 6/PostScript 3)

1. After creating a document, open the [Printing Preferences] dialog box in the document's native application.
2. Click the Detailed Settings tab.

3. In the "Menu:" box, click the Basic icon, and then configure the following settings:

- Document Size:
Select the envelope size.

4. In the "Menu:" box, click the Paper icon, and then configure the following settings:

- Input Tray:
Select the bypass tray.
- Paper Type:
Select [Envelope].

Change any other print settings as necessary. For details, see the printer driver's Help.

5. Click OK.

6. Start printing from the application's [Print] dialog box.

Note

- Configure the paper settings appropriately using both the printer driver and the control panel. For details about settings using the control panel, see page 59 "Configuring Envelope Settings Using the Control Panel".
- Envelopes must be loaded in a specific orientation. For details, see page 53 "Loading Envelopes".

Printing on Envelopes with Windows (PCL 5c)

1. After creating a document, open the [Printing Preferences] dialog box in the document's native application.

2. Click the Paper tab, and then configure the following settings:

- Input Tray:
Select the bypass tray.
- Document Size:
Select the envelope size.
- Type:
Select [Envelope].

Change any other print settings as necessary. For details, see the printer driver's Help.

3. Click OK.

4. Start printing from the application's [Print] dialog box.

Note

- Configure the paper settings appropriately using both the printer driver and the control panel. For details about settings using the control panel, see page 59 "Configuring Envelope Settings Using the Control Panel".
- Envelopes must be loaded in a specific orientation. For details, see page 53 "Loading Envelopes".

Printing on Envelopes with Mac OS X

1. After creating a document, open the printing preferences screen in the document's native application.
2. Configure the following settings:

- Two-Sided:
Clear the check box.
- Paper Size:
Select the envelope size.
- Orientation:
Select the orientation of the envelope.

3. Select [Paper Feed] in the pop-up menu.
4. Select the bypass tray.
5. Select [Printer Features] in the pop-up menu.
6. Switch the "Feature Sets:" menu to configure the following settings:

- Paper Type:
Select [Envelope].

7. Change any other print settings as necessary.
8. Start printing from the application's printing preferences screen.

Note

- Configure the paper settings appropriately using both the printer driver and the control panel. For details about settings using the control panel, see page 59 "Configuring Envelope Settings Using the Control Panel".
- Envelopes must be loaded in a specific orientation. For details, see page 53 "Loading Envelopes".

Paper Settings

This section explains how to specify paper size and type using the control panel.

↓ Note

- When [Tray Setting Priority] is set to [Machine Setting(s)], the paper settings configured using the printer's control panel have priority over the settings specified in the printer driver or commands. For details, see:
 - "Machine Modes (SP C340DN)", Operating Instructions.
 - "System (SP C342DN)", Operating Instructions.

2

Specifying a Paper Size

★ Important

- To use custom size paper, be sure to specify the paper size using the control panel and the printer driver.
- The printer cannot print on custom size paper if the application does not support custom size paper.

Specifying Standard Size Paper

SP C340DN

Press the [Menu] key, and then select the setting items using the [▼] or [▲] key.

1. Select [Paper Input] ▶ Press [OK]
2. Select [Paper Size: (tray name)] ▶ Press [OK]
3. Select the size of the paper set in the specified tray ▶ Press [OK]

SP C342DN

1. Press the [User Tools] key, and then display the [Tray Paper Settings] screen.

[System Settings] ▶ [Tray Paper Settings]

2. Specify the paper size and feed direction.

[Tray Paper Size: (tray name)] ▶ Select the paper size and feed direction ▶ [OK]

↓ Note

- For details about the available paper size, see page 36 "Paper Size Specifications".

Specifying Custom Size Paper

SP C340DN

Press the [Menu] key, and then select the setting items using the [▼] or [▲] key.

1. Select [Paper Input] ▶ Press [OK]
2. Select [Paper Size: (tray name)] ▶ Press [OK]
3. Select [Custom Size] ▶ Press [OK]
4. Enter the horizontal value ▶ Press [OK]
5. Enter the vertical value ▶ Press [OK]

SP C342DN

1. Press the [User Tools] key, and then display the [Tray Paper Settings] screen.

[System Settings] ▶ [Tray Paper Settings]

2. Specify the paper size and feed direction.

[Tray Paper Size: (tray name)] ▶ [Custom Size] ▶ [Vertical] ▶ Enter the vertical dimension of the paper ▶ [OK] ▶ [Horizontal] ▶ Enter the horizontal dimension of the paper ▶ [OK]

3. Press [OK] twice.

ⓘ Note

- For details about the available paper size, see page 36 "Paper Size Specifications".

Specifying a Paper Type

You can improve printer performance by selecting the optimum paper type for the tray.

SP C340DN

Press the [Menu] key, and then select the setting items using the [▼] or [▲] key.

1. Select [Paper Input] ▶ Press [OK]
2. Select [Paper Type: (tray name)] ▶ Press [OK]
3. Select the type of the paper set in the specified tray ▶ Press [OK]
4. If you have selected [Letterhead] for the paper type, press [Escape]
5. Select [Maintenance] ▶ Press [OK]
6. Select [General Settings] ▶ Press [OK]
7. Select [Paper Input] ▶ Press [OK]

8. Select [Paper Type:Bypass] ▶ Press [OK]

SP C342DN

1. Press the [User Tools] key, and then display the [Tray Paper Settings] screen.

[System Settings] ▶ [Tray Paper Settings]

2. Press [Paper Type: Bypass], and then specify the paper type and thickness.

- [Paper Type]
Select the paper type ▶ [OK]
- [Paper Thickness]
Select the paper thickness ▶ [OK]

↓ Note

- For details about the available paper type, see page 38 "Paper Type Specifications".

Configuring Envelope Settings Using the Control Panel

When printing on envelopes, load envelopes in bypass tray or Tray 1, and then follow the procedure below to specify envelope type and thickness.

SP C340DN

Press the [Menu] key, and then select the setting items using the [▼] or [▲] key.

1. Select [Paper Input] ▶ Press [OK]
2. Select [Paper Size: Bypass Tray] ▶ Press [OK]
3. Select the envelope type ▶ Press [OK]
4. Select [Paper Type: Bypass Tray] ▶ Press [OK]
5. Select [Envelope] ▶ Press [OK]

SP C342DN

1. Press the [User Tools] key, and then display the [Tray Paper Settings] screen.

[System Settings] ▶ [Tray Paper Settings]

2. Press [Printer Bypass Paper Size], and then specify the paper size.

Select the envelope size ▶ [OK]

3. Press [Paper Type: Bypass Tray], and then specify the paper type and thickness.

- [Paper Type]
[Envelope] ▶ [OK]
- [Paper Thickness]
[Plain Paper 66-74g/m²] ▶ [OK]

Note

- For details about the envelope types that can be loaded in each tray, see page 36 "Paper Size Specifications" and page 38 "Paper Type Specifications".
- For details about how to load envelopes, see page 53 "Loading Envelopes".
- Configure the paper settings appropriately using both the printer driver and the control panel. For details about paper settings using the printer driver, see page 54 "Printing on Envelopes with Windows (PCL 6/PostScript 3)", page 55 "Printing on Envelopes with Windows (PCL 5c)", or page 56 "Printing on Envelopes with Mac OS X".

3. Troubleshooting

This chapter provides solutions to common problems and it also explains how to correct unwanted print results.

When a Panel Tone Beeps

The following table describes various beep patterns that the printer produces to alert users about printer conditions and the meaning of each beep pattern.

Beep pattern	Meaning	Causes
Single short beep	Panel/screen input accepted.	A control panel key was pressed.
Two long beeps	Printer has warmed up.	When the power is turned on or the printer exits Sleep mode, the printer has fully warmed up and is ready for use.
Single long beep	Job completed.	A Printer job has finished.
Four long beeps	Printer initialized.	The screen is changing back to the initial screen after the printer came out of the energy-saving mode or was reset.
Five short beeps repeated five times.	Strong alert	The printer requires user attention because paper has jammed, the toner needs replenishing, or other problems have occurred.

Note





- Beep alerts cannot be muted. If the printer's covers are opened and closed repeatedly within a short space of time during an alert indicating a paper jam or insufficient toner, a beep alert might continue, even after normal status has resumed.
- You can enable or disable beep alerts. For details, see:
 - "General Settings (SP C340DN)", Operating Instructions.
 - "General Features (SP C342DN)", Operating Instructions.

When Checking the Indicator Lamps, Status Icons, and Messages on the Control Panel

Indicators

This section describes the indicators displayed when the printer requires the user to remove misfed paper, to add paper, or to perform other procedures.

3

Indicator	Status
 : Paper Misfeed indicator	Appears when a paper misfeed occurs. For details about removing jammed paper, see page 114 "Removing Jammed Paper".
 : Load Paper indicator	Appears when paper runs out. For details about loading paper, see page 35 "Loading Paper".
 : Add Toner indicator	Appears when toner runs out. For details about adding toner, see "Replacing the Print Cartridge", Operating Instructions.
 : Service Call indicator	Appears when the printer is malfunctioning or requires maintenance.
 : Cover Open indicator	Appears when one or more covers of the printer are open.

Checking Printer Status and Settings

This function is available for SP C342DN only.

Maintnc. Info

You can check the following items under [Maintnc. Info]:

- Remaining Toner
Displays the amount of remaining toner.
- Paper Tray
Displays the paper type and size loaded into the paper tray.
- Waste Toner Bottle
Displays the state of use of the waste toner bottle.
- Fusing Unit

Displays the state of use of the fusing unit.

- Intermediate Transfer Unit

Displays the state of use of the intermediate transfer unit.

- Output Tray Full

Displays whether the output tray is overloaded.

- Paper Misfeed

Displays the state of and solutions for paper misfeeds.

- Cover Open

Indicates whether one or more covers of the printer are open.

Data Storage

You can check the following items under [Data Storage]:

- HDD Remaining Mem.

Displays the amount of available hard disk memory.

- HDD File(s)

Displays the total number of jobs stored on the hard disk.

- Print Job(s)

Displays the number of jobs for "Hold Print Job(s):", "Stored Print Job(s):", "Locked Print Job(s):", and "Sample Print Job(s):".

Machine Adres Info

You can check the following items under [Machine Adres Info]:

- Machine IPv4 Address

Displays the printer's IPv4 address.

- Machine IPv6 Address

Displays the printer's IPv6 address.

Inquiry

- Machine Repairs
- Sales Representative

1. Press the [Check Status] key, and then check the contents.

[Maintnc/MaInfo] tab ▶ Each key ▶ Check the contents ▶ [Exit]

Note

- [Paper Misfeed], [Output Tray Full], and [Cover Open] appear on [Maintnc. Info] only when these errors occur.
- Depending on the security settings, [Machine Adres Info] might not be displayed.

- For details about how to locate and remove misfeeds, see page 114 "Removing Jammed Paper".

When the Indicator Lamp for the [Check Status] Key Is Lit or Flashing

This function is available for SP C342DN only.

If an indicator for the [Check Status] key lights up, press the [Check Status] key to display the [Check Status] screen. Check the status of the printer in the [Check Status] screen.

[Check Status] screen

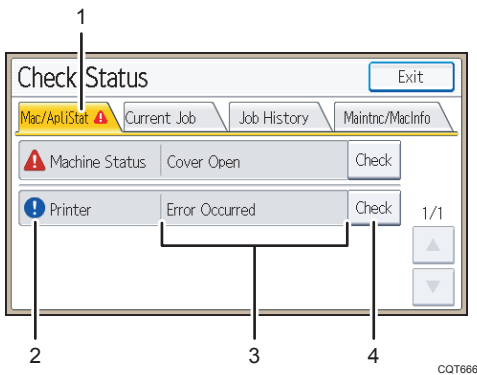

1. [Mac/AplStat] tab

Indicates the status of the printer.

2. Status icons

The icons that can be displayed are described below:

: The printer function is performing a job.

: An error has occurred on the printer.

: An error has occurred in the printer function being used, or the printer function cannot be used because an error has occurred on the printer.

3. Messages

Displays a message that indicates the status of the printer. This icon may also appear if the toner is running low.

4. [Check]

If an error occurs, press [Check] to view details.

Pressing [Check] displays an error message or the printer screen. Check the error message displayed on the printer screen and take the appropriate action. For details about error messages and their solutions, see page 67 "When Messages Are Displayed".

The following table describes problems that cause the indicator to light:

Problem	Cause	Solution
Documents and reports do not print out.	The paper output tray is full.	Remove the prints from the tray.
Documents and reports do not print out.	There is no paper left.	Load paper. For details about loading paper, see page 35 "Loading Paper".
An error has occurred.	A function that has the status "Error Occurred" in the [Check Status] screen is defective.	Press [Check], and then check the displayed message and take appropriate action. For details about error messages and their solutions, see page 67 "When Messages Are Displayed".
The printer is unable to connect to the network.	A network error has occurred.	<ul style="list-style-type: none"> • Press [Check], and then check the displayed message and take appropriate action. For details about error messages and their solutions, see page 67 "When Messages Are Displayed". • Check that the printer is correctly connected to the network and that the printer is correctly set. For details about how to connect the network, see "Interface Settings", Operating Instructions. • For details about connecting to the network, contact your administrator. • If the indicator is still lit even after trying to solve the problem as described here, contact your service representative.

If USB Connection Fails

Problem	Causes	Solutions
The printer is not automatically recognized.	The USB cable is not connected properly.	Disconnect the USB cable, turn off the printer, and then turn it on again. When the printer has fully booted up, reconnect the USB cable.
Windows has already configured the USB settings.	Check whether or not the computer has identified the printer as an unsupported device.	Open Windows' Device Manager, and then, under [Universal Serial Bus controllers], remove any conflicting devices. A [!] or [?] icon is displayed for conflicting devices. Take care not to accidentally remove required devices. For details, see Windows Help.

When Messages Are Displayed

This section describes the main messages that appear on the display panel and printed error logs and reports. If other messages appear, follow their instructions.

Status Messages

SP C340DN

Message	Status
"@Remote Certif. updating..."	The printer is updating the @Remote certificate. Turn the power off, and then turn it on again.
"Calibrating..."	The printer is calibrating the color. Wait a while.
"Energy Saver Mode"	The printer is in Energy Saver mode. Press any key to recover to the normal mode.
"Hex Dump Mode"	In Hex Dump mode, the printer receives data in a hexadecimal format. Turn off the printer after printing, and then turn it on again.
"Job Suspended"	All jobs are suspended. Turn off the printer, and turn it on again to resume the jobs.
"Offline"	The printer is offline and cannot print.
"Please wait..."	This message may appear for a few seconds. It means the printer is initializing, replenishing toner, or performing maintenance operations. Wait a while.
"Printing..."	The printer is printing. Wait a while.
"Printing Suspended"	Printing is suspended. To resume printing, press the [Suspend/Resume] key.
"Ready"	This is the default ready message. The printer is ready for use. No action is required.
"Resetting Job"	The printer is resetting the print job. Wait a while.
"Setting change..."	The printer is applying the changes made to its settings. Wait a while.
"Waiting for print data..."	The printer is waiting for the next data to print. Wait a while.

SP C342DN

Message	Status
"Calibrating..."	The printer is calibrating the color. Wait a while.
"Hex Dump Mode"	In Hex Dump mode, the printer receives data in a hexadecimal format. Press [Job Reset] to cancel Hex Dump mode.
"Job suspended."	Printing was temporarily suspended because [Job Operation] or the [Suspended] key was pressed.
"Loading Toner..."	The printer is loading the toner. Wait a while.
"Offline"	The printer is offline.
"Please wait."	This message might appear for a second or two while the printer is preparing, performing initial adjustments, or adding toner. Wait a while.
"Printing..."	The printer is printing. Wait a while.
"Ready"	This is the default ready message. The printer is ready for use. No action is required.
"Resetting job..."	The printer is resetting the print job. Wait until "Ready" appears on the display panel.
"Setting change..."	The printer is changing settings. You cannot use the control panel while this message is displayed. Wait a while.
"Updating certif..."	The @Remote certificate is being updated. Wait a while.
"Waitg. for prt.data"	The printer is waiting for the next data to print. Wait a while.

Alert Messages (Displayed on the Control Panel)**SP C340DN**

Message	Cause	Solution
" ! (A) Remove paper from Trays. Opn & cls Frt. Cov."	Open the front cover and remove the jammed paper from the paper feed path.	For details, see page 114 "Removing Jammed Paper".

Message	Cause	Solution
"  (B) Open Front Cover and remove the paper."	Open the front cover and remove the jammed paper from the internal paper feed path.	For details, see page 114 "Removing Jammed Paper".
"  (Y) Remove misfeed in Trays. Opn & cls Frt. Cov."	Open the front cover and remove any jammed paper.	For details, see page 114 "Removing Jammed Paper".
"  (Z) Open Front Cover and remove the paper."	Open the front cover and remove any jammed paper from the paper duplex unit.	For details, see page 114 "Removing Jammed Paper".
"  Out of toner"	The color toner has run out. Replace the toner cartridge.	For details, see "Replacing the Print Cartridge", Operating Instructions.
"  Waste Toner almost full"	The waste toner bottle is almost full.	Contact your sales or service representative to obtain a new waste toner bottle.
"  Waste Toner Bottle full"	Replace the waste toner bottle.	For details, see "Replacing Other Consumables", Operating Instructions.
"@Remote Cert. update failed"	Updating the @Remote certificate failed.	Turn the printer off, and then turn it on again. If the problem persists, contact your sales or service representative.
"Cannot connect=>Comm.Serv. Check proxy user/ password."	The proxy user name or password is incorrect.	Check the proxy server settings, and then change the user name and/or password if they are incorrect.
"Cannot connect with DHCP server.(101/201)"	An IP address cannot be obtained from the DHCP server.	Contact your network administrator.
"Cannot print."	The printer cannot print the sent data.	Check that the file you want to print is a supported file type. Check the misfeeds and ask your network administrator for help.
"Change (Tray name) to the following settings:"	The size of the paper in the tray does not match the paper size specified in the printer driver.	Select a tray containing paper that is the same size as the specified paper size.

Message	Cause	Solution
"Check network settings. (103/203)"	The IP address setting is incorrect.	Check the IP address, subnet mask, and gateway address.
"Classification Code Error"	A classification code is not specified for the print job.	Enter a classification code using the printer properties and print the document again.
"Connect failed:WirelessCard Turn power off, check card."	The printer cannot detect the wireless LAN interface board.	Check that the board is supported or installed correctly.
"Cover Open. Please close the indicated cover."	A cover of the printer is open.	Close the cover as indicated on the control panel.
"Duplex mode is in off position for (tray name)"	The duplex mode for the indicated tray is not available.	You can use one-sided printing only. Press [Change] to change the tray's settings, press [JobReset] to reset the job, or press [Form Feed] to force printing.
"ECO Night Sensor did not turn Power Switch off. Turn switch off manually or to use, press any key."	Auto power off by the [ECO Night Sensor] function failed.	Turn off the power manually, or press any key to use [ECO Night Sensor] auto power off function.
"Ethernet Board Error"	An error on the Ethernet is detected.	Turn the printer off, and then turn it on again. If the problem persists, contact your sales or service representative.
"Failed to connect to server for Remote Diagnostics."	The printer cannot communicate with Remote Communication Gate.	Check the connection to the Remote Server Gate.
"IPv6 Address already exists Link-local Address(109/209)"	The same IPv6 address is already used.	Contact your network administrator.
"IPv6 Address already exists Stateless Address(109/209)"	The same IPv6 address is already used.	Contact your network administrator.

Message	Cause	Solution
"IPv6 Address already exists Manual Config. Address(109/209)"	The same IPv6 address is already used.	Contact your network administrator.
"Load paper in (tray name) or [Cancel] to FormFeed."	There is no paper in the specified tray.	Load the specified paper in the tray, press [JobReset] to reset the job. To print from the bypass tray on paper whose width is less than 84 mm, cancel the print job, and then, under [System], set [Bypass Print: 64-84 mm] to [Active].
"May have exceeded max no. of prints in output tray. Print stopped. Check the tray."	The output tray is full.	Remove paper from the output tray.
"Output Tray is full. Remove paper."	The output tray is full.	Remove the paper.
"Problem: Printer Font Error"	There are problems with the printer's font file.	Turn the printer off, and then turn it on again. If the problem persists, contact your sales or service representative.
"Problem:Wireless board Please call service."	The printer cannot detect a wireless LAN interface board.	Check that the wireless LAN interface board installed correctly. If the problem persists, contact your sales or service representative.
"Replace Fusing Unit."	You will need to replace the fusing unit soon.	Contact your sales or service representative to obtain a new unit.
"Replacemnt Requird:InfTrans"	You need to replace the intermediate transfer unit.	For details, see "Replacing Other Consumables", Operating Instructions.
"Replcmnt Requird: Print Cart"	The toner has run out, or the photo conductor unit has reached the end of its service life.	For details, see "Replacing the Print Cartridge", Operating Instructions.

Message	Cause	Solution
"Replacmnt Rqrd:Fusing Unit"	You need to replace the fusing unit.	For details, see "Replacing Other Consumables", Operating Instructions.
"Replcmnt Rqrd Soon:InfTrans"	You will need to replace the intermediate transfer unit soon.	Contact your sales or service representative to obtain a new unit.
"Repl Rqurd Soon:FusingUnit"	You will need to replace the fusing unit soon.	Contact your sales or service representative to obtain a new unit.
"Sensor cleaning required."	You need to clean the toner density sensor.	For details, see "Cleaning the Toner Density Sensor", Operating Instructions.
"Set the Fusing Unit correctly."	The fusing unit may not be installed correctly. Turn the printer off and re-install the fusing unit. If the message is still displayed after re-installation, contact your sales or service representative.	For details, see "Replacing Other Consumables", Operating Instructions.
"Set the Intermediate Transfer Unit correctly."	The intermediate transfer unit may not be installed correctly. Turn the printer off and re-install the intermediate transfer unit. If the message is still displayed after re-installation, contact your sales or service representative.	For details, see "Replacing Other Consumables", Operating Instructions.
"Set the Print Cartridge correctly."	The print cartridge may have not been installed correctly.	Turn the printer off, and install the print cartridge again.
"Set Waste Toner Bottle correctly."	The waste toner bottle may not be installed correctly. Turn the printer off and re-install the waste toner bottle. If the message is still displayed after re-installation, contact your sales or service representative.	For details, see "Replacing Other Consumables", Operating Instructions.

Message	Cause	Solution
"Supply order has failed."	The automatic supply order failed.	The message indicates the printer tried to order the supplies.
"This NetBIOS name is already in use.(108/208)"	The NetBIOS name specified for the printer is already used by another device on the network.	Contact your network administrator.
"The same IPv4 Address already exists.(102/202)"	The IPv4 address specified for the printer is already used by another device on the network.	Contact your network administrator.
"The selected job has already been printed or deleted."	This message might appear if you print or delete a job from Web Image Monitor.	Press Exit on the message screen.
 Toner is almost empty."	The print cartridge is almost empty.	For details, see "Replacing the Print Cartridge", Operating Instructions.
"USB has a problem. / Please call service."	The printer has detected a USB board failure.	Turn the printer off, and then turn it on again. If the problem persists, contact your sales or service representative.
"Values set for IPv6/ Gateway addresses are invalid.(110/210)"	The IPv6 address or gateway address is invalid.	Check the network settings.
"WPA Auth. incomplete. (211)"	WPA authentication could not be completed.	Contact your network administrator.

SP C342DN

Message	Cause	Solution
"Cannot connect with the wireless card. Turn the main power switch off, then check the card."	<ul style="list-style-type: none"> • The wireless LAN interface board was not inserted when the printer was turned on. • The wireless LAN interface board was pulled out after the printer was turned on. • The settings are not updated although the unit is detected. 	<ul style="list-style-type: none"> • Turn off the main power switch, and then confirm the wireless LAN interface board is inserted correctly. For details about installing the board, contact your service representative. • If the message appears again, contact your service representative.
"Cannot print because both the main and designation (chapter) sheets are set to the same paper tray. Press [Job Reset] to cancel the job."	The tray selected for other pages is the same as the one for slip sheets.	Reset the job. Be sure the tray you select for slip sheets is not providing paper for other pages.
"Change the setting to continue the current job or press [Job Reset]."	The size of the paper in the tray does not match the paper size specified in the printer driver.	Check that the printer driver settings are correct, and then change the paper size or cancel printing.
"Failed to update @Remote certificate. Please call service."	Updating the @Remote certificate failed.	Turn the printer off, and then turn it on again. If the problem persists, contact your sales or service representative.
"Hardware Problem: Ethernet"	An error has occurred in the Ethernet interface.	Turn the main power switch off and then back on again. If the message appears again, contact your service representative.

Message	Cause	Solution
"Hardware Problem: HDD"	An error has occurred in the hard disk.	<ul style="list-style-type: none"> • Turn the main power switch off and then back on again. If the message appears again, contact your service representative. • The hard disk may have not been installed properly if you have installed it yourself. Check that it is properly installed For details about installing the unit, see "Installing the Hard Disk", Operating Instructions.
"Hardware Problem: Parallel I/F"	An error has occurred in the IEEE 1284 interface board.	<ul style="list-style-type: none"> • Turn the main power switch off and then confirm the IEEE 1284 interface board is inserted correctly. For details about installing the board, see "Installing the Interface Units", Operating Instructions. • If the message appears again, contact your service representative.
"Hardware Problem: USB"	An error has occurred in the USB interface.	Turn the main power switch off and then back on again. If the message appears again, contact your service representative.

Message	Cause	Solution
<p>"Hardware Problem: Wireless Card"</p> <p>(A "wireless LAN interface board" is referred to as a "wireless card".)</p>	The wireless LAN interface board can be accessed, but an error was detected.	<ul style="list-style-type: none"> • Turn off the main power switch, and then confirm the wireless LAN interface board is inserted correctly. For details about installing the board, see "Installing the Interface Units", Operating Instructions. • If the message appears again, contact your service representative.
"Load ppr blw in (Tray name)."	The printer driver settings are incorrect or the tray does not contain paper of the size selected in the printer driver.	Check that the printer driver settings are correct, and then load paper of the size selected in the printer driver into the input tray. For details about how to change the paper size, see page 35 "Loading Paper".
"No toner. Replace Toner Cartridge."	The toner has run out. Replace the print cartridge.	For details, see "Replacing the Print Cartridge", Operating Instructions.
"No color toner. Color toner is required to print in black & white with the current paper type. Replace the color Print Cartridge or press [Job Reset] to cancel printing."	The color toner has run out. Replace the print cartridge.	For details, see "Replacing the Print Cartridge", Operating Instructions.
"n ppr siz msmtch Select new tray or use ppr size below." ("n" is a tray name.)	The size of the paper in the tray does not match the paper size specified in the printer driver.	Select a tray containing paper that is the same size as the specified paper size.
"Printer font error."	An error has occurred in the font settings.	Contact your service representative.

Message	Cause	Solution
"Problems with the wireless board. Please call service." (A "wireless LAN interface board" is referred to as a "wireless board".)	The printer has detected a wireless LAN interface board failure.	If the message appears again, contact your service representative.
"Output Tray is full. Remove paper."	The output tray is full.	Remove the paper.
"Replacement of Fusing Unit is now necessary. Please call service."	You need to replace the fusing unit.	For details, see "Replacing Other Consumables", Operating Instructions.
"Fusing Unit must be replaced now. Replace Fusing Unit."	You need to replace the fusing unit.	For details, see "Replacing Other Consumables", Operating Instructions.
"Replacement of Fusing Unit will soon be necessary. A new unit is required. Please contact your local vendor."	You will need to replace the fusing unit soon.	Contact your sales or service representative to obtain a new unit.
"Replacement of Transfer Unit is now necessary. Replace Transfer Unit."	You need to replace the intermediate transfer unit.	For details, see "Replacing Other Consumables", Operating Instructions.
"Replacement of Transfer Unit is now necessary. Replace Transfer Unit."	You need to replace the intermediate transfer unit.	For details, see "Replacing Other Consumables", Operating Instructions.
"Replacement of Transfer Unit will soon be necessary. A new unit is required. Please contact your local vendor."	You will need to replace the intermediate transfer unit soon.	Contact your sales or service representative to obtain a new unit.
"Sensor cleaning required."	You need to clean the toner density sensor.	For details, see "Cleaning the Toner Density Sensor", Operating Instructions.

Message	Cause	Solution
"SD Card authentication has failed. Please call service."	Authentication from the SD card failed.	Turn the printer off, and then turn it on again. If the problem persists, contact your sales or service representative.
"Tray setg. do not match spcfd siz&typ. Select new tray or use siz&typ below."	The printer driver settings are incorrect or the tray does not contain paper of the size or type selected in the printer driver.	<ul style="list-style-type: none"> • Check that the printer driver settings are correct, and then load paper of the size selected in the printer driver into the input tray. For details about how to load paper, see page 35 "Loading Paper". • Select the tray manually to continue printing, or cancel a print job. For details about how to select the tray manually, or cancel a print job, see "If an Error Occurs with the Specified Paper Size and Type", Operating Instructions.
"Waste Toner Bottle is full. Replace the bottle."	The waste toner bottle is full.	Replace the waste toner bottle. For details, see "Replacing Other Consumables", Operating Instructions.

Messages during Direct print from a memory storage device

Message	Causes	Solutions
"Unable to access the specified memory storage device."	The memory device used cannot be recognized.	For details about the recommended memory devices for the Direct printing function from memory storage devices, contact your service representative. The USB flash memory device that features password protection or other security features may not work normally.

Alert Messages (Printed on Error Logs and Reports)

This section describes likely causes of and possible solutions for the error messages that are printed on the error logs or reports.

SP C340DN

Message	Cause	Solution
"Address book is in use."	The printer currently cannot perform authentication because the Address Book is being used by another function.	Wait a while, and then retry the operation.
"Auto-user prog. failed."	Automatic registration of information for LDAP Authentication or Windows Authentication failed because the Address Book is full.	For details about the automatic registration of user information, see "Auto Registration to the Address Book", Security Guide.
"Cannot print."	You have no privileges to print the PDF file you want to print.	Contact the owner of the document.
"Classification Code Error"	The classification code is not specified with the printer driver.	Select [Optional] for the classification code. For details about how to specify classification code settings, see "Registering Classification Codes", Operating Instructions.
"Collate cancelled."	Collate was canceled.	Turn the printer off, and then turn it on again. If the message appears again, contact your service representative.
"Collate: Page max."	The amount of free memory is insufficient to perform collating.	Reduce the number of pages to be printed.
"Command Error."	An RPCS command error occurred.	Check that the communication between a device and the printer is working correctly.
"Compressed Data Error"	The printer detected corrupt compressed data.	Check that the program you used to compress the data is functioning correctly.

Message	Cause	Solution
"Duplex cancelled."	Duplex printing was canceled.	Change the setting for "Duplex Tray" in [Paper Input] to enable duplex printing for the paper tray.
"Error occured. Prntd/Cncl."	An error occurred during printing, but it was ignored.	Check the print settings.
"Excd Prt Vol Use max count."	Printing was canceled because the print maximum number was reached.	Contact your user administrator.
"Excd Prt Vol Use max count."	Maximum number of user codes that can be registered has been reached.	Delete unnecessary user codes.
"File System Error."	PDF direct printing could not be performed because the file system could not be obtained.	Turn the printer off, and then turn it on again. If the message appears again, contact your service representative.
"File System Full."	The PDF file cannot be printed because the capacity of the file system is full.	Delete all unnecessary files from the hard disk, or decrease the file size sent to the printer.
"Function use denied."	The print job was cancelled because of one of the following: <ul style="list-style-type: none"> • The user does not have privileges to print. • No privileges to print are assigned to the entered user name or user code, or • A wrong password was specified for the user name. 	Enter the user name or user code with privileges to print, or enter the correct password for the user name.

Message	Cause	Solution
"I/O buffer overflow."	An input buffer overflow occurred.	<ul style="list-style-type: none"> • Select [Font Priority] for [Memory Usage] in [System]. • In [I/O Buffer] under the [Host Interface] menu, set the maximum buffer size to a larger value. • Reduce the number of files being sent to the printer.
"No response from server."	A timeout occurred while the printer was connecting to the server for LDAP Authentication or Windows Authentication.	Check the status of the server.
"Paper Size Error"	Printing was canceled because the specified paper size cannot be fed from the tray.	Check the available paper size.
"Paper Type Error"	The printer does not recognize the paper type specified using the printer driver.	Check that the printer is connected to the network correctly and bidirectional communication is enabled. If the problem persists, check the user paper type settings of the printer.
"Password mismatch."	A wrong password was entered when an encrypted PDF file was printed.	Check the password.
"PDF File Error."	A syntax error, etc., occurred.	Check that the PDF file is valid.
"Print overrun."	Printing images was aborted.	Select a lower resolution on the printer driver. For details about how to change the resolution setting, see the printer driver Help.
"Receiving data failed."	Data reception was aborted.	Resend the data.
"Sending data failed."	The printer received a command to stop a transmission from the printer driver.	Check that the computer is working correctly.

Message	Cause	Solution
"User auth. already exists."	The same account name is already used in the newly selected domain or server in an environment using LDAP Authentication or Integration Server Authentication.	Contact your user administrator.

SP C342DN

Message	Cause	Solution
"98: Error"	The printer could not access the hard disk correctly.	Turn the main power switch off and then back on again. If the message appears frequently, contact your service representative.
"AN: A job via the network that was not printed exists because an error occurred. It was stored as a job not printed."	Jobs with errors were stored because an error occurred with a print job via the network while the error job storing function was enabled.	Contact your administrator to check whether the machine is connected correctly to the network.
"Address Book is currently in use by another function. Authentication has failed."	The printer currently cannot perform authentication because the Address Book is being used by another function.	Wait a while, and then retry the operation.
"Auto-registration of user information has failed."	Automatic registration of information for LDAP Authentication or Windows Authentication failed because the Address Book is full.	For details about automatic registration of user information, see Security Guide.
"Classification Code is incorrect."	The classification code has not been entered, or the classification code has been entered incorrectly.	Enter the correct classification code.

Message	Cause	Solution
"Classification Code is incorrect."	The classification code is not supported by the printer driver.	Select [Optional] for the classification code. For details about how to specify classification code settings, see "Registering Classification Codes", Operating Instructions.
"Collate has been cancelled."	Collate was canceled.	Decrease the number of files sent to the printer.
"Command Error."	An RPCS command error occurred.	Check that the communication between the digital camera and the printer is working correctly.
"Command Error"	An RPCS command error occurred.	Check that the communication between a device and the printer is working correctly.
"Compressed Data Error."	The printer detected corrupt compressed data.	<ul style="list-style-type: none"> • Check the connection between the computer and the printer. • Check that the program you used to compress the data is functioning correctly.
"Data storage error."	You tried to print a Sample Print, Locked Print, Hold Print, or Stored Print file while the hard disk was not installed.	The hard disk is required when printing a Sample Print, Locked Print, Hold Print, or Stored Print. If the message appear after installing the hard disk, contact your service representative.

Message	Cause	Solution
"Duplex has been cancelled."	Duplex printing was canceled.	<ul style="list-style-type: none"> • Select the proper paper size for the duplex function. For details about paper size, see page 36 "Paper Size Specifications". • Change the setting for "Apply 2 sided" in [System Settings] to enable duplex printing for the paper tray. For details about setting "Apply 2 sided", see "Tray Paper Settings (SP C342DN)", Operating Instructions.
"Error has occurred."	A syntax error, etc., occurred.	Check that the PDF file is valid.
"Error occurred. Either job was printed with settings changed or it was cancelled."	An error occurred during printing, but it was skipped.	Check that the data is valid.
"Exceed max. No. of files to print for temp./stored jobs."	While printing a Sample Print, Locked Print, Hold Print, or Stored Print file, the maximum file capacity was exceeded.	Delete unneeded files stored in the printer.
"Exceed max. No. of files. (AT)"	While using the error job store function to store Normal Print jobs as Hold Print files, the maximum file capacity for file storage or Hold Print file management (automatic) was exceeded.	Delete Hold Print files (automatic) or unneeded files stored in the printer.
"Exceed max. No. of pages(AT)"	While using the error job store function to store Normal Print jobs as Hold Print files, the maximum page capacity was exceeded.	<ul style="list-style-type: none"> • Delete unneeded files stored in the printer. • Reduce the number of pages to print.

Message	Cause	Solution
"Exceeded max. No. of pages for temporary/stored jobs."	While printing a Sample Print, Locked Print, Hold Print, or Stored Print file, the maximum page capacity was exceeded.	<ul style="list-style-type: none"> • Delete unneeded files stored in the printer. • Reduce the number of pages to print.
"Exceeded max. pages. Collate is incomplete."	The number of pages exceeds the maximum number of sheets that can be used with Collate.	Reduce the number of pages to print.
"Exceeded the maximum unit count for Print Volume Use. The job has been cancelled."	The number of pages the user is permitted to print has been exceeded.	For details about Print Volum. Use Limit., see "Managing Print Volume Per User", Security Guide.
"Failed to obtain file system."	PDF direct printing could not be performed because the file system could not be obtained.	Turn off the main power switch and then back on again. If the message appears again, contact your service representative.
"File system is full."	The PDF file does not print out because the capacity of the file system is full.	Delete all unnecessary files from the hard disk, or decrease the file size sent to the printer.
"HDD is full."	The hard disk became full while printing a Sample Print, Locked Print, Hold Print, or Stored Print file.	<ul style="list-style-type: none"> • Delete unneeded files stored in the printer. • Reduce the data size of the Sample Print, Locked Print, Hold Print, or Stored Print file.
"HDD is full."	When printing with the PostScript 3 printer driver, the hard disk capacity for fonts and forms has been exceeded.	Delete unneeded forms or fonts registered in the printer.
"HDD is full. (Auto)"	The hard disk became full while using the error job store function to store Normal Print jobs as Hold Print files.	<ul style="list-style-type: none"> • Delete unneeded files stored in the printer. • Reduce the data size of the Temporary Print file and/or the Stored Print file.

Message	Cause	Solution
"I/O buffer overflow."	An input buffer overflow occurred.	<ul style="list-style-type: none"> • Select [Font Priority] for [Memory Usage] in [System]. • In [I/O Buffer] under the [Host Interface] menu, set the maximum buffer size to a larger value. • Reduce the number of files being sent to the printer.
"Information for user authentication is already registered for another user."	The user name for LDAP Authentication or Integration Server Authentication was already registered in a different server with a different ID, and a duplication of the user name occurred due to a switching of domains (servers), etc.	For details about User Authentication, see "Configuring User Authentication", Security Guide.
"Insufficient Memory"	A memory allocation error occurred.	<p>PCL 5/PostScript 3</p> <p>Select a lower resolution on the printer driver. For details about how to change the resolution setting, see the printer driver Help.</p> <p>PCL 6</p> <p>Select a lower resolution on the printer driver. For details about how to change the resolution setting, see the printer driver Help. On the printer driver's [Detailed Settings] tab, click [Print Quality:Advanced] in "Menu:", and then select [Raster] in the "Vector/Raster:" list. In some cases, it will take a long time to complete a print job.</p>

Message	Cause	Solution
"Memory Retrieval Error"	A memory allocation error occurred.	Turn off the main power switch and then back on again. message appears again.
"No response from the server. Authentication has failed."	A timeout occurred while connecting to the server for LDAP Authentication or Windows Authentication.	Check the status of the server.
"PDL error."	The printer language error occurred.	Press [OK].
"PDL error has occurred. The print job that caused the error will be cancelled."	Printing was canceled because the printer language error occurred.	Resend the data.
"Print overrun."	Images were discarded while printing.	Select a lower resolution on the printer driver. For details about how to change the resolution setting, see the printer driver Help.
"Printing privileges have not been set for this document."	The PDF document you have tried to print has no privileges to print.	Contact the owner of the document.
"Receiving data failed."	Data reception was aborted.	Resend the data.
"The selected paper size is not supported. This job has been cancelled."	Job Reset is automatically performed if the specified paper size is incorrect.	Specify the correct paper size, and then print the file again.
"Sending data failed."	The printer received a command to stop transmission from the printer driver.	Check that the computer is working correctly.
"Supplies order has failed."	The automatic supply order failed.	The message indicates the printer tried to order the supplies.

Message	Cause	Solution
"Unauthd. Copy Preventn. Error"	The [Enter User Text:] field on the [Unauthorized Copy Prevention for Pattern Details] screen is blank.	PCL 6/PostScript 3 On the printer driver's [Detailed Settings] tab, click [Effects] in "Menu:". Select [Unauthorized Copy Prevention], and then click [Details] to display [Unauthorized Copy Prevention for Pattern Details]. Enter text in [Enter User Text:].
"User Paper Type Error"	The printer does not recognize the paper type specified using the printer driver.	Check that the printer is connected to the network correctly and bidirectional communication is enabled. If the problem persists, confirm the user paper type settings of the printer. For details, see "Registering Unique Names to Paper Types", Operating Instructions.
"You do not have a privilege to use this function. This job has been cancelled."	The entered Login User Name or Login Password is not correct.	Check that the Login User Name and Login Password are correct.
"You do not have a privilege to use this function. This job has been cancelled."	The logged in user is not allowed to use the selected function.	For details about how to set permissions, see "Configuring User Authentication", Security Guide.
"You have no privilege to use this func. Operation canceled."	The logged in user does not have the privileges to register programs or change the paper tray settings.	For details about how to set permissions, see "Configuring User Authentication", Security Guide.

Messages during Direct print from a memory storage device

Message	Causes	Solutions
"99: Error"	This data cannot be printed. The specified data is either corrupt or not supported by the Direct printing function from memory storage devices.	Check that the data is valid. For details about the kinds of data supported by the Direct printing function from memory storage devices, see "Direct Printing from a Memory Storage Device", Operating Instructions.

If printing does not start, contact your service representative.

Note

- The contents of errors may be printed on the Configuration Page. Check the Configuration Page in conjunction with the error log. For details about how to print the Configuration Page, see "Test Printing", Operating Instructions.

When You Cannot Print

Problem	Cause	Solution
Printing does not start.	The power is off.	For details about how to turn on the main power switch, see page 26 "Turning On/Off the Power".
Printing does not start.	The cause is displayed on the screen of the control panel.	Check the error message or warning status on the display panel, and then take the required action. For details about solutions, see page 67 "When Messages Are Displayed".
Printing does not start.	The interface cable is not connected correctly.	For details about how to connect interface cables correctly, see "Connecting the Printer", Operating Instructions.
Printing does not start.	The correct interface cable is not being used.	The type of interface cable to use depends on the computer. Be sure to use the correct one. If the cable is damaged or worn, replace it. For details about interface cable, see "Connecting the Printer", Operating Instructions.
Printing does not start.	The interface cable was connected after the printer was switched on.	Connect the interface cable before turning on the main power switch.

Problem	Cause	Solution
Printing does not start.	If the printer is using wireless LAN, failure to print might result from a weak wireless signal.	<p>Check the radio signal status of the wireless LAN in [System Settings]. If the signal quality is not satisfactory, move the printer to a location where radio waves can pass or remove objects that might cause interference.</p> <p>You can check the signal status only when wireless LAN is used in infrastructure mode. For details about the radio signal status of the wireless LAN, see:</p> <ul style="list-style-type: none"> • "Host Interface (SP C340DN)", Operating Instructions. • "Interface Settings (SP C342DN)", Operating Instructions.
Printing does not start.	If the printer is using wireless LAN, when there is a microwave oven, mobile phone, industrial machine, scientific instrument, or medical instrument which uses the same frequency range near the device, radio waves may be interfering with the wireless LAN's communication.	Turn off the microwave oven, mobile phone, industrial machine, scientific instrument, or medical instrument which uses the same frequency range and then try printing again. If printing is successful, move the device to a location where it does not interfere.
Printing does not start.	If the printer is using wireless LAN, SSID settings may be incorrect.	Check that the SSID is correctly set using the printer's display panel. For details about SSID Setting, see "Connecting to the Wireless LAN Interface", Operating Instructions.

Problem	Cause	Solution
Printing does not start.	If the printer is using wireless LAN, the receiver's MAC address may be preventing communication with the access point.	Check the access point settings when using the infrastructure mode. Depending on the access point, client access may be filtered by MAC address. Also, check that there are no transmission problems between the access point and wired clients, and between the access point and wireless clients.
Printing does not start.	The wireless LAN interface is not working.	Make sure the orange LED is lit, and the green LED is lit or flashing during transmission.
Printing does not start.	The Login User Name, Login Password, or Driver Encryption Key is incorrect.	Check the Login User Name, Login Password, and Driver Encryption Key.
Printing does not start.	Advanced encryption has been set using the Extended Security function.	Check the settings of the Extended Security function. For details about Extended Security function settings, see "Specifying the Extended Security Functions", Security Guide.
[List / Test Print] is disabled.	A mechanical error might have occurred.	Contact your service representative.

Problem	Cause	Solution
Printing does not start when using the extended wireless LAN in Ad-hoc Mode.	The correct Communication Mode is not set.	<ul style="list-style-type: none"> • Turn the main power switch off and then back on again. For details about how to turn on/off the main power switch, see page 26 "Turning On/Off the Power". • Change [Communication Mode] in [System Settings] to [802.11 Ad-hoc Mode], and then select [Off] for [Security Method]. For details about Communication Mode, see: <ul style="list-style-type: none"> • "Host Interface (SP C340DN)", Operating Instructions. • "Interface Settings (SP C342DN)", Operating Instructions.

If printing does not start, contact your service representative.

When the Data In Indicator Does Not Light Up or Flash

When the Data In indicator does not light up or flash after a print job starts, data is not being sent to the printer.

When the printer is connected to the computer using the interface cable

Check that the print port setting is correct. When connecting the printer to the computer using a parallel interface, connect using LPT1 or LPT2.

1. Open the printer properties dialog box, and then click the [Ports] tab.

For details about displaying the printer properties dialog box, see "Displaying the Printer Driver Properties with Windows", Operating Instructions.

2. In the [Print to the following port(s)] list, check that the correct port is selected.

Network connection

For details about the network connection, contact your administrator.

Other Printing Problems

This section describes likely causes of and possible solutions for problems that can occur when a print job is performed from a computer.

When You Cannot Print Properly

Problem	Cause	Solution
The printed image is smudged.	Settings for thick paper have not been configured when printing on thick paper in the bypass tray.	<p>PCL 5c</p> <p>On the printer driver's [Paper] tab, select [Bypass Tray] in the "Input Tray:" list. Then in the "Type:" list, select a proper paper type.</p> <p>PCL 6/PostScript 3</p> <p>On the printer driver's [Detailed Settings] tab, click [Paper] in "Menu:", and then select [Bypass Tray] in the "Input Tray:" list. Then in the "Paper Type:" list, select a proper paper type.</p>
Printed images contain blots or are patchy.	The paper is damp.	Use paper that has been stored in the recommended temperature and humidity conditions. For details about the proper way to store paper, see page 40 "Paper Precautions".
Printed images contain blots or are patchy.	The printer is not on a level surface.	The printer must be placed on a stable and level surface. Check the printer environment and select an appropriate location. For details about the printer's environment, see "Install Location", Operating Instructions.

Problem	Cause	Solution
Printed images contain blots or are patchy.	The paper is creased, curled, or has blemishes.	Smooth out the wrinkles or replace the paper. For details about paper, see page 40 "Paper Precautions".
The printed image is faded over the entire page.	The paper is damp.	Use paper that has been stored in the recommended temperature and humidity conditions. For details about the proper way to store paper, see page 40 "Paper Precautions".
The printed image is faded over the entire page.	The paper is unsuitable. Printing on coarse or treated paper might result in faint print image.	Use recommended paper. For details about recommended paper, see page 36 "Paper Size Specifications" and page 38 "Paper Type Specifications".
The printed image is faded over the entire page.	If [On] is selected in the "Economy Color" list in the printer driver settings, the entire page will be faded when printed.	PCL 6/PostScript 3 On the printer driver's [Detailed Settings] tab, click [Print Quality:Standard] in "Menu:", and then select [Off] in the "Economy Color".
Images smudge when rubbed. (Toner is not fixed.)	The specified paper type and the paper that is actually loaded might be different. For example, thick paper might be loaded but not specified as the paper type.	PCL 5c On the printer driver's [Paper] tab, select a proper paper type in the [Type:] box. PCL 6/PostScript 3 On the printer driver's [Detailed Settings] tab, click [Paper] in "Menu:", and then select a proper paper type in the "Paper Type:" list.

Problem	Cause	Solution
The printed image is different from the image on the computer's display.	Printing will be performed by the printer's graphic processing function.	PCL 6 On the printer driver's [Detailed Settings] tab, click [Print Quality:Advanced] in "Menu:", and then select [Raster] in the "Vector/Raster:" list.
The image is too dark or too light.	The paper type settings are not configured correctly.	Check that the paper loaded on the paper tray or bypass tray matches the paper type set on the display panel. For details about paper type settings, see page 57 "Paper Settings".
The image is too dark or too light.	The paper is loaded reverse side up. Printing on non-print surfaces reduces print quality and can damage the printer's internal components.	Before printing on special paper, check its surface carefully. For details about special paper, see page 40 "Paper Precautions".
Image is dirty.	Use of non-recommended toner can result in a loss of print quality and other problems.	Use genuine manufacturer toner. Contact your service representative.

Problem	Cause	Solution
Horizontal lines appear when an image filled in black is printed.	A black-and-white image is occasionally recognized as a color image and printed as a streak when a large number of pages that contain both black-and-white and color images are printed continuously.	<ul style="list-style-type: none"> • Set [B&W Page Detect] or [Black & White Page Detect] to [Per Page]. For details, see one of the followings depending on the model being used: <ul style="list-style-type: none"> • "System (SP C340DN)", Operating Instructions. • "Maintenance: Printing (SP C342DN)", Operating Instructions. • Change [Gray Reproduction] in the [Print Quality:Standard] menu of the printer driver to [CMY + K].
Horizontal streaks appear on the printed page.	Horizontal streaks may sometimes appear on the printed pages when a large number of pages are continuously printed in a high-temperature or humid environment.	Perform the automatic gradation correction. For details, see "Correcting the Color Gradation", Operating Instructions.
The lower half of the page appears faded when a filled-in image is printed.	When the "Toner is almost empty." or "Toner Cartridge is almost empty. Replace Toner Cartridge." message is displayed on the display panel, the toner is running low and the printed page may appear faded.	Replace the print cartridge.
Printed graphics do not match graphics on the screen.	If the printer driver is configured to use the graphics command, the graphics command from the printer is used to print.	If you want to print accurately, set the printer driver to print without using the graphics command. For details about settings for printer driver, see the printer driver Help.

Problem	Cause	Solution
Print result differs from the display.	A non-Windows operating system is being used.	Check that the application supports the printer driver.
Print result differs from the display.	The printer is not selected for printing.	Use the printer driver of the printer and check that the printer is the specified printer. For details about how to open the printer driver settings screen, see "Displaying the Printing Preferences dialog box from the [Start] menu", Operating Instructions.
Print result differs from the display.	Data transmission failed or was canceled during printing.	Check whether there is failed or canceled data remaining. For details about how to identify the cause of the error, see "Checking Error Logs", Operating Instructions.
Characters differ from the display.	The loaded paper is unsuitable.	Printing on recommended paper produces better resolution. For details about recommended paper, see page 36 "Paper Size Specifications" and page 38 "Paper Type Specifications".
Image position differs from the display.	The page layout settings are not configured correctly.	Check the page layout settings configured using the application. For details about page layout settings, see the application's Help.

Problem	Cause	Solution
Image position differs from the display.	The page layout settings are not configured correctly.	<p>PCL 5c</p> <p>On the printer driver's [Paper] tab, select [Print On] box, and then select the desired size.</p> <p>PCL 6 / PostScript 3</p> <p>On the printer driver's [Detailed Settings] tab, click [Basic] in "Menu:", and then select the desired size in the "Print On:" list.</p>
Lines of garbled or unwanted alphanumeric characters appear.	An incorrect printer language might have been selected.	Select the correct printer driver, and then print the file again.
Images are cut off, or excess is printed.	You may be using paper smaller than the size selected in the application.	Use the same size paper as that selected in the application. If you cannot load paper of the correct size, use the reduction function to reduce the image, and then print. For details about the reduction function, see the printer driver Help.
Photo images are grainy.	Some applications print at a lower resolution.	Use the application's or printer driver's settings to specify a higher resolution. For details about printer driver's settings, see the printer driver Help.
A solid line is printed as a dashed line or appears blurred.	Dither patterns do not match.	<p>PostScript 3</p> <p>Change the dithering settings on the printer driver. For details about the dithering settings, see the printer driver Help.</p>

Problem	Cause	Solution
Fine lines are fuzzy with inconsistent thickness or color, or do not appear.	Super fine lines have been specified in the application, or a color that is too light has been specified for the lines.	<p>PostScript 3</p> <p>Change the dithering settings on the printer driver. For details about the dithering settings, see the printer driver Help.</p> <p>If the problem continues after you change the dithering settings, use the settings of the application in which the image was created to change the color and thickness of the lines.</p>
Images appear only partially colored.	The paper is damp.	Use paper that has been stored in the recommended temperature and humidity conditions. For details about the proper way to store paper, see page 40 "Paper Precautions".

Paper Misfeeds Occur Frequently

Problem	Cause	Solution
Paper is not fed from the selected tray.	When you are using Windows, printer driver settings override those settings using the display panel.	<p>PCL 5c</p> <p>On the printer driver's [Paper] tab, select the desired input tray in the "Input Tray:" list.</p> <p>PCL 6/PostScript 3</p> <p>On the printer driver's [Detailed Settings] tab, click [Paper] in "Menu:", and then select the desired input tray in the "Input Tray:" list.</p>

Problem	Cause	Solution
Images are printed at a slant.	The tray's side fences might not be locked.	Check that the side fences are locked. For details about how to set the side fences, see page 43 "Loading Paper into Paper Trays" or page 49 "Loading Paper into the Bypass Tray".
Images are printed at a slant.	The paper is feeding in at a slant.	Load the paper correctly. For details about loading paper, see page 43 "Loading Paper into Paper Trays" or page 49 "Loading Paper into the Bypass Tray".
Misfeeds occur frequently.	The number of sheets loaded exceeds the capacity of the printer.	Load paper only as high as the upper limit markings on the side fences of the paper tray, or the markings on the paper guides of the bypass tray.
Misfeeds occur frequently.	The paper tray's side fences are set too tightly.	Push the side fences lightly, and then reset them.
Misfeeds occur frequently.	The paper is damp.	Use paper that has been stored in the recommended temperature and humidity conditions. For details about the proper way to store paper, see page 40 "Paper Precautions".
Misfeeds occur frequently.	The paper is too thick or too thin.	Use recommended paper. For details about recommended paper, see page 36 "Paper Size Specifications" and page 38 "Paper Type Specifications".

Problem	Cause	Solution
Misfeeds occur frequently.	The paper is wrinkled or has been folded/creased.	<ul style="list-style-type: none"> Use recommended paper. For details about recommended paper, see page 36 "Paper Size Specifications" and page 38 "Paper Type Specifications". Use paper that has been stored in the recommended temperature and humidity conditions. For details about the proper way to store paper, see page 40 "Paper Precautions".
Misfeeds occur frequently.	Paper edges are burred when cut in the manufacturing process.	<ul style="list-style-type: none"> Remove the burrs, for example, with a ruler. Load paper upside down. Use clean cut paper with no burrs.
Misfeeds occur frequently.	Printed paper is being used.	Do not load sheets that have already been copied or printed by another printer.
Misfeeds occur frequently.	Sheets are sticking together.	Fan the sheets thoroughly before loading them. Alternatively, feed the sheets into the printer one at a time.
Sheets are feeding in together, resulting in jams.	Sheets are sticking together.	Fan the sheets thoroughly before loading them. Alternatively, feed the sheets into the printer one at a time.
Printed paper becomes creased.	The paper is damp.	Use paper that has been stored in the recommended temperature and humidity conditions. For details about the proper way to store paper, see page 40 "Paper Precautions".

Problem	Cause	Solution
Printed paper becomes creased.	The paper is too thin.	Use recommended paper. For details about recommended paper, see page 36 "Paper Size Specifications" and page 38 "Paper Type Specifications".
Edges of sheets are creased.	The paper is damp.	Use paper that has been stored in the recommended temperature and humidity conditions. For details about the proper way to store paper, see page 40 "Paper Precautions".
Edges of sheets are creased.	You are using non-recommended paper.	Use recommended paper. For details about recommended paper, see page 36 "Paper Size Specifications" and page 38 "Paper Type Specifications".
Duplex printing is malfunctioning.	You have selected a paper tray that is not set for duplex print.	Change the setting to enable duplex printing for the paper tray.
Duplex printing is malfunctioning.	You have selected a paper type that cannot be used for duplex printing.	In [Tray Paper Settings], select a paper type that can be used for duplex printing. For details about the paper types that can be used, see "Printing on Both Sides of a Page", Operating Instructions.
The image on the back side of duplex printing has mottled blank patches or is smudged.	Missing patches and smudges are caused by moisture leaking from the paper.	<ul style="list-style-type: none"> Do not install the printer in areas that are susceptible to low temperature. Use paper that has been stored in the recommended temperature and humidity conditions. For details about the proper way to store paper, see page 40 "Paper Precautions".

Additional Troubleshooting

Problem	Causes	Solutions
<p>The output sheet falls from the output tray.</p> <p>Blocking occurs (the output sheets on the output tray stick together).</p>	<p>Depending on the size, type, or printing conditions of the prints, the output sheets may become badly curled.</p>	<ul style="list-style-type: none"> • Pull out the stop fence of the output tray before printing. • Turn over the stack of paper in the tray. • Remove all output sheets.
<p>It takes a long time to complete a print job.</p>	<p>Photographs and other data intensive pages take a long time for the printer to process, so simply wait when printing such data.</p>	<p>If the Data In indicator is flashing, data has been received by the printer. Wait for a moment.</p> <p>Changing the following settings with the printer driver may help speed up printing:</p> <ul style="list-style-type: none"> • Select [Speed] in "Print Priority" list. • Select a lower resolution. <p>For details about how to change the settings, see the printer driver Help.</p>
<p>Images are printed in the wrong orientation.</p>	<p>The feed orientation you selected and the feed orientation selected in the printer driver's option setup might not be the same.</p>	<p>Set the printer's feed orientation and the printer driver's feed orientation accordingly. For details about settings for printer driver, see the printer driver Help.</p>
<p>Optional components connected to the printer are not recognized.</p>	<p>Bidirectional communication is not working.</p>	<p>Set up optional devices on the properties of the printer. For details about how to set up optional devices, see the printer driver Help.</p>

Problem	Causes	Solutions
<p>Combined printing, booklet printing, or Auto Reduce/Enlarge printing does not come out as expected.</p>	<p>The application or printer driver settings are not configured correctly.</p>	<p>Make sure the application's paper size and orientation settings match those of the printer driver. If a different paper size and orientation are set, select the same size and orientation.</p>
<p>Some types of data, such as graphics data or data from certain applications, do not print.</p>	<p>The printer driver settings are not configured correctly.</p>	<p>PCL 5c</p> <p>On the printer driver's [Print Quality] tab, select [600 dpi] in the "Resolution" area.</p> <p>PCL 6</p> <ul style="list-style-type: none"> • On the printer driver's [Detailed Settings] tab, click [Print Quality:Standard] in "Menu:", and then select [Quality] in the "Print Priority:" list. • On the printer driver's [Detailed Settings] tab, click [Print Quality:Advanced] in "Menu:", and then select [Raster] in the "Vector/Raster:" list. <p>PostScript 3</p> <p>On the printer driver's [Detailed Settings] tab, click [Print Quality:Standard] in "Menu:", and then select [Photographic] in the "Dithering:" list.</p> <p>For details about the printer driver settings, see the printer driver Help.</p>

Problem	Causes	Solutions
<p>Some characters are not printed or appear strange.</p>	<p>The printer driver settings are not configured correctly.</p>	<p>PCL 5c</p> <p>On the printer driver's [Print Quality:Standard] tab, select [600 dpi] in the "Resolution" area.</p> <p>PCL 6</p> <ul style="list-style-type: none"> • On the printer driver's [Detailed Settings] tab, click [Print Quality:Standard] in "Menu:", and then select [Quality] in the "Print Priority:" list. • On the printer driver's [Detailed Settings] tab, click [Print Quality:Advanced] in "Menu:", and then select [Raster] in the "Vector/Raster:" list. <p>PostScript 3</p> <p>On the printer driver's [Detailed Settings] tab, click [Print Quality:Standard] in "Menu:", and then select [Text] in the "Dithering:" list.</p> <p>For details about the printer driver settings, see the printer driver Help.</p>

Problem	Causes	Solutions
Print speed or application relinquishing speed is slow.	The printer driver settings are not configured correctly.	<p>PCL 6</p> <p>On the printer driver's [Detailed Settings] tab, click [Print Quality:Standard] in "Menu:", and then select [Speed] in the "Print Priority:" list.</p> <p>For details about the printer driver settings, see the printer driver Help.</p> <p>Quit any other applications.</p>
Print ends mid-job.	An error might have occurred.	Check the printer's display panel to see if an error has occurred.
A print instruction was issued from the computer, but printing did not start.	User Authentication may have been set.	For details about User Authentication, see "Configuring User Authentication", Security Guide.
Color originals are printed in black and white.	No color print settings are configured on the printer driver.	Change the "Color/ Black and White:" setting on the printer driver. For details about how to change the "Color/ Black and White:" setting, see the printer driver Help.
PDF files do not print out/ cannot perform PDF direct print.	PDF files are password-protected.	To print password-protected PDF files, enter the password in [PDF Menu].
PDF files do not print out/ cannot perform PDF direct print.	PDF files cannot be printed if they are print-disabled in PDF file security setting.	Change the PDF file security setting.
PDF direct print produces strange or malformed characters.	Fonts were not embedded.	Embed fonts in the PDF file you want to print, and then print.
"Resetting job..." appears and printing is suspended.	Memory is insufficient.	In [System], select [Memory Usage] to [Font Priority].

Problem	Causes	Solutions
Printing did not start even though the specified print time has already passed.	[Jobs Not Printed As Machn. Was Off] was set to [Do not Print] in [Printer Features], but at the specified printing time, the main power switch was turned off or the printer was in Low Power Mode.	Set [Jobs Not Printed As Machn. Was Off] to [Prt When Mach On] in [Printer Features]. This function is available for SP C342DN only.
Printing did not start even though the specified print time has already passed.	The time set on the printer or computer is incorrect.	Set the correct time on the printer or computer.
Printing via wireless LAN is slow.	The number of jobs exceeds the capacity of the printer.	Reduce the number of jobs.
Printing via wireless LAN is slow.	<ul style="list-style-type: none"> • A communication error might have occurred. • Interference from other wireless LAN devices can reduce the communication speed • If the printer is using a wireless LAN, radio waves may be interfering with the wireless communication. This may occur if there is a microwave oven, cordless telephone, industrial printer, scientific instrument, or medical instrument using the same frequency range near the device. 	<ul style="list-style-type: none"> • Move the printer farther away from the wireless LAN device. • If there are active wireless LAN devices nearby, move the printer or disable those devices. • Turn off other printers or instruments that use the same frequency range, and then try printing again. If printing is successful, move the devices to a location where they do not interfere with the printer.

The Printed Image is Different from the Image on the Computer

Problem	Solutions
The printed image is different from the image on the computer's display.	When you use some functions, such as enlargement or reduction, the layout of the image might be different from that displayed on the computer display.
Images are cut off, or excess pages are printed.	<p>If you are using paper smaller than the paper size selected in the application, use the same size paper with that selected in the application. If you cannot load paper of the correct size, use the reduction function to reduce the image, and then print.</p> <p>For details, see the printer driver's Help.</p>
PDF Direct Print is not executed (PDF file is not printed).	<p>You must install an optional hard disk or set the value of [RAM Disk] in the System Menu to 2 MB or higher.</p> <p>For details about [RAM Disk], see:</p> <ul style="list-style-type: none"> • "System (SP C340DN)", Operating Instructions. • "System (SP C342DN)", Operating Instructions. <p>When printing a PDF using a password, set the password of the PDF file using the [Change PDF Password] menu in [PDF Menu] or Web Image Monitor. For details about [Change PDF Password], see:</p> <ul style="list-style-type: none"> • see "PDF Menu (SP C340DN)", Operating Instructions. • see "PDF Menu (SP C342DN)", Operating Instructions. <p>For details about Web Image Monitor, see Web Image Monitor Help.</p> <ul style="list-style-type: none"> • PDF files not allowed to be printed by the PDF file security setting cannot be printed. • Highly compressed PDFs cannot be printed using PDF Direct Print. Open the relevant application and print the PDF file using the printer driver. Set the file format to standard PDF.
As a result of printing using PDF Direct Printing, characters are missing or misshapen.	Before printing, embed the font in the PDF file to be printed.

Problem	Solutions
The paper size appears on the control panel and printing is not performed with PDF Direct Print.	<p>When PDF Direct Print is used, printout requires paper set within the PDF file. When a message indicating a paper size appears, either place the indicated size in the paper tray or perform Form Feed.</p> <p>Also, if [Sub Paper Size] in the [System] menu is set to [Auto], printing is performed assuming Letter size and A4 size to be the same size. For example, when a PDF file set to A4 size paper is printed using PDF Direct Print and Letter size paper is loaded in the paper tray, or vice versa, the file will be printed out.</p>
The color of the printout is different from the color on the computer's display.	<ul style="list-style-type: none"> • The colors created using color toner are different from the ones displayed on the display. • If you select [On] for [Economy Color:] on the [Print Quality] menu in the printer driver's dialog box, the color gradation may appear differently. For details, see the printer driver's Help. • Turn the printer off, and then turn it on again. If the colors are different from what you expect, perform [Color Registration]. For details, see "Adjusting the Color Registration", Operating Instructions.
The color of the printout is different from the color specified.	<p>If a specific color is missing turn the printer off, wait a few moments, and then turn it on again. If this does not resolve the problem, contact your sales or service representative.</p>
The color changes significantly when adjusted with the printer driver.	<p>Do not make extreme settings for the color balance on the [Print Quality] menu under the [Detailed Settings] tab in the printer driver's dialog box.</p> <p>Note that the sample image displayed in the printer driver is used only to show what processing will be performed, so it may not match the print results.</p> <p>For details, see the printer driver's Help.</p>
Color documents are printed in black and white.	<ul style="list-style-type: none"> • Color printing is not enabled for the printer. For details, see the printer driver's Help. • Some applications print color files in black and white.
Solid areas, lines, or text are shiny or glossy when created as a mixture of cyan, magenta, yellow.	<ul style="list-style-type: none"> • Select [K (Black)] for [Gray Reproduction:] in the printer driver's dialog box. For details, see the printer driver's Help.

Problem	Solutions
Black gradation is not natural.	<ul style="list-style-type: none"> • Select [CMY + K] for [Gray Reproduction:] in the printer driver's dialog box. <p>For details, see the printer driver's Help.</p>
A color is missing or partially blurred.	<ul style="list-style-type: none"> • Paper is damp. Use paper that has been stored properly. For details, see page 40 "Paper Precautions". • A print cartridge is almost empty. When the "Toner is almost empty." message appears on the display panel. If the toner indicator on the initial screen seems empty, replace the print cartridge of the displayed color. For details, see "Replacing the Print Cartridge", Operating Instructions. • Condensation may have collected. If there were sudden changes in temperature or humidity, restart the printer when it is acclimatized.

When Printer Is Not Functioning Properly

Problem	Solutions
Paper is not fed from the selected tray.	<p>When you are using a Windows operating system, the printer driver settings override those set using the control panel. Set the input tray you want using the printer driver.</p> <p>For details, see the printer driver's Help.</p>
Prints do not stack properly.	<ul style="list-style-type: none"> • Paper is damp. Use paper that has been stored properly. See page 40 "Paper Precautions". • If printed sheets come out curled, use the standard tray extension. See page 10 "Guide to Components".
It takes too long to turn on the printer.	<p>If the printer is turned off while accessing the hard disk (for example: during file deletion), the printer will require more time to power-up the next time it is turned on. To avoid this time delay, do not turn the printer off while it is in operation.</p>

Problem	Solutions
It takes too long to resume printing.	<ul style="list-style-type: none"> • The data is so large or complex that it takes time to process it. If Data In indicator is flashing, the data is being processed. Wait until it resumes. • The printer was in the Energy Saver mode or the Sleep mode. To recover from these modes, the printer must warm up, and this takes time until printing starts. For details, see page 27 "Saving Energy".
It takes too long to complete the print job.	<ul style="list-style-type: none"> • Photographs and other data-intensive pages take a long time for the printer to process, so wait when printing such data. Changing the settings with printer driver may help to speed up printing. For details, see the printer driver's Help. • The data is so large or complex that it takes time for the printer to process it. If Data In indicator is flashing, the data is being processed. Wait until it resumes. • If "Waiting for print data..." appears on the display, the printer is now warming up. Wait for a while. The printer is adjusting the color registration. Wait for a while.
Attached options are not detected in the printer properties.	The computer and printer are not in bidirectional communication. You must configure attached options in the printer properties. For details, see the printer driver's Help.
When printing combined prints or bound prints.	Check that the paper size and direction set in the printer driver are the same as those set in the application. If the settings are not the same, change the settings of the printer driver.
An empty tray is selected by Auto Tray Select, and the document is not printed due to out of paper error.	If a paper tray is opened and closed while the printer is in Energy Saver mode, the printer will initialize the tray upon recovery, but the tray will not be selectable by Auto Tray Select. To print from a paper tray that you opened and closed while the printer was in Energy Saver mode, you must manually specify the tray as the source paper tray before printing. When the printer recovers from Energy Saver mode and completes initialization, it will then print the document from the tray you have specified.

When PictBridge Printing Does Not Work

Problem	Causes	Solutions
PictBridge is not available.	There is a problem with the USB connection or the PictBridge settings.	Use the following procedure to check the connection and settings: <ol style="list-style-type: none"> 1. Disconnect, and then reconnect the USB cable. 2. Check that the PictBridge settings are enabled. 3. Disconnect the USB cable, and then turn off the printer. Turn the printer back on. When the printer has fully booted up, reconnect the USB cable.
When two or more digital cameras are connected, the second and subsequent cameras are not recognized.	You have connected multiple digital cameras.	Connect only one digital camera. Do not connect multiple cameras.
Printing is disabled.	The number of originals exceeds the maximum number of pages that can be printed at a time.	The maximum specifiable print quantity at a time is 999. Respecify the quantity to 999 or less, and then retry printing.
Printing is disabled.	There is no paper of the specified size remaining.	There is no paper of the specified size remaining. If you have to use paper that is not of the specified size, perform Form Feed. To cancel printing, perform Job Cancel.
Printing is disabled.	The paper size setting for this tray cannot be printed on the printer.	Select the paper size setting that can be printed on the printer.

Removing Jammed Paper

An error message appears if a paper misfeed occurs. The error message indicates where the misfeed occurs.

Check the location and remove the paper.

⚠ CAUTION

- The inside of the machine could be very hot. Do not touch the parts with a label indicating the "hot surface." Otherwise, an injury might occur.
- Some of this machine's internal components get very hot. For this reason, take care when removing misfed paper. Not doing so could result in burns.
- When removing jammed paper, make sure not to trap or injure your fingers.

★ Important

- To prevent misfeeds, do not leave any torn scraps of paper inside the printer.
- Contact your service representative if misfeeds occur frequently.
- If the error message remains displayed even after you remove misfed paper, open and close the front cover.

Paper Misfeed Message (A)

1. Pull the front cover open lever, and then open the front cover with both hands carefully.

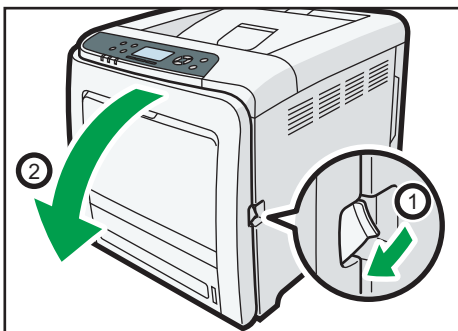

DPP058

2. Carefully pull the jammed paper upward and out.

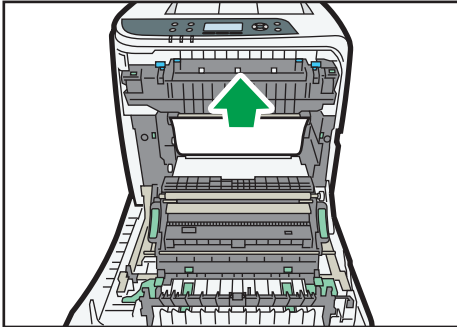

DPP059

If paper has jammed inside the paper transfer unit, holding both sides of the paper, pull the paper carefully forward and out.

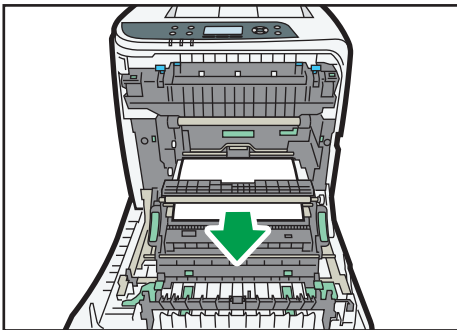

DPP060

3. Close the front cover with both hands carefully.

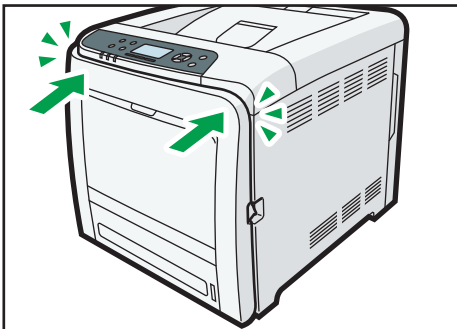

DPP061

Note

- Do not pull out the paper tray (Tray 1).
- If paper is jammed in Tray 2, but it is difficult to locate, pull out Tray 2 to remove it. After removing the paper, carefully push Tray 2 all the way back inside the printer.
- When closing the front cover, push the upper side of the cover firmly. After closing the cover, check that the error is cleared.

Misfeed Bypass Tray

1. Remove paper loaded in the bypass tray, and then close the bypass tray with both hands.



DPP062

2. Pull Front Cover Open Lever, and then open the front cover with both hands carefully.

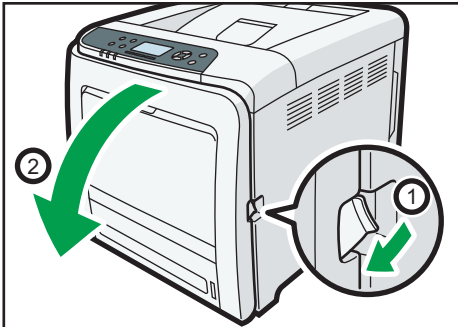

DPP058

3. Pull out the jammed paper carefully.

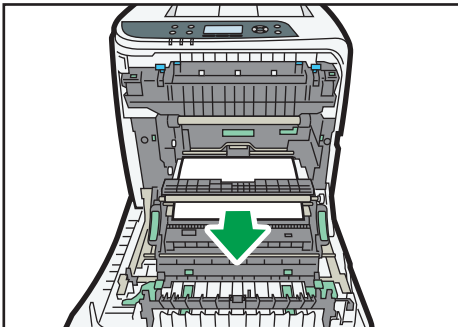

DPP060

4. Close the front cover with both hands carefully.

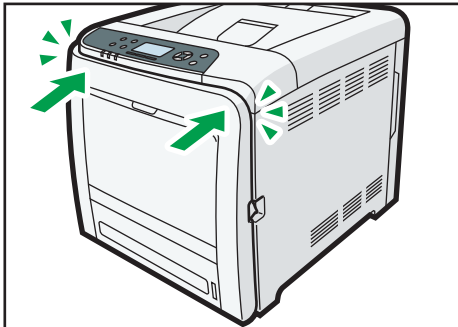

DPP061

Note

- Be sure the Tray 1 is inserted before you open the front cover.
- When closing the front cover, push the upper side of the cover firmly. After closing the cover, check that the error is cleared.

Paper Misfeed Message (B)

Important

- The inside of this printer becomes very hot. Before removing paper around the fusing unit, wait until the temperature of the covers inside the fusing unit and paper transfer unit cools down.

1. Pull the front cover open lever, and then open the front cover with both hands carefully.

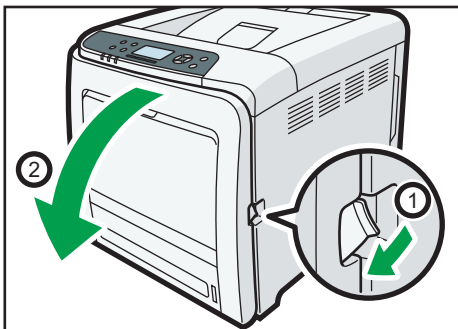

DPP058

2. Lower the blue fusing unit levers, and pull out the jammed paper carefully.

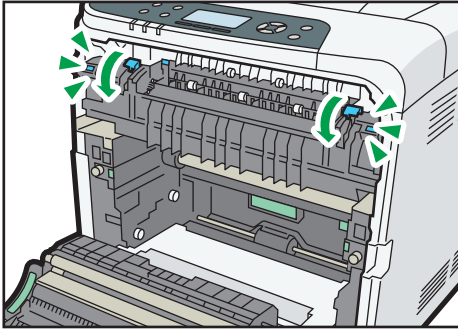

DPP063

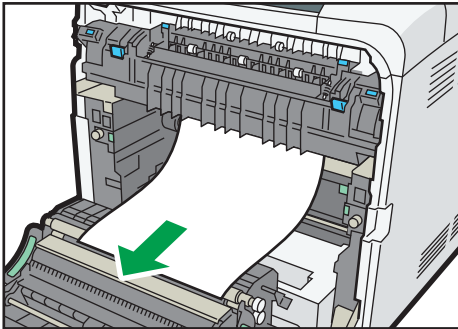

DPP064

Pull the paper downward to remove it. Do not pull it upward.

If the jammed paper is visible in the output tray, lower the blue fusing unit levers, and then pull the jammed paper out of the tray.

If you cannot find the jammed paper, open the guide by lowering the guide's blue levers. Check inside the guide for the jammed paper.

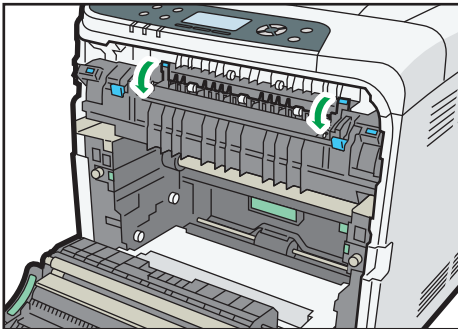

DPP065

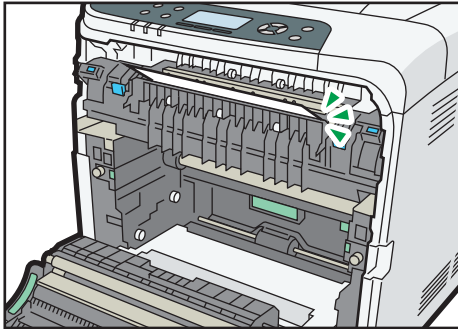

DPP066

Be sure to fully close the guide after you have checked inside it for jammed paper.

Attempting to close the front cover when the guide is still open will damage one or both of these components.

3. Close the front cover with both hands carefully.

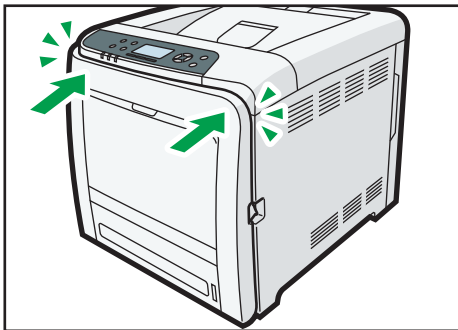

DPP061

↓ Note

- When closing the front cover, push the upper side of the cover firmly. After closing the cover, check that the error has cleared.

Paper Misfeed Message (Y)

The solution for Paper Misfeed Message (Y) is the same as that for Paper Misfeed Message (A). For details, see page 114 "Paper Misfeed Message (A)".

↓ Note

- If the paper is jammed and difficult to see in the paper feed unit, detach the paper feed unit, and then remove the jammed paper.
- After removing the jammed paper, press down the paper in the paper feed unit until it clicks at the bottom, and then reattach the paper feed unit carefully.

Paper Misfeed Message (Z)

1. Pull the front cover open lever, and then open the front cover with both hands carefully.

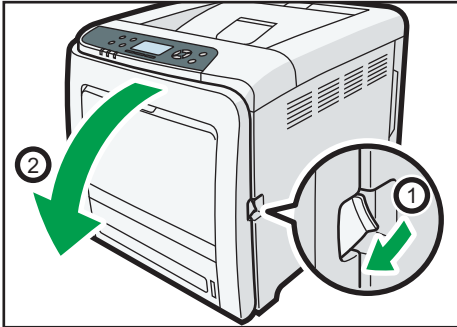

2. Carefully remove jammed paper under the paper transfer unit.

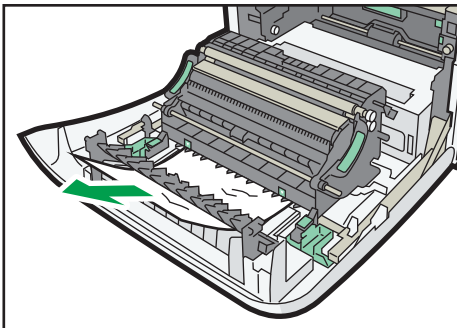

3. Close the front cover with both hands carefully.

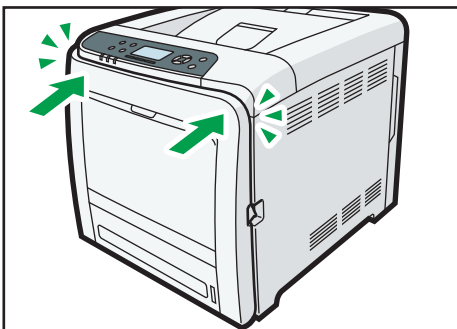

Note

- When closing the front cover, push the upper side of the cover firmly. After closing the cover, check that the error has cleared.

Trademarks

Adobe, Acrobat, PostScript, and PostScript 3 are either registered trademarks or trademarks of Adobe Systems Incorporated in the United States and/or other countries.

Bonjour, Macintosh, Mac OS, OS X, and Safari are trademarks of Apple Inc., registered in the United States and other countries.

Citrix, Citrix Presentation Server and Citrix XenApp are either registered trademarks or trademarks of Citrix Systems, Inc.

Firefox® is a registered trademark of the Mozilla Foundation.

IPS is a trademark or registered trademark of Zoran Corporation and/or its subsidiaries in the United States or other countries.

Java is a registered trademark of Oracle and/or its affiliates.

JAWS® is a registered trademark of Freedom Scientific, Inc., St. Petersburg, Florida and/or other countries.

Microsoft, Windows, Windows Server, Windows Vista, and Internet Explorer are either registered trademarks or trademarks of Microsoft Corporation in the United States and/or other countries.

Monotype is a registered trademark of Monotype Imaging Inc.

IPX, IPX/SPX, NCP, and NDS are either registered trademarks or trademarks of Novell, Inc.

OpenLDAP is a registered trademark of the OpenLDAP Foundation.

PCL® is a registered trademark of Hewlett-Packard Company.

PictBridge is a trademark.

UNIX is a registered trademark of the Open Group.

UPnP™ is a trademark of the UPnP™ Implementers Corporation.

The proper name of Internet Explorer 6 is Microsoft® Internet Explorer® 6.

The proper name of Internet Explorer 8 is Windows® Internet Explorer® 8.

The proper names of the Windows operating systems are as follows:

- The product names of Windows Vista are as follows:

Microsoft® Windows Vista® Ultimate

Microsoft® Windows Vista® Business

Microsoft® Windows Vista® Home Premium

Microsoft® Windows Vista® Home Basic

Microsoft® Windows Vista® Enterprise

- The product names of Windows 7 are as follows:

Microsoft® Windows® 7 Home Premium

Microsoft® Windows® 7 Professional

Microsoft® Windows® 7 Ultimate

Microsoft® Windows® 7 Enterprise

- The product names of Windows 8 are as follows:

Microsoft® Windows® 8

Microsoft® Windows® 8 Pro

Microsoft® Windows® 8 Enterprise

- The product names of Windows 8.1 are as follows:

Microsoft® Windows® 8.1

Microsoft® Windows® 8.1 Pro

Microsoft® Windows® 8.1 Enterprise

- The product names of Windows 10 are as follows:

Microsoft® Windows® 10 Home

Microsoft® Windows® 10 Pro

Microsoft® Windows® 10 Enterprise

Microsoft® Windows® 10 Education

- The product names of Windows Server 2003 are as follows:

Microsoft® Windows Server® 2003 Standard Edition

Microsoft® Windows Server® 2003 Enterprise Edition

- The product names of Windows Server 2003 R2 are as follows:

Microsoft® Windows Server® 2003 R2 Standard Edition

Microsoft® Windows Server® 2003 R2 Enterprise Edition

- The product names of Windows Server 2008 are as follows:

Microsoft® Windows Server® 2008 Standard

Microsoft® Windows Server® 2008 Enterprise

- The product names of Windows Server 2008 R2 are as follows:

Microsoft® Windows Server® 2008 R2 Standard

Microsoft® Windows Server® 2008 R2 Enterprise

- The product names of Windows Server 2012 are as follows:

Microsoft® Windows Server® 2012 Foundation

Microsoft® Windows Server® 2012 Essentials

Microsoft® Windows Server® 2012 Standard

- The product names of Windows Server 2012 R2 are as follows:

Microsoft® Windows Server® 2012 R2 Foundation

Microsoft® Windows Server® 2012 R2 Essentials

Microsoft® Windows Server® 2012 R2 Standard

Other product names used herein are for identification purposes only and might be trademarks of their respective companies. We disclaim any and all rights to those marks.

Microsoft product screen shots reprinted with permission from Microsoft Corporation.

MEMO

