



CLP35DN/CLP40DN
SP C430_{DN}/SP C431_{DN}
LPI35CN/LPI40CN
Aficio SP C430_{DN}/SP C431_{DN}

Safety Information

Consignes de sécurité

Información de seguridad

Informações de Segurança

English

Français

Español

Português

Information

Introduction

This manual contains detailed instructions and notes on the operation and use of this machine. For your safety and benefit, read this manual carefully before using the machine. Keep this manual in a handy place for quick reference.

Important

Contents of this manual are subject to change without prior notice. In no event will the company be liable for direct, indirect, special, incidental, or consequential damages as a result of handling or operating the machine.



Notes:

Some illustrations in this manual might be slightly different from the machine. Certain options might not be available in some countries. For details, please contact your local dealer. Depending on which country you are in, certain units may be optional. For details, please contact your local dealer.



Caution

For good print quality, the manufacturer recommends that you use genuine toner from the manufacturer. The manufacturer shall not be responsible for any damage or expense that might result from the use of parts other than genuine parts from the manufacturer with your office products.

Notes

The model names of the machines do not appear in the following pages. Check the type of your machine before reading this manual. (For details, see "Machine Types", Hardware Guide in the CD-ROM.)

- Type 1: CLP37DN/SP C430DN/LP137CN/Aficio SP C430DN
- Type 2: CLP42DN/SP C431DN/LP142CN/Aficio SP C431DN

Certain types might not be available in some countries. For details, please contact your local dealer.

Two kinds of size notation are employed in this manual. With this machine refer to the inch version.

Power Source

120 - 127 V, 50/60 Hz, 12 A or more

Please be sure to connect the power cable to a power source as above.

Laws and Regulations

Legal Prohibition

Do not copy or print any item for which reproduction is prohibited by law.

Copying or printing the following items is generally prohibited by local law:

bank notes, revenue stamps, bonds, stock certificates, bank drafts, checks, passports, driver's licenses.

The preceding list is meant as a guide only and is not inclusive. We assume no responsibility for its completeness or accuracy. If you have any questions concerning the legality of copying or printing certain items, consult with your legal advisor.

Laser Safety

CDRH Regulations

This equipment complies with requirements of 21 CFR subchapter J for class 1 laser products.

This equipment contains one AlGaInP laser diode, with 15 milliwatt, 657 - 663 nanometer wavelength.

This equipment does not emit hazardous light, since the beam is totally enclosed during all customer modes of operation and maintenance.

Caution:

Use of controls or adjustments or performance of procedures other than those specified in this manual might result in hazardous radiation exposure.

FCC Rules and IC Rules

Warning:

This device complies with part 15 of the FCC Rules and RSS-Gen of IC Rules.

Operation is subject to the following two conditions:

1. This device may not cause harmful interference, and
2. This device must accept any interference received, including interference that may cause undesired operation.

Changes or modifications not expressly approved by the party responsible for compliance could void the user's authority to operate the equipment.

This device must not be co-located or operated in conjunction with any other antenna or transmitter except for Wireless LAN module R-WL54CN (FCC ID: BBP-WLRWL541) which performed co-location testing.

Note to users in the United States of America

FCC Rules

❖ Declaration of Conformity

This device complies with Part 15 of the FCC Rules.

Operation is subject to the following two conditions:

- (1) This device may not cause harmful interference, and
- (2) this device must accept any interference received, including interference that may cause undesired operation.

Responsible party: Ricoh Americas Corporation.

Address: 5 Dedrick Place, West Caldwell, NJ 07006

Telephone number: 973-882-2000

Product Name: Laser Printer

Model Number: CLP37DN/SP C430DN/LP137CN/Aficio SP C430DN
CLP42DN/SP C431DN/LP142CN/Aficio SP C431DN

❖ Note

This equipment has been tested and found to comply with the limits for a Class B digital device, pursuant to Part 15 of the FCC Rules. These limits are designed to provide reasonable protection against harmful interference in a residential installation. This equipment generates, uses and can radiate radio frequency energy and, if not installed and used in accordance with the instructions, may cause harmful interference to radio communications. However, there is no guarantee that interference will not occur in a particular installation. If this equipment does cause harmful interference to radio or television reception, which can be determined by turning the equipment off and on, the user is encouraged to try to correct the interference by one or more of the following measures:

- Reorient or relocate the receiving antenna.
- Increase the separation between the equipment and receiver.
- Connect the equipment into an outlet on a circuit different from that to which the receiver is connected.
- Consult the dealer or an experienced radio /TV technician for help.

❖ Caution

Changes or modifications not expressly approved by the party responsible for compliance could void the user's authority to operate the equipment.

Notes on lamp(s) inside this machine

LAMP(S) INSIDE THIS PRODUCT CONTAIN MERCURY AND MUST BE RECYCLED OR DISPOSED OF ACCORDING TO LOCAL, STATE OR FEDERAL LAWS.

Notes to users in the state of California

Perchlorate Material - special handling may apply, See www.dtsc.ca.gov/hazardouswaste/perchlorate

Note to users in Canada

Note

This Class B digital apparatus complies with Canadian ICES- 003.

Remarque concernant les utilisateurs au Canada

Avertissement

Cet appareil numérique de la classe B est conforme à la norme NMB-003 du Canada.

Safety Information

When using this machine, the following safety precautions should always be followed.

Safety During Operation

In this manual, the following important symbols are used:

⚠ WARNING:

Indicates a potentially hazardous situation which, if instructions are not followed, could result in death or serious injury.

⚠ CAUTION:

Indicates a potentially hazardous situation which, if instructions are not followed, may result in minor or moderate injury or damage to property.

Safety Precautions to be Followed

This section explains safety precautions that should always be followed when using this machine.

Environments where the machine can be used

This section explains safety precautions about environments where the machine can be used.

⚠ WARNING:

- ***Do not use flammable sprays or solvents in the vicinity of this machine. Doing so could result in fire or electric shock.***
- ***Do not place vases, plant pots, cups, toiletries, medicines, small metal objects, or containers holding water or any other liquids, on or close to this machine. Fire or electric shock could result from spillage or if such objects or substances fall inside this machine.***

⚠ CAUTION:

- *Keep the machine away from humidity and dust. Otherwise a fire or an electric shock might occur.*
- *Do not place the machine on an unstable or tilted surface. If it topples over, an injury might occur.*
- *Do not place heavy objects on the machine. Doing so can cause the machine to topple over, possibly resulting in injury.*

• *Make sure the room where you are using the machine is well ventilated and spacious. Good ventilation is especially important when the machine is used heavily.*

• *Do not obstruct the machine's vents. Doing so risks fire caused by overheated internal components.*

• *When new, electrical devices containing volatile materials will normally release emissions into the air of their vicinity. For this reason, for the first few days after installation of a new device, strong ventilation inside the room where it is placed is necessary.*

• *Machine sound levels exceeding LWAd > 63 dB (A) are not suitable for desk work environments, so place the machine in another room.*

• *The tip-resistant caster table is required if the printer is to be used while placed on the floor with the optional paper feed unit installed. Not using the tip-resistant caster table risks injury to users and damage to the printer resulting from toppling. The tip-resistant caster table can only be installed by a service representative. Contact your service representative for details.*

Note

- To avoid possible build-up of ozone, make sure to locate this machine in a large well ventilated room that has an air turnover of more than 30 m³/hr/person.

Handling power cords and power plugs

This section explains safety precautions about handling power cords and power plugs.

WARNING:

• ***If the power cord is damaged and its inner wires are exposed or broken, contact your service representative for a replacement. Use of damaged power cords could result in fire or electric shock.***

• ***Do not use any power sources other than those that matches the specifications shown in this manual. Doing so could result in fire or electric shock.***

• ***Do not use any frequencies other than those that match the specifications shown. Doing so could result in fire or electric shock.***

• ***Do not use multi-socket adaptors. Doing so could result in fire or electric shock.***

Do not use extension cords. Doing so could result in fire or electric shock.

Do not use power cords that are damaged, broken, or modified. Also, do not use power cords that have been trapped under heavy objects, pulled hard, or bent severely. Doing so could result in fire or electric shock.

Touching the prongs of the power cable's plug with anything metallic constitutes a fire and electric shock hazard.

The supplied power cord is for use with this machine only. Do not use it with other appliances. Doing so could result in fire or electric shock.

It is dangerous to handle the power cord plug with wet hands. Doing so could result in electric shock.

 CAUTION:

Be sure to push the plug of the power cord fully into the wall outlet. Partially inserted plugs create an unstable connection that can result in unsafe buildup of heat.

If this machine is not going to be used for several days or longer at a time, disconnect its power cord from the wall outlet.

When disconnecting the power cord from the wall outlet, always pull the plug, not the cord. Pulling the cord can damage the power cord. Use of damaged power cords could result in fire or electric shock.

Be sure to disconnect the plug from the wall outlet and clean the prongs and the area around the prongs at least once a year. Allowing dust to build up on the plug constitutes a fire hazard.

When performing maintenance on the machine, always disconnect the power cord from the wall outlet.

Handling the main machine

This section explains safety precautions about handling the main machine.

 WARNING:

Be sure to locate the machine as close as possible to a wall outlet. This will allow easy disconnection of the power cord in the event of an emergency.

• If the machine emits smoke or odours, or if it behaves unusually, you must turn off its power immediately by pressing the power switch. After turning off the power, be sure to disconnect the power cord plug from the wall outlet. Then contact your service representative and report the problem. Do not use the machine. Doing so could result in fire or electric shock.

• If metal objects, or water or other fluids fall inside this machine, you must turn off its power immediately by pressing the power switch. After turning off the power, be sure to disconnect the power cord plug from the wall outlet. Then contact your sales or service representative and report the problem. Do not use the machine. Doing so could result in fire or electric shock.

• If the machine topples, or if a cover or other part gets broken, you must turn the power switch to off and disconnect the power cord plug from the wall outlet. Then contact your service representative and report the problem. Do not use the machine. Doing so could result in fire or electric shock.

• Do not touch this machine if a lightning strike occurs in the immediate vicinity. Doing so could result in electric shock.

• Keep the polythene materials (bags, etc.) supplied with this machine away from babies and small children at all times. Suffocation can result if polythene materials are brought into contact with the mouth or nose.

⚠ CAUTION:

• Unplug the power cord from the wall outlet before you move the machine. While moving the machine, take care that the power cord is not damaged under the machine. Failing to take these precautions could result in fire or electric shock.

• Before installing or removing options, always remove the power cords from the wall outlet and allow time for the main unit to fully cool. Failing to take these precautions could result in burns.

• For environmental reasons, do not dispose of the machine or expended supply waste at household waste collection points. Disposal can take place at an authorized dealer.

• When moving the machine, hold the inset grips at both sides, and then lift the printer slowly. Lifting it carelessly or dropping it may cause an injury.

⚙ Important

- Rating voltage of the connector for options: Max. DC 24 V.
- Voltage must not fluctuate more than 10%.

Handling the machine's interior

This section explains safety precautions about handling the machine's interior.

WARNING:

- ***Do not remove any covers or screws other than those explicitly mentioned in this manual. Inside this machine are high voltage components that are an electric shock hazard and laser components that could cause blindness. Contact your sales or service representative if any of the machine's internal components require maintenance, adjustment, or repair.***
- ***Do not attempt to disassemble or modify this machine. Doing so risks burns and electric shock. Note again that exposure to the laser components inside this machine risks blindness.***

CAUTION:

- *Some of this machine's internal components get very hot. For this reason, take care when removing misfed paper. Not doing so could result in burns.*
- *The fusing section of this machine might be very hot. Caution should be taken when removing misfed paper.*
- *The inside of the machine could be very hot. Do not touch the parts with a label indicating the "hot surface". Otherwise, an injury might occur.*
- *When loading paper, take care not to trap or injure your fingers.*
- *During operation, rollers for transporting the paper and originals revolve. A safety device has been installed so that the machine can be operated safely. But take care not to touch the machine during operation. Otherwise, an injury might occur.*
- *If the machine's interior is not cleaned regularly, dust will accumulate. Fire and breakdown can result from heavy accumulation of dust inside this machine. Contact your sales or service representative for details about and charges for cleaning the machine's interior.*
- *Do not pull out the paper tray forcefully. If you do, the tray might fall and cause an injury.*
- *Do not touch the inside of the controller board compartment. It may cause a machine malfunction or a burn.*
- *Risk of explosion if battery is replaced by an incorrect type. Dispose of used batteries according to the instructions.*

Handling the machine's supplies

This section explains safety precautions about handling the machine's supplies.

WARNING:

- ***Do not incinerate toner (new or used) or toner containers. Doing so risks burns. Toner will ignite on contact with naked flame.***
- ***Do not store toner (new or used) or toner containers anywhere near naked flames. Doing so risks fire and burns. Toner will ignite on contact with naked flame.***
- ***Keep the polythene materials (bags, gloves, etc.) supplied with this machine away from babies and small children at all times. Suffocation can result if polythene materials are brought into contact with the mouth or nose.***

CAUTION:

- *Do not crush or squeeze toner containers. Doing so can cause toner spillage, possibly resulting in dirtying of skin, clothing, and floor, and accidental ingestion.*
- *Keep toner (used or unused) and toner containers out of reach of children.*
- *If toner or used toner is inhaled, gargle with plenty of water and move into a fresh air environment. Consult a doctor if necessary.*
- *If toner or used toner gets into your eyes, flush immediately with large amounts of water. Consult a doctor if necessary.*
- *If toner or used toner is swallowed, dilute by drinking a large amount of water. Consult a doctor if necessary.*
- *When removing jammed paper or replacing toner, avoid getting toner (new or used) on your clothing. If toner comes into contact with your clothing, wash the stained area with cold water. Hot water will set the toner into the fabric and make removing the stain impossible.*
- *When removing jammed paper or replacing toner, avoid getting toner (new or used) on your skin. If toner comes into contact with your skin, wash the affected area thoroughly with soap and water.*
- *Do not use any other type of conductive paper. Doing so risks fire.*

Safety Labels of This Machine

This section explains the machine's safety information labels.

Positions of ⚠️ WARNING and ⚠️ CAUTION labels

This machine has labels for ⚠️ WARNING and ⚠️ CAUTION at the positions shown below. For safety, please follow the instructions and handle the machine as indicated.

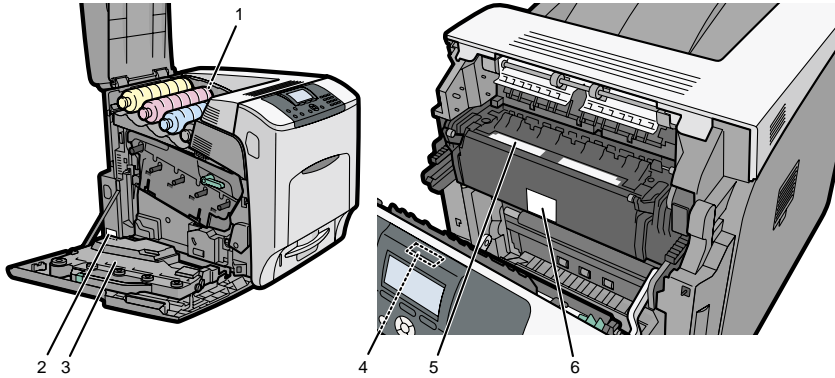

BYK001

1



BYK140

Do not incinerate spilled toner or used toner. Toner dust is flammable and might ignite when exposed to an open flame.

Disposal should take place at an authorized dealer or an appropriate collection site. If you dispose of the used toner containers yourself, dispose of them according to local regulations.

2



BYK144

The printer weights approximately 57 kg (126 lb.).

Four people are required to move the printer. Hold the inset grips located on both sides, and then lift it slowly. Lifting it carelessly or dropping it may cause an injury.

3



Do not incinerate used toner or toner containers. Toner dust might ignite when exposed to an open flame.

4



Some parts of the Transfer roller may be charged with high voltage, and pose electric shock hazard. Do not touch parts other than the ones specified in the maintenance guide.

5

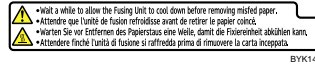
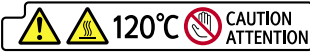

High temperature parts. Turn off the main power and be careful when replacing fusing unit/removing misfed paper.

6

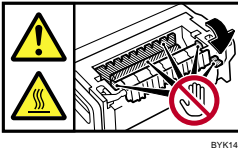

The inside of this printer becomes very hot. Do not touch parts labelled "△" (indicating a hot surface). Touching these parts will result in burns.

Power Switch Symbols

The meanings of the symbols for the switches on this machine are as follows:

- **I** :POWER ON.
- **O** :POWER OFF.
- **⏻** :STANDBY.

ENERGY STAR Program

ENERGY STAR® Program Requirements for Imaging Equipment



The ENERGY STAR® Program Requirements for Imaging Equipment encourage energy conservation by promoting energy efficient computers and other office equipment.

The program backs the development and dissemination of products that feature energy saving functions.

It is an open program in which manufacturers participate voluntarily.

Targeted products are computers, monitors, printers, facsimiles, copiers, scanners, and multi-function devices. Energy Star standards and logos are internationally uniform.

This machine is equipped with the following Energy Saver modes: Panel Off Mode, Energy Saver Mode, and Auto Off Mode. The machine recovers from Energy Saver mode when it receives a print job, or when the any key is pressed. For more information about how to configure Energy Saver modes, see “Making Printer Settings Using the Control Panel”, Software Guide as a HTML file on the CD-ROM.

❖ **Panel Off Mode**

The default delay time the machine waits before entering Panel Off Mode is 10 seconds. This default time can be changed.

❖ **Energy Saver Mode (Low Power Mode)**

If this machine remains idle for a specified period, it automatically reduces its electrical consumption.

The default delay time the machine waits before entering Energy Saver Mode is 1 minute. This default time can be changed.

❖ **Auto Off Mode (Sleep Mode)**

If this machine is already in Low Power mode and remains idle for a specified period, it automatically enters Sleep mode to further reduce its electrical consumption.

The default delay time the machine waits before entering Auto Off Mode 11 minutes. This default time can be changed.

The machine can print jobs from computers while in Sleep mode.

❖ Specifications

Panel Off Mode	Power Consumption	150 W or less
	Default Time	10 seconds
	Recovery Time	10 seconds
Energy Saver Mode (Low Power Mode)	Power Consumption	110 W or less
	Default Time	1 minute
	Recovery Time	Type 1: 24 seconds or less Type 2: 26 seconds or less
Auto Off Mode (Sleep Mode)	Power Consumption	6 W or less
	Default Time	11 minutes
	Recovery Time	Type 1: 47 seconds or less Type 2: 50 seconds or less

Recycled Paper

We recommend use of recycled paper which is environment friendly. Please contact your sales representative for recommended paper.

Informations générales

Introduction

Ce manuel contient des informations détaillées sur le fonctionnement de cet appareil et des remarques sur son utilisation. Pour votre sécurité, il est fortement conseillé de lire attentivement le présent manuel avant d'utiliser cet appareil. Conservez ce manuel dans un endroit accessible afin de pouvoir vous y reporter rapidement.

Important

Le contenu de ce manuel peut être sujet à des modifications sans avertissement préalable.

En aucun cas la société ne sera tenue responsable de dommages directs, indirects, particuliers, accessoires ou immatériels résultant du maniement ou du fonctionnement de l'appareil.

Remarques :

Il est possible que certaines illustrations du présent manuel ne correspondent pas tout à fait à l'appareil.

Certaines options ne sont pas disponibles dans certains pays. Pour plus d'informations, contactez votre revendeur local.

Selon votre pays de résidence, certaines unités peuvent être en option. Pour plus d'informations, contactez votre revendeur local.

Attention

Pour obtenir une bonne qualité d'impression, le fabricant recommande l'utilisation d'un toner d'origine.

Le fabricant ne peut être tenu pour responsable des dommages ou frais résultant de l'utilisation de pièces autres que les pièces du fabricant pour vos appareils bureautiques.

Remarques

Les noms des différents modèles d'appareil ne figurent pas dans les pages suivantes. Vous devez donc vérifier le type de votre appareil avant de lire ce manuel. (Pour plus d'informations, reportez-vous au Manuel du matériel sur le CD-ROM.)

- Type 1 : CLP37DN/SP C430DN/LP137CN/Aficio SP C430DN
- Type 2 : CLP42DN/SP C431DN/LP142CN/Aficio SP C431DN

Il est possible que certains modèles ne soient pas disponibles dans certains pays. Pour plus d'informations, contactez votre revendeur local.

Deux types d'unités de mesure sont utilisés dans ce manuel. Pour cet appareil, reportez-vous à la version utilisant des unités de mesure anglo-saxonne (inch).

Source d'alimentation

120 - 127 V, 50/60 Hz, 12 A ou plus

Veillez à raccorder le câble d'alimentation à une source d'alimentation conforme à la description ci-dessus.

Lois et réglementations

Interdiction prévue par la loi

Ne copiez ou n'imprimez pas des documents dont la reproduction est interdite par la loi.

Copier ou imprimer les éléments suivants est en règle générale interdit par les autorités locales :

billets de banques, timbres fiscaux, obligations, certificats d'actions, traites bancaires, chèques, passeports et permis de conduire.

La liste précédente est donnée à titre d'exemple et n'est en aucun cas exhaustive. Nous déclinons toute responsabilité en cas de liste incomplète ou inexacte. Si vous avez des questions concernant le droit de copier ou d'imprimer certains éléments, consultez un conseiller juridique.

Sécurité laser

Réglementations CDRH

Cet équipement est conforme aux exigences de CFR 21, sous-chapitre J, relatif aux dispositifs laser de classe 1.

Cet appareil comprend une diode laser AlGaInP, d'une puissance de 15 mW et d'une longueur d'onde de 657 à 663 nanomètres.

Cet appareil n'émet aucun faisceau lumineux dangereux, ce dernier étant complètement protégé, pour tous les modes de fonctionnement et de maintenance de l'utilisateur.

Précaution :

Recourir à toute autre procédure en termes de commandes, réglages ou performances, autre que celles décrites dans ce manuel peut vous exposer dangereusement à des radiations.

Règles FCC et IC

Avertissement :

Cet appareil est conforme à la partie 15 des Règles FCC et de la partie RSS-Gen des Règles IC.

L'utilisation est soumise aux deux conditions suivantes :

1. Cet appareil ne doit pas causer d'interférences nuisibles.
2. Cet appareil doit pouvoir recevoir toutes sortes d'interférences, y compris celles pouvant causer un fonctionnement indésirable.

Les changements ou modifications qui n'ont pas été explicitement approuvés par l'organisme responsable de la conformité peuvent annuler la capacité de l'utilisateur à utiliser l'équipement.

Ce périphérique ne doit pas se trouver dans le même lieu qu'une autre antenne ou un autre émetteur, ni être utilisé en conjonction avec eux, sauf pour le module LAN sans fil R-WL54CN (FCC ID : BBP-WLRWL541) pour lequel des tests d'utilisation conjointe ont été effectués.

Remarque destinée aux utilisateurs résidant aux États-Unis d'Amérique

Règles FCC

❖ Déclaration de conformité

Cet appareil est conforme à la partie 15 des Règles FCC.

L'utilisation est soumise aux deux conditions suivantes :

- (1) Cet appareil ne doit pas causer d'interférences nuisibles.
- (2) Cet appareil doit pouvoir recevoir toutes sortes d'interférences, y compris celles pouvant causer un fonctionnement indésirable.

Organisme responsable : Ricoh Americas Corporation.

Adresse : 5 Dedrick Place, West Caldwell, NJ 07006, USA

Numéro de téléphone : 973-882-2000

Nom du produit : imprimante laser

Numéro de modèle : CLP37DN/SP C430DN/LP137CN/Aficio SP C430DN
CLP42DN/SP C431DN/LP142CN/Aficio SP C431DN

❖ Remarque

Cet équipement a été testé et déclaré conforme aux limites pour un appareil numérique de classe B, conformément aux Règles FCC, partie 15. Ces limites sont conçues pour permettre une protection raisonnable contre les interférences nuisibles dans le cadre d'une installation résidentielle. Cet équipement génère, utilise et peut rayonner de l'énergie radiofréquence et peut engendrer des interférences nuisibles aux communications radio s'il n'est pas installé et utilisé conformément aux instructions. Cependant, il n'existe aucune garantie d'absence totale d'interférences pour une installation en particulier. Si cet équipement cause effectivement des interférences nuisibles à la réception radio ou télévision, chose qui peut être déterminée en éteignant puis allumant l'équipement, il est conseillé à l'utilisateur de supprimer l'interférence en prenant l'une ou plusieurs des mesures suivantes :

- Réorienter ou déplacer l'antenne réceptrice.
- Accroître la distance entre l'équipement et le récepteur.
- Raccorder l'équipement à une prise d'un circuit différent de celui du récepteur.
- Contacter le vendeur ou un technicien radio/TV confirmé.

❖ Attention

Les changements ou modifications qui n'ont pas été explicitement approuvés par l'organisme responsable de la conformité peuvent annuler la capacité de l'utilisateur à utiliser l'équipement.

Remarques sur la ou les lampes à l'intérieur cet appareil

LAMP(S) INSIDE THIS PRODUCT CONTAIN MERCURY AND MUST BE RECYCLED OR DISPOSED OF ACCORDING TO LOCAL, STATE OR FEDERAL LAWS.
--

Remarque destinée aux utilisateurs résidant dans l'état de Californie, États-Unis

Matériau contenant du perchlorate – traitement particulier possible, voir www.dtsc.ca.gov/hazardouswaste/perchlorate

Remarque concernant les utilisateurs au Canada

Avertissement

Cet appareil numérique de la classe B est conforme à la norme NMB-003 du Canada.

Remarque concernant les utilisateurs au Canada

Avertissement

Cet appareil numérique de la classe B est conforme à la norme NMB-003 du Canada.

Consignes de sécurité

Lors de l'utilisation de cet appareil, les précautions de sécurité suivantes doivent toujours être respectées.

Sécurité pendant l'utilisation

Dans ce manuel, les symboles importants suivants sont utilisés :

⚠ AVERTISSEMENT :

Indique une situation potentiellement dangereuse pouvant entraîner, en cas de non-respect des instructions, des blessures graves ou la mort.

⚠ PRÉCAUTION :

Indique une situation potentiellement dangereuse pouvant entraîner, en cas de non respect des instructions, des blessures superficielles ou des dégâts matériels.

Consignes de sécurité à respecter

Cette section décrit les consignes de sécurité à suivre impérativement lors de l'utilisation de cet appareil.

Environnements dans lesquels l'appareil peut être utilisé

Cette section décrit les consignes de sécurité relatives aux environnements dans lesquels l'appareil peut être utilisé.

⚠ AVERTISSEMENT :

- ***N'utilisez pas d'aérosols inflammables ou de solvants à proximité de l'appareil. Cela risque de provoquer un incendie ou une électrocution.***
- ***Ne placez pas de vases, de pots de fleur, de tasses, de produits de toilette, de médicaments, d'objets en métal de petite taille ou de récipients remplis d'eau ou de tout autre liquide, sur l'appareil ou à proximité de celui-ci. Si un liquide se renverse ou si de tels objets ou substances tombent dans l'appareil, il existe un risque d'incendie ou d'électrocution.***

⚠ PRÉCAUTION :

- ***Gardez l'appareil à l'écart de l'humidité et de la poussière. Sinon l'appareil présenterait un risque d'incendie ou d'électrocution.***

- *Ne placez pas l'appareil sur une surface instable ou inclinée. S'il tombe, vous risquez de vous blesser.*
- *Ne placez aucun objet lourd sur l'appareil. Si tel est le cas, cela peut faire basculer l'appareil et causer des blessures.*
- *Assurez-vous que la pièce dans laquelle vous utilisez l'appareil est spacieuse et correctement ventilée. Il est important de bien ventiler la pièce lorsque vous utilisez souvent l'appareil.*
- *N'obstruez pas les orifices de ventilation de l'appareil. Vous risquez de provoquer un incendie en raison de la surchauffe des composants internes.*
- *Lorsqu'ils sont neufs, les appareils électroniques contenant des produits volatils émettent habituellement des gaz dans l'air ambiant. Pour cette raison il convient, lors des quelques jours suivants l'installation de l'appareil, de ventiler abondamment la pièce dans laquelle il est placé.*
- *Des niveaux d'émission sonore de l'appareil dépassant LWAd > 63 dB (A) ne conviennent pas aux environnements de bureau, il convient donc de placer l'appareil dans une pièce distincte.*
- *La table anti-basculement à roulettes est nécessaire si l'imprimante est placée sur le sol avec l'unité d'alimentation de papier en option installée. Ne pas utiliser la table anti-basculement à roulettes présente un risque de blessures et de dommages matériels à l'imprimante en cas de chute. La table anti-basculement à roulettes doit être installée uniquement par un technicien. Contactez le SAV pour plus de détails.*

Remarque

- Pour éviter une possible accumulation d'ozone, veuillez à placer cet appareil dans une vaste pièce bien aérée dont le renouvellement d'air est supérieur à 30 m³/h/personne.

Manipulation des cordons et des prises d'alimentation

Cette section décrit les consignes de sécurité relatives à la manipulation des cordons et des prises d'alimentation.

AVERTISSEMENT :

- ***Si le cordon d'alimentation est endommagé et que ses fils sont visibles ou rompus, consultez le SAV pour le remplacer. L'utilisation de cordons d'alimentation endommagés risque de provoquer un incendie ou une électrocution.***

• **N'utilisez aucune source d'alimentation différente des caractéristiques indiquées dans le présent manuel. Cela risque de provoquer un incendie ou une électrocution.**

• **N'utilisez aucune fréquence différente des caractéristiques indiquées. Cela risque de provoquer un incendie ou une électrocution.**

• **N'utilisez pas d'adaptateurs multiprise. Cela risque de provoquer un incendie ou une électrocution.**

• **N'utilisez pas de rallonges. Cela risque de provoquer un incendie ou une électrocution.**

• **N'utilisez pas de cordons d'alimentation endommagés, rompus ou modifiés. De plus, n'utilisez pas de cordons d'alimentation qui ont été coincés sous des objets lourds, qui ont été tordus ou sur lesquels on a exercé une traction trop forte. Cela risque de provoquer un incendie ou une électrocution.**

• **Le fait de toucher les broches de la fiche du cordon d'alimentation avec un objet métallique présente un risque d'incendie ou d'électrocution.**

• **Le cordon d'alimentation fourni est destiné uniquement à cet appareil. Ne l'utilisez avec aucun autre appareil. Cela risque de provoquer un incendie ou une électrocution.**

• **Il est dangereux de manipuler la fiche du cordon d'alimentation avec les mains mouillées. Cela risque de provoquer une électrocution.**

⚠ PRÉCAUTION :

• **Veillez à enfoncer complètement la fiche du cordon d'alimentation dans la prise murale. Des fiches partiellement enfoncées constituent des connexions instables pouvant conduire à une accumulation dangereuse de chaleur.**

• **Si cet appareil n'est pas utilisé pendant une période prolongée, plusieurs jours ou plus, débranchez le cordon d'alimentation de la prise murale.**

• **Lorsque vous débranchez le cordon d'alimentation de la prise murale, tirez toujours sur la fiche et non sur le câble. Tirer sur le cordon peut endommager celui-ci. L'utilisation de cordons d'alimentation endommagés risque de provoquer un incendie ou une électrocution.**

- *Veillez à débrancher la fiche de la prise murale et nettoyer les broches, ainsi que la zone les entourant, au moins une fois par an. L'accumulation de poussière sur la fiche constitue un risque d'incendie.*

- *Lors de toute opération de maintenance sur l'appareil, débranchez toujours le cordon d'alimentation de la prise murale.*

Manipulation de l'appareil principal

Cette section décrit les consignes de sécurité relatives à la manipulation de l'appareil principal.

⚠ AVERTISSEMENT :

- *Veillez à placer l'appareil le plus près possible d'une prise murale. Ceci permet de débrancher facilement le cordon d'alimentation en cas d'urgence.*

- *Si l'appareil laisse échapper de la fumée ou une forte odeur, ou s'il fonctionne de manière inhabituelle, il vous faut immédiatement le mettre hors tension en appuyant sur l'interrupteur d'alimentation principale. Une fois l'appareil hors tension, veillez à débrancher la fiche du cordon d'alimentation depuis la prise murale. Consultez alors le SAV et indiquez-lui le problème. N'utilisez pas l'appareil. Cela risque de provoquer un incendie ou une électrocution.*

- *Si de l'eau, ou tout autre liquide, se déverse dans l'appareil, ou si un objet métallique tombe à l'intérieur de celui-ci, il vous faut immédiatement le mettre hors tension en appuyant sur l'interrupteur d'alimentation principale. Une fois l'appareil hors tension, veillez à débrancher la fiche du cordon d'alimentation depuis la prise murale. Consultez alors le SAV ou votre commercial et indiquez-lui le problème. N'utilisez pas l'appareil. Cela risque de provoquer un incendie ou une électrocution.*

- *Si l'appareil tombe, ou si un capot, ou toute autre partie, se casse, vous devez couper l'interrupteur d'alimentation principale et débrancher la fiche du cordon d'alimentation de la prise murale. Consultez alors le SAV et indiquez-lui le problème. N'utilisez pas l'appareil. Cela risque de provoquer un incendie ou une électrocution.*

- *Ne touchez pas cet appareil en cas de foudroiement à proximité. Cela risque de provoquer une électrocution.*

- *Conservez à tout moment les matériaux en polyéthylène (sachets, etc.) fournis avec cet appareil hors de portée des bébés et enfants en bas âge. Le fait de porter ces matériaux en polyéthylène à la bouche ou au nez peuvent causer un étouffement.*

⚠ PRÉCAUTION :

- *Débranchez le cordon d'alimentation de la prise de courant murale avant de déplacer l'appareil. Lors du déplacement de l'appareil, vous devez vous assurer que le cordon d'alimentation n'est pas endommagé sous l'appareil. Le non-respect de ces consignes de sécurité risque de provoquer un incendie ou une électrocution.*
- *Avant d'installer ou de retirer des options, débranchez toujours les cordons d'alimentation des prises murales et laissez l'unité principale refroidir. Le non-respect de ces consignes de sécurité risque de provoquer des brûlures.*
- *Pour des raisons écologiques, ne vous débarrassez pas de l'appareil ou des consommables usagés aux points de collecte des déchets ménagers. La mise au rebut peut s'effectuer auprès d'un revendeur agréé.*
- *Lorsque vous déplacez l'appareil, saisissez les poignées encastrées des deux côtés et soulevez doucement l'imprimante. Soulever l'imprimante sans précautions ou la faire tomber peut causer des blessures.*

⚙ Important

- Tension nominale du connecteur pour les options : max. 24 V c.c.
- La tension ne doit pas varier de plus de 10 %.

Manipulation de l'intérieur de l'appareil

Cette section décrit les consignes de sécurité relatives à la manipulation de l'intérieur de l'appareil.

⚠ AVERTISSEMENT :

- ***Enlevez uniquement les capots ou vis explicitement indiqués dans ce manuel. À l'intérieur de cet appareil se trouvent des composants à haute tension pouvant présenter des risques d'électrocution ainsi que des composants laser pouvant causer une cécité. Contactez le SAV ou votre commercial si l'un des composants internes nécessite une maintenance, un réglage ou une réparation.***
- ***N'essayez pas de démonter ou de modifier cet appareil. Cela risque de provoquer des brûlures et une électrocution. Nous rappelons que l'exposition aux composants laser à l'intérieur de cet appareil peut provoquer une cécité.***

⚠ PRÉCAUTION :

- *Certains composants internes de cet appareil peuvent devenir très chauds. Pour cette raison, soyez prudent lorsque vous retirez du papier coincé. Dans le cas contraire, vous pouvez vous brûler.*

• *L'unité de fusion peut être très chaude. Lors du retrait de feuilles coincées, veillez à ne pas toucher l'unité de fusion.*

• *L'intérieur de l'appareil peut être très chaud. Ne touchez pas les pièces munies d'une étiquette indiquant « surface chaude ». Dans le cas contraire, vous risquez de vous blesser.*

• *Lors du chargement de papier, soyez prudent à ne pas vous coincer ou vous blesser les doigts.*

• *Durant le fonctionnement, les rouleaux pour le transport du papier et des originaux tournent. Un dispositif de sécurité a été installé de sorte que l'appareil puisse être utilisé en toute sécurité. Cependant, veillez à ne pas toucher l'appareil durant le fonctionnement. Dans le cas contraire, vous risquez de vous blesser.*

• *Si l'intérieur de l'appareil n'est pas régulièrement nettoyé, la poussière risque de s'y accumuler. L'accumulation de poussière dans l'appareil peut provoquer un incendie ou un dysfonctionnement. Contactez le SAV ou votre commercial pour obtenir des informations sur le nettoyage de l'intérieur de l'appareil et sur le coût de cet entretien.*

• *Ne tirez pas avec force sur le magasin papier. Si c'est le cas, le magasin risque de tomber et de causer des blessures.*

• *Ne touchez pas la partie interne du compartiment de la carte contrôleur. Cela risque de provoquer un dysfonctionnement ou des brûlures.*

• *Il existe un risque d'explosion si la batterie est remplacée par un type incorrect. Veuillez mettre les batteries usagées au rebut selon les instructions données.*

Manipulation des consommables de l'appareil

Cette section décrit les consignes de sécurité relatives à la manipulation des consommables de l'appareil.

⚠ AVERTISSEMENT :

• ***Ne brûlez pas le toner (usagé ou neuf) ou les récipients de toner. Vous risqueriez de vous brûler. Le toner s'enflamme au contact d'une flamme nue.***

• ***Ne stockez pas le toner (usagé ou neuf) ou les récipients de toner près de flammes nues. Vous risqueriez de vous brûler et de provoquer un incendie. Le toner s'enflamme au contact d'une flamme nue.***

- **Conservez à tout moment les matériaux en polyéthylène (sachets, gants, etc.) fournis avec cet appareil hors de portée des bébés et enfants en bas âge. Le fait de porter ces matériaux en polyéthylène à la bouche ou au nez peuvent causer un étouffement.**

⚠ PRÉCAUTION :

- *N'écrasez ou ne comprimez pas les récipients de toner. Le cas échéant, le toner peut se renverser, salissant vos vêtements, votre peau et le sol, et entraînant éventuellement une ingestion accidentelle.*
- *Conservez le toner (usagé ou non) ainsi que les cartouches de toner hors de portée des enfants.*
- *En cas d'inhalation de toner usagé ou non, rincez-vous abondamment la bouche avec de l'eau et rendez-vous dans un endroit frais.*
- *Si du toner, usagé ou non, entre en contact avec vos yeux, rincez-les immédiatement avec beaucoup d'eau. Consultez un médecin si nécessaire.*
- *Si vous avalez du toner, usagé ou non, diluez la quantité avalée en buvant beaucoup d'eau. Consultez un médecin si nécessaire.*
- *Lorsque vous retirez du papier coincé ou remplacez le toner, évitez de répandre du toner (neuf ou usagé) sur vos vêtements. En cas de contact du toner avec vos vêtements, lavez la zone affectée à l'eau froide. L'eau chaude fixe le toner dans le tissu et empêche d'éliminer la tache.*
- *Lorsque vous retirez du papier coincé ou remplacez le toner, évitez de répandre du toner (neuf ou usagé) sur votre peau. En cas de contact du toner avec la peau, lavez abondamment la zone affectée avec de l'eau et du savon.*
- *N'utilisez aucun autre type de papier conducteur. Vous risqueriez de provoquer un incendie.*

Étiquettes de sécurité de cet appareil

Cette section détaille les étiquettes d'informations de sécurité de l'appareil.

Emplacements des étiquettes ⚠️ AVERTISSEMENT et ⚠️ PRÉCAUTION

Cet appareil présente des étiquettes ⚠️ AVERTISSEMENT et ⚠️ ATTENTION aux endroits indiqués ci-dessous. Pour une sécurité maximale, veuillez suivre les instructions et manipuler l'appareil comme indiqué.

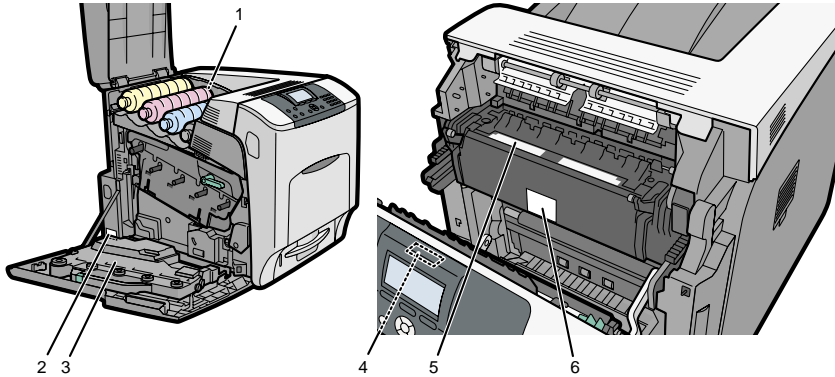

1



N'incinerez pas de toner renversé ou usagé. La poussière de toner est inflammable et risque de s'enflammer en cas d'exposition à une flamme nue.

La mise au rebut doit s'effectuer chez un distributeur agréé ou dans les lieux de collecte appropriés.

Si vous mettez vous-même au rebut des conteneurs de toner usagés, respectez les règlements locaux.

2

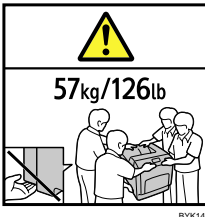

L'imprimante pèse environ 57 kg (126 lb.).

Il faut quatre personnes pour déplacer l'imprimante. Saisissez les poignées encastrées des deux côtés et soulevez doucement l'imprimante. Vous pouvez vous blesser si vous soulevez l'imprimante sans précautions ou si vous la faites tomber.

3



BKY202

Ne brûlez pas le toner usagé ou les récipients de toner. La poussière de toner risque de s'enflammer en cas d'exposition à une flamme nue.

4



BYK147

Certaines pièces placées sur le rouleau de transfert peuvent présenter de hautes tensions et provoquer des risques d'électrocution. Ne touchez que les pièces explicitement spécifiées dans le Manuel d'entretien.

5

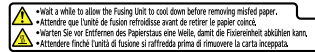
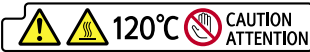

BYK146

Pièces très chaudes. Mettez l'appareil hors tension et soyez prudent lors du remplacement de l'unité de fusion et du retrait de papier coincé.

6

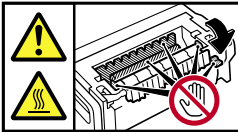

BYK145

La partie intérieure de cette imprimante peut être très chaude. Ne touchez pas les parties étiquetées « ⚠ » (surface chaude). Toucher ces pièces entraîne des brûlures.

Symboles pour l'interrupteur principal

Vous trouverez ci-après la signification des symboles apposés sur les interrupteurs de cet appareil :

- **I** : MISE SOUS TENSION.
- **O** : MISE HORS TENSION.
- **⏻** : VEILLE.

Programme ENERGY STAR

Directives du programme ENERGY STAR® relatives à l'équipement d'imagerie



Les directives du programme ENERGY STAR® relatives à l'équipement d'imagerie encouragent les économies d'énergie en favorisant les ordinateurs et équipements bureautiques économes.

Ce programme soutient le développement et la diffusion de produits qui comportent des fonctions d'économies d'énergie.

Il s'agit d'un programme ouvert auquel les fabricants participent volontairement.

Les produits ciblés sont les ordinateurs, les moniteurs, les imprimantes, les télécopieurs, les photocopieurs, les scanners et les périphériques multifonction. Les normes et logos Energy Star sont les mêmes dans le monde entier.

Cet appareil présente les modes Économie d'énergie suivants : mode Arrêt écran, mode Éco. énergie et mode Arrêt auto. Cet appareil quitte le mode Éco. énergie sur réception d'un travail d'impression ou lorsqu'une touche est enfoncée. Pour plus d'informations sur la manière de configurer les modes Éco. énergie, reportez-vous au Manuel du logiciel, sous forme de fichier HTML sur le CD-ROM.

❖ Mode Arrêt écran

Le délai par défaut avant de passer en mode Arrêt écran est de 10 secondes. Ce délai par défaut peut être modifié.

❖ Mode Éco. énergie (mode basse consommation)

Si l'appareil est inutilisé pendant une durée prédéfinie, il réduit automatiquement sa consommation électrique.

Le délai par défaut avant de passer en mode Éco. énergie est de 1 minute. Ce délai par défaut peut être modifié.

❖ Mode Arrêt auto (mode veille)

Si cet appareil est déjà en mode basse consommation et est inutilisé pendant une durée prédéfinie, il passe automatiquement en mode veille pour réduire davantage sa consommation électrique.

Le délai par défaut avant de passer en mode Arrêt auto est de 11 minutes. Ce délai par défaut peut être modifié.

Cet appareil peut imprimer des travaux d'impression provenant d'ordinateurs, tout en étant en mode veille.

❖ Caractéristiques

Mode Arrêt écran	Consommation d'énergie	Moins de 150 W
	Délai par défaut	10 secondes
	Temps de reprise	10 secondes
Mode Éco. énergie (mode basse consommation)	Consommation d'énergie	Moins de 110 W
	Délai par défaut	1 minute
	Temps de reprise	Type 1 : moins de 24 secondes Type 2 : moins de 26 secondes
Mode Arrêt auto (mode veille)	Consommation d'énergie	Moins de 6 W
	Délai par défaut	11 minutes
	Temps de reprise	Type 1 : moins de 47 secondes Type 2 : moins de 50 secondes

Papier recyclé

Nous vous recommandons l'utilisation de papier recyclé, ceci constitue un geste écologique. Veuillez prendre contact avec votre commercial qui vous recommandera le papier adapté.

Información

Introducción

Este manual contiene instrucciones detalladas sobre el funcionamiento e información acerca del uso de esta máquina. Para su seguridad, lea este manual detenidamente antes de utilizar la máquina. Conserve este manual a mano para futuras consultas.

Importante

Los contenidos de este manual están sujetos a cambio sin previo aviso.

En ningún caso la compañía será responsable de posibles daños directos, indirectos, especiales, accidentales o consiguientes como resultado de la manipulación o manejo de la máquina.



Notas:

Algunas ilustraciones del manual pueden diferir ligeramente de su máquina.

Ciertas opciones pueden no estar disponibles en algunos países. Para más detalles, consulte a su distribuidor local.

En función de su país, determinadas unidades pueden ser opcionales. Para más detalles, consulte a su distribuidor local.



Precaución

Para conseguir una buena calidad de impresión, el fabricante recomienda que utilice sus tóneres originales.

El fabricante no asume ninguna responsabilidad por cualquier daño o gasto ocasionado por el uso de piezas no originales del fabricante en este producto de oficina.

Notas

Los nombres de modelo de las máquinas no aparecen en las siguientes páginas. Compruebe su máquina antes de leer este manual. (Para obtener más información, consulte en el Manual de hardware del CD-ROM.)

- Tipo 1: CLP37DN/SP C430DN/LP137CN/Aficio SP C430DN
- Tipo 2: CLP42DN/SP C431DN/LP142CN/Aficio SP C431DN

Determinados tipos de máquina pueden no estar disponibles en algunos países. Para más detalles, consulte a su distribuidor local.

En este manual se emplean dos tipos de unidades de medida. Para esta máquina, consulte la versión en pulgadas.

Fuente de alimentación

120 - 127 V, 50/60 Hz, 12 A o más

Asegúrese de conectar el cable de alimentación a una fuente de alimentación del tipo arriba indicado.

Leyes y normativas

Prohibición legal

No realice copias ni imprima ningún artículo cuya reproducción esté prohibida por la ley.

La copia o la impresión de los siguientes artículos, normalmente está prohibida por la ley:

billetes bancarios, timbres fiscales, bonos, certificados de acciones, efectos bancarios, cheques, pasaportes y permisos de conducir.

La lista anterior es tan solo una guía orientativa y no contiene todas las prohibiciones. No asumimos responsabilidad alguna relacionada con su precisión e integridad. Si tiene alguna pregunta relacionada con la legalidad de copiar o imprimir ciertos artículos, póngase en contacto con su asesor legal.

Seguridad del láser

Normativas CDRH

Este equipo cumple con los requisitos de 21 CFR, subapartado J, para los productos láser clase 1.

Este equipo contiene un diodo láser AlGaInP, de 15 miliwatt y 657-663 de longitud de onda.

Este equipo no emite radiaciones peligrosas, ya que el haz luminoso está totalmente protegido durante los modos de funcionamiento y mantenimiento.

Precaución:

El control, los ajustes o el uso de las funciones de la máquina de manera distinta a la especificada en este manual puede provocar la exposición a radiaciones peligrosas.

Normas de la FCC e IC

Advertencia:

Este dispositivo cumple con el apartado 15 de las normas de la FCC y con el apartado RSS-Gen de las normas de IC.

El funcionamiento depende de las dos condiciones siguientes:

1. Este dispositivo no puede provocar interferencias peligrosas; y
2. Este dispositivo debe aceptar todas las interferencias recibidas, incluso las que provoquen problemas de funcionamiento.

Los cambios o modificaciones sin la autorización explícita de la parte responsable del cumplimiento normativo pueden invalidar la autorización del usuario para utilizar el equipo.

Este dispositivo no debe ubicarse ni utilizarse junto a ninguna otra antena ni transmisor, excepto con el módulo de LAN inalámbrica R-WL54MN (FCC ID: BBP-WLRWL541) para el que se han realizado pruebas de ubicación conjunta.

Nota a los usuarios de Estados Unidos

Normas de la FCC

❖ Declaración de conformidad

Este dispositivo cumple con el apartado 15 de las normas de la FCC.

El funcionamiento depende de las dos condiciones siguientes:

- (1) Este dispositivo no puede provocar interferencias peligrosas; y
- (2) Este dispositivo debe aceptar todas las interferencias recibidas, incluso las que provoquen problemas de funcionamiento.

Parte responsable: Ricoh Americas Corporation.

Dirección: 5 Detrick Place, West Caldwell, NJ 07006

Teléfono: 973-882-2000

Nombre del producto: impresora láser

Número de modelo: CLP37DN/SP C430DN/LP137CN/Aficio SP C430DN
CLP42DN/SP C431DN/LP142CN/Aficio SP C431DN

❖ Nota

Este equipo se ha sometido a pruebas que acreditan su conformidad con los límites establecidos para los dispositivos digitales de clase B, según el apartado 15 de las normas de la FCC. Estos límites están pensados para ofrecer una protección suficiente contra las interferencias peligrosas en instalaciones residenciales. Este aparato genera, utiliza y puede emitir energía de radiofrecuencia y, si no se instala y se utiliza de conformidad con las instrucciones, podría provocar interferencias en las comunicaciones por radio. Sin embargo, no se garantiza la ausencia de interferencias en una instalación concreta. Si el equipo provoca interferencias en la recepción de radio o televisión (que podrá determinar encendiendo y apagando el equipo), el usuario puede tratar de corregir las interferencias adoptando alguna de las siguientes medidas:

- Cambie la orientación o la posición de la antena de recepción.
- Aumente la distancia que separa el equipo y el receptor.
- Conecte el equipo a una toma de un circuito diferente del circuito al que se conecta el receptor.
- Consulte con el distribuidor o con un técnico de radio o televisión experimentado.

❖ Precaución

Los cambios o modificaciones sin la autorización explícita de la parte responsable del cumplimiento normativo pueden invalidar la autorización del usuario para utilizar el equipo.

Notas sobre las luces del interior de la máquina

LAMP(S) INSIDE THIS PRODUCT CONTAIN MERCURY AND MUST BE RECYCLED OR DISPOSED OF ACCORDING TO LOCAL, STATE OR FEDERAL LAWS.

Notas a los usuarios del estado de California

Los material de perclorato deben manipularse con especial atención. Consulte www.dtsc.ca.gov/hazardouswaste/perchlorate.

Nota a los usuarios de Canadá

Nota

Este dispositivo digital de clase B cumple con la norma canadiense ICES-003.

Remarque concernant les utilisateurs au Canada

Avertissement

Cet appareil numérique de la classe B est conforme à la norme NMB-003 du Canada.

Información de seguridad

Al utilizar la máquina, siempre debe tener presente las siguientes precauciones de seguridad.

Seguridad durante el funcionamiento

En este manual, se utilizan los siguientes símbolos principales:

⚠ ADVERTENCIA:

Indica una situación potencialmente peligrosa que, de no seguirse las instrucciones, podría provocar la muerte o daños físicos graves.

⚠ PRECAUCIÓN:

Indica una situación potencialmente peligrosa que, de no seguirse las instrucciones, podría provocar lesiones leves o moderadas o daños materiales.

Precauciones de seguridad

Este apartado explica las precauciones de seguridad que deben seguirse siempre al utilizar esta máquina.

Entornos en los que puede utilizarse la máquina

Este apartado explica las precauciones de seguridad relacionadas con los entornos en los que puede utilizarse la máquina.

⚠ ADVERTENCIA:

- **No utilice aerosoles ni disolventes inflamables cerca de la máquina. Hacerlo podría provocar una descarga eléctrica o un incendio.**
- **No coloque jarrones, macetas, vasos, artículos de aseo, medicamentos, objetos metálicos pequeños o recipientes con agua o líquidos encima de la máquina o en sus proximidades. Si se derrama líquido o si los objetos o su contenido caen en la máquina podría producirse un incendio o una descarga eléctrica.**

⚠ PRECAUCIÓN:

- *Mantenga la máquina alejada de la humedad y el polvo. Si no lo hace podría producirse una descarga eléctrica o un incendio.*
- *No coloque la máquina en una superficie inestable o inclinada. Si vuelca, pueden producirse lesiones.*

• *No coloque objetos de peso sobre la máquina. De lo contrario, la máquina podría caerse y provocar daños físicos.*

• *Verifique que la sala en la que se utiliza la máquina es espaciosa y está bien ventilada. Una buena ventilación resulta especialmente importante si la máquina se utiliza con mucha frecuencia.*

• *No bloquee los orificios de ventilación de la máquina. De hacerlo, podría producirse un incendio a causa del sobrecalentamiento de los componentes internos.*

• *Los dispositivos eléctricos nuevos con materiales volátiles normalmente desprenden emisiones en sus inmediaciones. Por este motivo, tras la instalación de un nuevo dispositivo y durante los primeros días es necesario que la ventilación en el lugar de instalación sea abundante.*

• *Los niveles de sonido de la máquina, superiores a LWAd > 63 dB (A), no son adecuados para entornos de oficina, por lo que deberá instalar la máquina en otra sala.*

• *Es necesaria la mesa con ruedas antivuelco si va a instalarse la impresora en el suelo junto con la unidad de alimentación de papel opcional. Si no se utiliza este complemento, aumenta el riesgo de daños físicos o materiales provocados por una caída de la impresora. La mesa con ruedas antivuelco solo puede instalarla por un técnico de servicio. Póngase en contacto con su representante de servicio técnico para obtener más información.*

Nota

- Para evitar la posible acumulación de ozono, asegúrese de colocar la máquina en una sala amplia y bien ventilada con una renovación del aire de más de 30 m³/h/persona.

Manipulación de cables y enchufes eléctricos

Este apartado presenta las precauciones de seguridad relacionadas con la manipulación de cables y enchufes eléctricos.

ADVERTENCIA:

• ***Si el cable de alimentación está dañado y sus alambres internos quedan expuestos o rotos, póngase en contacto con un representante de servicio técnico para obtener uno de repuesto. Si utiliza cables de alimentación estropeados podría provocar un incendio o una descarga eléctrica.***

• **No utilice fuentes de alimentación que no se ajusten a las especificaciones indicadas en este manual. Hacerlo podría provocar una descarga eléctrica o un incendio.**

• **No utilice frecuencias que no se ajusten a las especificaciones indicadas en este manual. Hacerlo podría provocar una descarga eléctrica o un incendio.**

• **No utilice adaptadores de múltiples tomas. Hacerlo podría provocar una descarga eléctrica o un incendio.**

• **No utilice cables alargadores. Hacerlo podría provocar una descarga eléctrica o un incendio.**

• **No utilice cables de alimentación dañados, rotos o modificados. No utilice tampoco cables que hayan quedado atrapados bajo objetos pesados, doblados o de los que se ha tirado con fuerza. Hacerlo podría provocar una descarga eléctrica o un incendio.**

• **Touchar las puntas del enchufe del cable de alimentación con objetos metálicos acarrea riesgos de incendio o de descarga eléctrica.**

• **El cable de alimentación suministrado solo puede utilizarse con esta máquina. No lo utilice con otros dispositivos. Hacerlo podría provocar una descarga eléctrica o un incendio.**

• **Nunca manipule el enchufe del cable de alimentación con las manos mojadas. Hacerlo podría provocar una descarga eléctrica.**

⚠ PRECAUCIÓN:

• **Introduzca el enchufe del cable de alimentación totalmente en la toma de la pared. Un enchufe mal introducido puede generar inestabilidades, con el consiguiente riesgo de una acumulación excesiva de calor.**

• **Si no va a utilizar la máquina durante varios días, desconecte el cable de alimentación de la red.**

• **Cuando desconecte el cable de alimentación de la red, tire siempre del enchufe, nunca del cable. Si tira del cable, el cable podría estropearse. Si utiliza cables de alimentación estropeados podría provocar un incendio o una descarga eléctrica.**

• **Desconecte la clavija de la toma y limpie las puntas y su alrededor por lo menos una vez al año. La acumulación de polvo en un enchufe representa un riesgo de incendio.**

- *Si realiza operaciones de mantenimiento en la máquina, desconecte siempre el cable de alimentación de la red.*

Manipulación de la máquina principal

Este apartado presenta las precauciones de seguridad relacionadas con la manipulación de la máquina principal.

⚠ ADVERTENCIA:

- ***Coloque la máquina lo más cerca posible de una toma eléctrica. De este modo podrá desconectar fácilmente el cable de alimentación en caso de emergencia.***
- ***Si la máquina desprende humo o malos olores, o si presenta un comportamiento poco habitual, debe apagarla de inmediato mediante el interruptor de alimentación. Tras apagarla, desconecte el cable de alimentación de la toma de red. Seguidamente, póngase en contacto con un representante de servicio técnico y notifíquelo el problema. Entretanto, no utilice la máquina. Hacerlo podría provocar una descarga eléctrica o un incendio.***
- ***Si penetran en la máquina objetos metálicos, agua u otros líquidos, debe apagarla de inmediato mediante el interruptor de alimentación. Tras apagarla, desconecte el cable de alimentación de la toma de red. Seguidamente, póngase en contacto con un representante de servicio técnico y notifíquelo el problema. Entretanto, no utilice la máquina. Hacerlo podría provocar una descarga eléctrica o un incendio.***
- ***Si la máquina se cae, o si se rompe una tapa u otro componente, debe apagar el interruptor de alimentación y desconectar el cable de la toma de red. Seguidamente, póngase en contacto con un representante de servicio técnico y notifíquelo el problema. Entretanto, no utilice la máquina. Hacerlo podría provocar una descarga eléctrica o un incendio.***
- ***No toque la máquina si ha caído un rayo en una zona próxima. Hacerlo podría provocar una descarga eléctrica.***
- ***Mantenga los materiales de polietileno (como bolsas, etc.) suministrados con la máquina siempre alejados de niños y bebés. Si dichos materiales entran en contacto con la boca o la nariz, existe riesgo de asfixia.***

⚠ PRECAUCIÓN:

- *Desenchufe el cable de alimentación de la toma de tierra antes de mover la máquina. Mientras la mueve, tenga cuidado de que el cable de corriente no quede debajo de la máquina, ya que podría resultar dañado. Si no toma estas precauciones, podría provocar un incendio o una descarga eléctrica.*
- *Antes de instalar o desinstalar opciones, desconecte siempre los cables de alimentación de la red y deje que la unidad principal se enfríe totalmente. Si no sigue estas precauciones, podría sufrir quemaduras.*
- *Por razones ecológicas, no deseche la máquina ni los consumibles gastados en los puntos de recogida de residuos urbanos habituales. El desecho puede realizarse en un distribuidor autorizado.*
- *Al trasladar la máquina, sujétela por los agarres en ambos lados y, seguidamente, levántela poco a poco. Si la levanta de forma brusca o la deja caer, podría provocar daños físicos.*

⚙ Importante

- Tensión nominal del conector de las opciones: máx. 24 V CC
- La tensión no debe fluctuar más del 10%.

Manipulación del interior de la máquina

Este apartado presenta precauciones de seguridad relacionadas con la manipulación del interior de la máquina.

⚠ ADVERTENCIA:

- ***No retire tapas ni tornillos si no se indica explícitamente en el presente manual. El interior de la máquina contiene componentes de alto voltaje, que pueden representar un riesgo de descarga eléctrica, y componentes láser, potencialmente peligrosos para la vista. Si uno de los componentes internos de la máquina debe ajustarse o repararse, póngase en contacto con su representante comercial o de servicio técnico.***
- ***No intente desmontar la máquina ni modificarla. De lo contrario, se expone a sufrir quemaduras o una descarga eléctrica. La exposición a los componentes láser del interior de la máquina puede provocar ceguera.***

⚠ PRECAUCIÓN:

- *Algunos de los componentes internos de la máquina alcanzan temperaturas muy elevadas. Por este motivo, debe extremar las precauciones al retirar papel atascado. De lo contrario, podría sufrir quemaduras.*

• *La zona de fijación podría estar muy caliente. Al retirar papeles atascados, tenga mucho cuidado de no tocar la zona de fijación.*

• *El interior de la máquina puede estar muy caliente. No toque las partes identificadas con la etiqueta "hot surface" (superficie caliente). Si lo hace podría resultar herido.*

• *Al cargar el papel, extreme las precauciones para evitar que le queden los dedos atrapados.*

• *Durante el funcionamiento de la máquina, los rodillos de transporte del papel y los originales giran. La máquina dispone de un mecanismo de seguridad que garantiza una protección total. Sin embargo, no toque la máquina mientras esté en marcha. Si lo hace podría resultar herido.*

• *Si el interior de la máquina no se limpia periódicamente, es posible que se acumule el polvo. La acumulación excesiva de polvo en el interior de la máquina podría provocar incendios o averías. Consulte con un comercial con el servicio técnico para obtener información sobre el procedimiento y las tarifas para limpiar el interior de la máquina.*

• *No fuerce la bandeja de papel para extraerla. Si lo hace, la bandeja podría caerse y provocar daños físicos.*

• *No toque el interior del compartimento de la placa de controladores. Si lo hace, podría provocar una avería o sufrir una quemadura.*

• *Existe riesgo de explosión si cambia la batería por un tipo incorrecto. Deseche las baterías usadas según lo establecido en las instrucciones.*

Manipulación de los consumibles de la máquina

Este apartado presenta las precauciones de seguridad relacionadas con la manipulación de los consumibles de la máquina.

ADVERTENCIA:

• ***No queme el tóner (nuevo o usado) ni los contenedores de tóner. Si lo hace, podría sufrir quemaduras. El tóner explotará si entra en contacto con una llama abierta.***

• ***No guarde el tóner (nuevo o usado) ni los contenedores de tóner en lugares cerca de llamas abiertas. Si lo hace, podría sufrir quemaduras o provocar un incendio. El tóner explotará si entra en contacto con una llama abierta.***

- **Mantenga los materiales de polietileno (como bolsas o guantes) suministrados con la máquina siempre alejados de niños y bebés. Si dichos materiales entran en contacto con la boca o la nariz, existe riesgo de asfixia.**

⚠ PRECAUCIÓN:

- *No rompa ni presione los contenedores de tóner. Si lo hace, podría vertirse el tóner y manchar la piel, la ropa o el suelo e incluso provocar una ingesta accidental.*
- *Mantenga el tóner (usado o sin usar) y los contenedores fuera del alcance de los niños.*
- *Si se inhalara el contenido del tóner, haga gárgaras con mucha agua y váyase a un ambiente con aire fresco. Consulte a un médico si fuera necesario.*
- *Si le entra tóner o tóner usado en los ojos, lávelos inmediatamente con abundante agua. Consulte a un médico si fuera necesario.*
- *Si el tóner o el tóner usado se ingirieran, disuélvalo bebiendo abundante agua. Consulte a un médico si fuera necesario.*
- *Al retirar papel atascado o sustituir el tóner, procure no mancharse la ropa. Si el tóner entra en contacto con la ropa, limpie la zona afectada con agua fría. Si se usa agua caliente, el tóner quedará fijado a la ropa y puede que no se quite la mancha.*
- *Al retirar papel atascado o sustituir el tóner, procure no mancharse la piel. Si el tóner entra en contacto con la piel, lave la zona afectada con agua abundante y jabón.*
- *No utilice ningún otro tipo de papel conductivo. Si lo hace, podría provocar un incendio.*

Etiquetas de seguridad de la máquina

Este apartado explica las etiquetas de información de seguridad de la máquina.

Posición de las etiquetas de **⚠ADVERTENCIA** y **⚠PRECAUCIÓN**

Esta máquina dispone de etiquetas de **⚠ADVERTENCIA** y **⚠PRECAUCIÓN** en los siguientes lugares. Por su seguridad, siga las instrucciones y manipule la máquina tal como se indica.

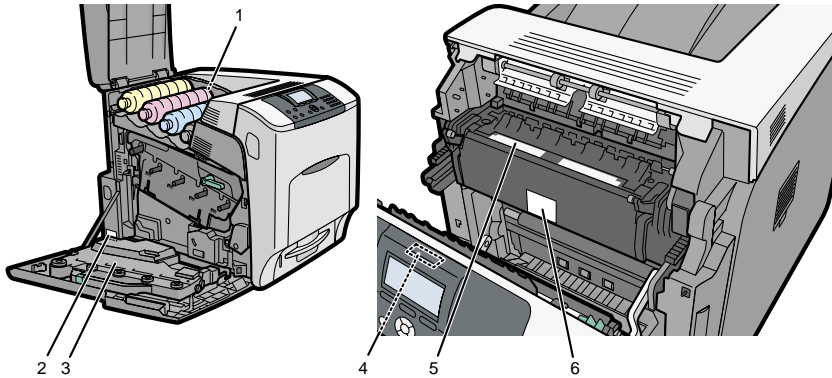

BYK001

1



BYK140

No quemé el tóner vertido ni el usado. El polvo del tóner es inflamable y puede arder en caso de ser expuesto a una llama.

Para su eliminación, diríjase a un distribuidor autorizado o un punto de recogida selectiva.

Si elimina los contenedores de tóner usado por su cuenta, hágalo de conformidad con las normativas de su municipio.

2



BYK144

La impresora pesa aproximadamente 57 kg.

Son necesarias cuatro personas para transportar la impresora. Sujétela por los agarres en ambos lados y, seguidamente, levántela poco a poco. Si la levanta de forma brusca o la deja caer, podría provocar daños físicos.

3



BKY202

No queme el tóner usado ni los contenedores de tóner. El polvo del tóner puede arder en caso de ser expuesto a una llama.

4



BYK147

Es posible que algunas partes del rodillo de transferencia tengan una tensión elevada y constituyan un riesgo de descarga eléctrica. No toque más zonas que las especificadas en el manual de mantenimiento.

5

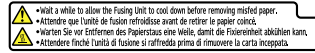
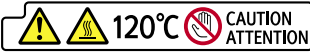

BYK146

Zonas con temperaturas elevadas. Apague la máquina y exteme las precauciones al sustituir la unidad de fusión o retirar papel atascado.

6

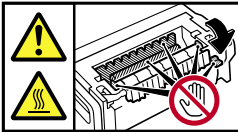

BYK145

El interior de la impresora alcanza temperaturas muy elevadas. No toque las zonas con la marca “⚠” (que identifica una superficie caliente). Si lo hace, podría sufrir quemaduras.

Símbolos del interruptor de alimentación

El significado de los símbolos de los botones de esta máquina es el siguiente:

- | : ENCENDIDA.
- ○ : APAGADA.
- ⏻ : EN ESPERA.

Programa ENERGY STAR

Requisitos del programa ENERGY STAR® para los equipos de visualización



Los requisitos del programa ENERGY STAR® para dispositivos de visualización fomentan el ahorro energético al impulsar los ordenadores y dispositivos informáticos de bajo consumo de energía.

El programa contribuye al desarrollo y la difusión de productos con funciones de ahorro de energía.

Se trata de un programa abierto en el que los fabricantes participan de forma voluntaria.

El programa está pensado para ordenadores, pantallas, impresoras, faxes, fotocopiadoras, escáneres y dispositivos multifunción. Los logotipos y las normas de Energy Star son idénticos en todo el mundo.

Esta máquina dispone de los siguientes modos de ahorro de energía: modo Apagado panel, modo Ahorro energía y modo Apagado auto. La máquina sale del modo de ahorro de energía cuando recibe un trabajo de impresión o cuando se pulsa una tecla. Para obtener más información sobre cómo configurar los modos de ahorro de energía, consulte en el Manual de software en formato HTML presente en el CD-ROM.

❖ **Modo Apagado panel**

La máquina espera, de forma predeterminada, 10 segundos antes de pasar al modo Apagado panel. Sin embargo, es posible modificar este tiempo.

❖ **Modo Ahorro energía (modo de bajo consumo)**

Si la máquina permanece inactiva durante un determinado tiempo, reduce automáticamente su consumo eléctrico.

La máquina espera, de forma predeterminada, 1 minuto antes de pasar al modo Ahorro energía. Sin embargo, es posible modificar este tiempo.

❖ **Modo Apagado auto (modo suspensión)**

Si la máquina ya está en modo de bajo consumo y permanece inactiva durante un período determinado, pasa automáticamente al modo de suspensión para reducir el consumo de energía.

La máquina espera, de forma predeterminada, 11 minutos antes de pasar al modo Apagado auto. Sin embargo, es posible modificar este tiempo.

La máquina puede imprimir trabajos de impresión de ordenadores en el modo de suspensión.

❖ Características técnicas

Modo Apagado panel	Consumo	150 W o menos
	Tiempo predeterminado	10 segundos
	Tiempo de recuperación	10 segundos
Modo Ahorro energía (Modo bajo consumo)	Consumo	110 W o menos
	Tiempo predeterminado	1 minuto
	Tiempo de recuperación	Tipo 1: 24 segundos o menos Tipo 2: 26 segundos o menos
Modo Apagado auto (Modo suspensión)	Consumo	6 W o menos
	Tiempo predeterminado	11 minutos
	Tiempo de recuperación	Tipo 1: 47 segundos o menos Tipo 2: 50 segundos o menos

Papel reciclado

Recomendamos utilizar papel reciclado, ya que es más respetuoso con el medio ambiente. Póngase en contacto con su comercial para obtener información sobre el papel recomendado.

Informação

Introdução

Este manual contém instruções detalhadas e notas para a operação e manutenção deste equipamento. Para a sua própria segurança e benefício, leia este manual cuidadosamente antes de utilizar o equipamento. Mantenha este manual num local à mão para que possa ser rapidamente consultado.

Importante

Os conteúdos deste manual estão sujeitos a alterações sem aviso prévio.

Em nenhuma circunstância, a empresa será responsável por danos directos, indirectos, especiais, acidentais ou consequentes, resultantes do manuseamento ou da operação do equipamento.



Notas:

Algumas imagens neste manual podem ser ligeiramente diferentes do equipamento.

Algumas opções podem não estar disponíveis em alguns países. Para mais detalhes, contacte o seu fornecedor local.

Dependendo do país em que se encontra, algumas unidades podem ser opcionais. Para mais detalhes, contacte o seu fornecedor local.



Cuidado

Para obter uma boa qualidade de impressão, o fabricante recomenda a utilização de toner genuíno do fabricante.

O fabricante não será responsável por qualquer dano ou despesa que possa resultar da utilização de peças nos seus produtos para escritório, que não sejam peças genuínas do fabricante.

Notas

Os nomes de modelo dos equipamentos não aparecem nas seguintes páginas. Verifique o tipo do seu equipamento antes de ler o manual. (Para mais informações, consulte o Guia de Hardware no CD-ROM.)

- Tipo 1: CLP37DN/SP C430DN/LP137CN/Aficio SP C430DN
- Tipo 2: CLP42DN/SP C431DN/LP142CN/Aficio SP C431DN

Alguns tipos podem não estar disponíveis em alguns países. Para mais detalhes, contacte o seu fornecedor local.

Neste manual são utilizadas duas unidades de medição. Para este equipamento use a versão métrica.

Fonte de alimentação

120 - 127 V, 50/60 Hz, 12 A ou mais

Certifique-se de que liga o cabo de alimentação a uma fonte de alimentação com as características descritas acima.

Leis e regulamentações

Proibição legal

Não copie nem imprima qualquer item cuja reprodução seja proibida por lei. A cópia ou impressão dos itens apresentados a seguir é geralmente proibida por lei:

notas monetárias, selos fiscais, obrigações, acções, cheques bancários, cheques, passaportes, cartas de condução.

A lista anterior serve apenas como referência e não é extensiva. Não nos responsabilizamos pela sua abrangência ou exactidão. Se tiver alguma questão relativamente à legalidade de cópia ou impressão de determinados itens, consulte o seu conselheiro legal.

Segurança laser

Regulamentações CDRH

Este equipamento está em conformidade com os requisitos de 21 CFR, sub-capítulo J para produtos de laser classe 1.

Este equipamento contém um díodo laser AlGaInP, de 15 miliwatts, com comprimento de onda de 657 - 663 nanómetros.

Este equipamento não emite luz perigosa, uma vez que o feixe está totalmente vedado durante todos os modos de operação e manutenção do cliente.

Cuidado:

A utilização de controlos ou de ajustes ou a realização de procedimentos, além dos especificados neste manual, pode resultar numa exposição a radiação perigosa.

Normas FCC e Normas IC

Aviso:

Este dispositivo está em conformidade com a parte 15 das Normas FCC e RSS-Gen das Normas IC.

O funcionamento está sujeito às seguintes duas condições:

1. Este dispositivo não pode causar interferências nocivas e
2. Este dispositivo tem de aceitar quaisquer interferências recebidas, incluindo interferências que possam causar um funcionamento indesejado.

As alterações ou modificações não expressamente aprovadas pela parte responsável pela conformidade poderão anular a autoridade do utilizador para usar este equipamento.

Este dispositivo não pode ser co-localizado ou utilizado em conjunto com qualquer outra antena ou transmissor, excepto para o módulo Wireless LAN RWL54MN (FCC ID: BBP-WLRWL541) que foi objecto de teste de co-localização.

Nota para os utilizadores nos Estados Unidos da América

Normas FCC

❖ Declaração de Conformidade

Este dispositivo está em conformidade com a Parte 15 das Normas FCC.

O funcionamento está sujeito às seguintes duas condições:

- (1) Este dispositivo não pode causar interferências nocivas e
- (2) este dispositivo tem de aceitar quaisquer interferências recebidas, incluindo interferências que possam causar um funcionamento indesejado.

Parte responsável: Ricoh Americas Corporation.

Endereço: 5 Dedrick Place, West Caldwell, NJ 07006

Número de telefone: 973-882-2000

Nome do Produto: Impressora a Laser

Número do modelo: CLP37DN/SP C430DN/LP137CN/Aficio SP C430DN
CLP42DN/SP C431DN/LP142CN/Aficio SP C431DN

❖ Nota

Este equipamento foi testado e está em conformidade com os limites para um dispositivo digital de Classe B, de acordo com a Parte 15 das Normas FCC. Estes limites foram concebidos para oferecer uma protecção razoável contra interferências nocivas numa instalação residencial. Este equipamento gera, utiliza e pode irradiar energia de frequências rádio e, se não for instalado e utilizado de acordo com as instruções, pode causar interferências nocivas em comunicações rádio. No entanto, não é dada garantia que não ocorrerão interferências numa instalação em particular. Se este equipamento causar interferências nocivas em recepção de rádio ou televisão, o que pode ser determinado desligando e voltando a ligar o equipamento, recomenda-se que o utilizador experimente corrigir as interferências através de uma ou mais das seguintes medidas:

- Reorientar ou mudar a posição da antena receptora.
- Aumentar a distância entre o equipamento e o receptor.
- Ligue o equipamento a uma tomada num circuito diferente daquele a que está ligado o receptor.
- Consulte o seu representante ou um técnico experiente de rádio/TV para obter ajuda.

❖ Cuidado

As alterações ou modificações não expressamente aprovadas pela parte responsável pela conformidade poderão anular a autoridade do utilizador para usar este equipamento.

Notas sobre a(s) lâmpada(s) no interior do equipamento

LAMP(S) INSIDE THIS PRODUCT CONTAIN MERCURY AND MUST BE RECYCLED OR DISPOSED OF ACCORDING TO LOCAL, STATE OR FEDERAL LAWS.

Notas para os utilizadores do estado da Califórnia

Material de Perclorato - pode aplicar-se um tratamento especial, Consulte www.dtsc.ca.gov/hazardouswaste/perchlorate

Nota para os utilizadores do Canadá

Nota

Este aparelho digital de Classe B está em conformidade com a Norma Canadina ICES- 003.

Remarque concernant les utilisateurs au Canada

Avertissement

Cet appareil numérique de la classe B est conforme à la norme NMB-003 du Canada.

Informações de Segurança

Quando usar este equipamento, deve tomar sempre as precauções de segurança apresentadas em seguida.

Segurança durante a operação

Neste manual, são utilizados os seguintes símbolos importantes:

⚠ AVISO:

Indica uma situação de risco potencial que, se não forem seguidas as instruções, pode resultar em ferimentos graves ou morte.

⚠ CUIDADO:

Indica uma situação de risco potencial que, se não forem seguidas as instruções, pode resultar em danos materiais ou ferimentos menores.

Precauções de Segurança a Seguir

Esta secção explica precauções de segurança que devem ser sempre seguidas quando utilizar este equipamento.

Ambientes em que o equipamento pode ser utilizado

Esta secção explica precauções de segurança relativas a ambientes em que o equipamento pode ser utilizado.

⚠ AVISO:

- ***Não utilize sprays ou solventes inflamáveis perto do equipamento. Se o fizer, pode provocar um incêndio ou choque eléctrico.***

- ***Não coloque jarras, vasos, copos, produtos de higiene pessoal, medicamentos, pequenos objectos de metal ou recipientes com água ou outros líquidos em cima do equipamento ou na sua proximidade. Existe o risco de incêndio ou choque eléctrico se estes objectos ou substâncias caírem para dentro do equipamento.***

⚠ CUIDADO:

- ***Mantenha o equipamento protegido da humidade e poeira. Caso contrário, pode ocorrer um incêndio ou um choque eléctrico.***

- ***Não coloque o equipamento numa superfície inclinada ou instável. Se tombar, pode provocar ferimentos.***

- Não coloque objectos pesados sobre o equipamento. Se o fizer, o equipamento pode tombar, podendo provocar ferimentos.
- Certifique-se de que utiliza o equipamento numa área espaçosa e bem ventilada. Uma boa ventilação é especialmente importante quando o equipamento é utilizado com muita frequência.
- Não tape as saídas de ventilação do equipamento. Se o fizer, existe o risco de incêndio causado pelo sobreaquecimento dos componentes internos.
- Quando novos, os dispositivos eléctricos com materiais voláteis libertam normalmente emissões para o ar circundante. Por isso, durante os primeiros dias após a instalação de um dispositivo novo, é necessário assegurar uma boa ventilação no espaço em que o equipamento for instalado.
- Os níveis sonoros do equipamento que excedem LWAd > 63 dB (A) não são adequados para ambientes de trabalho de escritório; por este motivo, o equipamento noutra local.
- É necessário utilizar a mesa de apoio se pretender utilizar a impressora colocada no chão, com a unidade de alimentação de papel opcional instalada. A não utilização da mesa de apoio pode provocar ferimentos nos utilizadores e danos na impressora se tombar. A mesa de apoio apenas pode ser instalada por um técnico de assistência. Contacte a assistência técnica para obter mais informações.

Nota

- Para evitar a possível acumulação de ozono, coloque este equipamento numa sala bem ventilada com uma circulação de ar superior a 30 m³/hr/pessoa.

Manuseamento de cabos e fichas de alimentação

Esta secção explica precauções de segurança sobre o manuseamento de cabos e fichas de alimentação.

AVISO:

- **Se o cabo de alimentação ficar danificado e os fios interiores ficarem expostos ou partidos, contacte a assistência técnica para proceder à sua substituição. A utilização de cabos de alimentação danificados pode resultar num incêndio ou choque eléctrico.**
- **Não utilize quaisquer fontes de alimentação que não as correspondentes às especificações indicadas neste manual. Se o fizer, pode provocar um incêndio ou choque eléctrico.**

• **Não utilize quaisquer outras frequências que não as correspondentes às especificações abaixo indicadas. Se o fizer, pode provocar um incêndio ou choque eléctrico.**

• **Não utilize adaptadores multi-tomada. Se o fizer, pode provocar um incêndio ou choque eléctrico.**

• **Não utilize cabos de extensão. Se o fizer, pode provocar um incêndio ou choque eléctrico.**

• **Não utilize cabos de alimentação danificados, partidos ou modificados. Para além disso, não utilize cabos de alimentação que tenham ficado presos debaixo de objectos pesados, que tenham sido puxados com demasiada força ou muito dobrados. Se o fizer, pode provocar um incêndio ou choque eléctrico.**

• **Tocar nos pinos da ficha do cabo de alimentação com objectos metálicos constitui um risco de incêndio e de choque eléctrico.**

• **O cabo de alimentação fornecido destina-se apenas a uma utilização com este equipamento. Não o utilize com outros aparelhos. Se o fizer, pode provocar um incêndio ou choque eléctrico.**

• **É perigoso tocar na ficha do cabo de alimentação com as mãos húmidas. Se o fizer, pode provocar um choque eléctrico.**

⚠ CUIDADO:

• **Certifique-se de que insere na totalidade a ficha do cabo de alimentação na tomada de parede. As fichas parcialmente introduzidas resultam numa ligação instável, que pode provocar uma acumulação de calor perigosa.**

• **Se este equipamento não for utilizado durante um longo período, desligue o cabo de alimentação da tomada de parede.**

• **Quando desligar o cabo de alimentação da tomada de parede, puxe sempre pela ficha, não pelo cabo. Puxar o cabo pode danificar o cabo de alimentação. A utilização de cabos de alimentação danificados pode resultar num incêndio ou choque eléctrico.**

• **Certifique-se de que desliga a ficha da tomada de parede e que limpa os pinos e a área envolvente pelo menos uma vez por ano. A acumulação de pó na ficha representa um risco de incêndio.**

• **Quando proceder à manutenção do equipamento, desligue sempre o cabo de alimentação da tomada.**

Manuseamento do equipamento principal

Esta secção explica as precauções de segurança relativas ao manuseamento do equipamento principal.

AVISO:

- ***Certifique-se de que instala o equipamento tão próximo quanto possível de uma tomada de parede. Isto permitirá desligar facilmente o cabo de alimentação em caso de emergência.***
- ***Se o equipamento emitir fumo ou odores, ou se apresentar um comportamento anómalo, desligue imediatamente a alimentação pressionando o interruptor de alimentação. Após desligar a alimentação, certifique-se de que desliga a ficha do cabo de alimentação da tomada de parede. Em seguida, contacte o seu representante da assistência técnica e comunique o problema. Não utilize o equipamento. Se o fizer, pode provocar um incêndio ou choque eléctrico.***
- ***Se objectos metálicos, água ou outros fluidos caírem para dentro do equipamento, desligue imediatamente a alimentação através do interruptor de alimentação. Após desligar a alimentação, certifique-se de que desliga a ficha do cabo de alimentação da tomada de parede. Em seguida, contacte o seu representante de vendas ou da assistência técnica e comunique o problema. Não utilize o equipamento. Se o fizer, pode provocar um incêndio ou choque eléctrico.***
- ***Se o equipamento tombar, ou se uma tampa ou outra peça ficar danificada, desligue o interruptor de alimentação e desligue a ficha do cabo de alimentação da tomada de parede. Em seguida, contacte o seu representante da assistência técnica e comunique o problema. Não utilize o equipamento. Se o fizer, pode provocar um incêndio ou choque eléctrico.***
- ***Não toque neste equipamento se cair um raio nas proximidades. Se o fizer, pode provocar um choque eléctrico.***
- ***Mantenha todos os materiais em polietileno (sacos, etc.) fornecidos com este equipamento sempre fora do alcance de bebés e crianças pequenas. Se os materiais em polietileno entrarem em contacto com a boca ou o nariz, tal pode provocar asfixia.***

CUIDADO:

- ***Desligue o cabo de alimentação da tomada de parede antes de mover o equipamento. Ao mover o equipamento, tenha cuidado para que o cabo de alimentação não fique danificado debaixo do equipamento. A não observância destas precauções pode provocar um incêndio ou choque eléctrico.***

• *Antes de instalar ou remover opções, retire sempre os cabos de alimentação da tomada de parede e deixe a unidade principal arrefecer durante algum tempo. A não observância destas precauções pode provocar queimaduras.*

• *Por motivos ambientais, não coloque o equipamento ou os desperdícios nos pontos de recolha de resíduos domésticos. A deposição pode ser efectuada num fornecedor autorizado.*

• *Quando deslocar o equipamento, segure pelas pegas de ambos os lados e levante a impressora lentamente. Se a levantar sem cuidado ou a deixar cair, pode provocar ferimentos.*

⚠ Importante

- Tensão nominal do conector para opções: Máx. CC 24 V.
- A tensão não deve oscilar mais de 10%.

Manuseamento do interior do equipamento

Esta secção explica as precauções de segurança relativas ao manuseamento do interior do equipamento.

⚠ AVISO:

- ***Não retire quaisquer tampas ou parafusos que não os explicitamente indicados neste manual. No interior do equipamento existem componentes de alta tensão que constituem um risco de choque eléctrico e componentes laser que podem provocar a perda de visão. Contacte o seu representante de vendas ou da assistência técnica se algum dos componentes internos do equipamento necessitar de manutenção, ajuste ou reparação.***
- ***Não tente desmontar ou modificar o equipamento. Fazê-lo constitui um risco de queimaduras e de choque eléctrico. É importante lembrar que a exposição aos componentes laser no interior do equipamento pode provocar a perda de visão.***

⚠ CUIDADO:

- *Alguns dos componentes internos do equipamento atingem elevadas temperaturas. Por esse motivo, proceda com cuidado quando retirar papel encravado. Se não tiver cuidado, pode sofrer queimaduras.*
- *A secção de fusão deste equipamento pode estar muito quente. Deve ter muito cuidado para não tocar nesta parte quando remover papel encravado.*
- *O interior do equipamento pode estar muito quente. Não toque nas peças com uma etiqueta a indicar uma "superfície quente". Caso contrário, pode sofrer ferimentos.*
- *Quando colocar papel, proceda com cuidado para não trilhar ou ferir os dedos.*
- *Durante o funcionamento, os rolos de transporte do papel e originais rodam. Foi instalado um dispositivo de segurança para que o equipamento possa ser utilizado em segurança. De qualquer modo, tenha o cuidado de não mexer no equipamento durante o funcionamento. Caso contrário, pode sofrer ferimentos.*
- *Se o interior do equipamento não for limpo com regularidade, ocorrerá acumulação de pó. A forte acumulação de pó dentro do equipamento constitui risco de incêndio e avaria. Consulte o representante de vendas ou da assistência técnica para obter mais informações sobre a limpeza do interior do equipamento e respectivos custos.*
- *Não puxe a bandeja de papel com demasiada força. Se o fizer, a bandeja pode cair e provocar ferimentos.*
- *Não toque no interior do compartimento da placa controladora. Pode provocar uma avaria do equipamento ou sofrer queimaduras.*
- *Existe o risco de explosão se a bateria for substituída com um tipo incorrecto. Proceda à deposição de baterias usadas de acordo com as instruções.*

Manuseamento dos consumíveis do equipamento

Esta secção explica as precauções de segurança relativas ao manuseamento dos consumíveis do equipamento.

⚠ AVISO:

- ***Não incinere o toner (novo ou usado) ou os recipientes do toner. Fazê-lo representa um risco de queimadura. O toner incendeia-se em contacto com chamas.***
- ***Não guarde o toner (novo ou usado) ou os recipientes do toner próximo de uma chama. Fazê-lo representa um risco de incêndio e de queimadura. O toner incendeia-se em contacto com chamas.***
- ***Mantenha todos os materiais em polietileno (sacos, luvas, etc.) fornecidos com este equipamento sempre fora do alcance de bebês e crianças pequenas. Se os materiais em polietileno entrarem em contacto com a boca ou o nariz, tal pode provocar asfixia.***

⚠ CUIDADO:

- *Não esmague nem aperte os recipientes de toner. Se o fizer, pode causar um derramamento de toner, podendo sujar a pele, a roupa e o chão, e resultar na sua ingestão acidental.*
- *Guarde o toner (usado ou não usado) e os recipientes de toner fora do alcance das crianças.*
- *Se inalar toner ou toner usado, gargareje com muita água e desloque-se para um local arejado. Consulte um médico, se necessário.*
- *Se entrar toner ou toner usado nos olhos, lave-os imediata e abundantemente com água. Consulte um médico, se necessário.*
- *Se engolir toner ou toner usado, beba uma grande quantidade de água para o diluir. Consulte um médico, se necessário.*
- *Quando remover o papel encravado ou substituir toner, evite derramar toner (novo ou usado) na sua roupa. Se o toner entrar em contacto com a sua roupa, lave a área manchada com água fria. A água quente fixa o toner no tecido e pode tornar impossível remover a mancha.*
- *Quando remover o papel encravado ou substituir toner, evite derramar toner (novo ou usado) na sua pele. Se a pele entrar em contacto com o toner, lave a área afectada com água e sabão.*
- *Não utilize qualquer outro tipo de papel condutor. Fazê-lo representa um risco de incêndio.*

Etiquetas de Segurança deste Equipamento

Esta secção explica as etiquetas de informação de segurança do equipamento.

Posições das etiquetas ⚠AVISO e ⚠CUIDADO

Este equipamento tem etiquetas para ⚠AVISO e ⚠CUIDADO nas posições abaixo indicadas. Por motivos de segurança, cumpra as instruções e manuseie o equipamento como indicado.

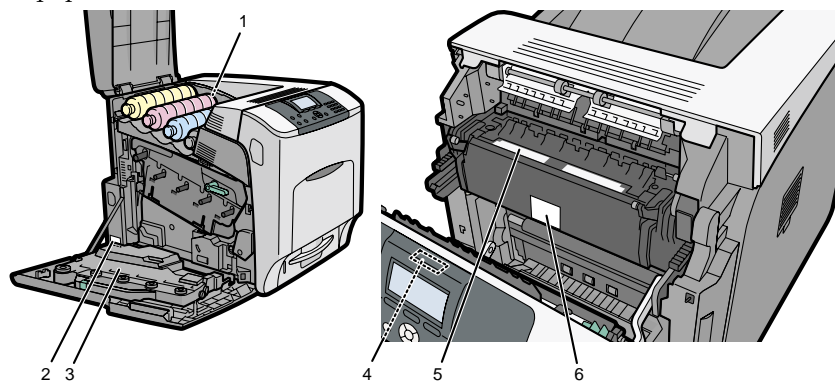

1



Não incinere toner usado ou derramado. O pó do toner é inflamável e pode incendiar-se quando exposto a uma chama.

A deposição deve ser realizada junto de um representante autorizado ou num local de recolha adequado.

Se optar por proceder à deposição dos recipientes de toner, faça-o de acordo com a regulamentação local.

2

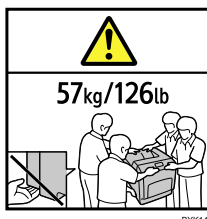

A impressora pesa aproximadamente 57 kg (126 lb.).

São necessárias quatro pessoas para deslocar a impressora. Segure pelas pegas de ambos os lados e levante-a lentamente. Se levantar sem cuidado ou a deixar cair, pode provocar ferimentos.

3



Não incinere o toner usado ou os recipientes do toner. O pó do toner pode inflamar-se quando exposto a uma chama.

4



Algumas peças do rolo de transferência podem estar carregadas com tensão elevada e representar um risco de choque eléctrico. Não toque noutras peças que não as especificadas no guia de manutenção.

5

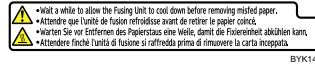
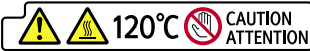

Peças de temperatura elevada. Desligue a alimentação principal e proceda com cuidado quando substituir a unidade de fusão/remover papel encravado.

6

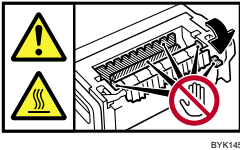

O interior da impressora atinge temperaturas muito elevadas. Não toque nas peças com a etiqueta “△” (indica uma superfície quente). Tocar nestas peças pode resultar em queimaduras.

Símbolos do Interruptor de Alimentação

Os significados dos símbolos para os interruptores do equipamento são os seguintes:

- | :LIGADO.
- ○ :DESLIGADO.
- ⏻ :EM ESPERA.

Programa ENERGY STAR

Requisitos para Equipamentos de Processamento de Imagem do Programa ENERGY STAR®



Os requisitos para equipamentos de processamento de imagem do Programa ENERGY STAR® encorajam a poupança de energia através da promoção de computadores e outros equipamentos de escritório eficientes em termos energéticos.

Este programa apoia o desenvolvimento e divulgação de produtos com funções de poupança de energia.

É um programa aberto, no qual os fabricantes participam voluntariamente.

Os produtos-alvo são computadores, monitores, impressoras, faxes, copiadores, scanners e equipamentos multifuncionais. As normas e logótipos Energy Star são internacionalmente uniformes.

Este equipamento está equipado com os seguintes modos de Poupança de Energia: Modo Pannel Desligado, Modo Poupança de Energia e Modo Desligar Automático. Este equipamento sai do modo de Poupança de Energia quando recebe um trabalho de impressão ou quando é premeida uma tecla. Para mais informações sobre a configuração dos modos de Poupança de Energia, consulte o Guia de Software, disponibilizado em ficheiro HTML no CD-ROM.

❖ **Modo Pannel Desligado**

O período predefinido que o equipamento aguarda antes de entrar no Modo Pannel Desligado é de 10 segundos. O tempo predefinido pode ser alterado.

❖ **Modo Poupança de Energia (Modo Baixo Consumo)**

Se o equipamento permanecer inactivo durante um determinado tempo, o consumo eléctrico é automaticamente reduzido.

O período predefinido que o equipamento aguarda antes de entrar no Modo Poupança de Energia é de 1 minuto. O tempo predefinido pode ser alterado.

❖ **Modo Desligar Automático (Modo de Suspensão)**

Se este equipamento já se encontrar no modo de Baixo Consumo e permanecer inactivo durante um período especificado, entra automaticamente no modo de Suspensão para reduzir ainda mais o consumo eléctrico.

O período predefinido que o equipamento aguarda antes de entrar no Modo Desligar Automático é de 11 minutos. O tempo predefinido pode ser alterado.

Este equipamento imprime trabalhos enviados a partir de computadores enquanto se encontra no modo de Suspensão.

❖ Especificações técnicas

Modo Painel Desligado	Consumo de energia	150 W ou menos
	Tempo predefinido	10 segundos
	Tempo de recuperação	10 segundos
Modo Poupança de Energia (Modo Baixo Consumo)	Consumo de energia	110 W ou menos
	Tempo predefinido	1 minuto
	Tempo de recuperação	Tipo 1: 24 segundos ou menos Tipo 2: 26 segundos ou menos
Modo Desligar Automático (Modo de Suspensão)	Consumo de energia	6 W ou menos
	Tempo predefinido	11 minutos
	Tempo de recuperação	Tipo 1: 47 segundos ou menos Tipo 2: 50 segundos ou menos

Papel reciclado

Recomendamos a utilização de papel reciclado por ser amigo do ambiente. Contacte o seu consultor comercial para informações sobre o papel recomendado.





Operating Instructions Hardware Guide

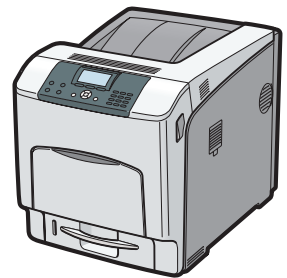

-
- 1** Guide to the Printer
 - 2** Setting Up the Printer
 - 3** Installing Options
 - 4** Connecting the Printer
 - 5** Configuration
 - 6** Paper and Other Media
 - 7** Maintaining the Printer
 - 8** Adjusting the Printer
 - 9** Troubleshooting
 - 10** Removing Misfed Paper
 - 11** Appendix

Introduction

This manual contains detailed instructions and notes on the operation and use of this machine. For your safety and benefit, read this manual carefully before using the machine. Keep this manual in a handy place for quick reference.

Do not copy or print any item for which reproduction is prohibited by law.

Copying or printing the following items is generally prohibited by local law:

bank notes, revenue stamps, bonds, stock certificates, bank drafts, checks, passports, driver's licenses.

The preceding list is meant as a guide only and is not inclusive. We assume no responsibility for its completeness or accuracy. If you have any questions concerning the legality of copying or printing certain items, consult with your legal advisor.

Important

Contents of this manual are subject to change without prior notice.

In no event will the company be liable for direct, indirect, special, incidental, or consequential damages as a result of handling or operating the machine.

For good print quality, the manufacturer recommends that you use genuine toner from the manufacturer.

The manufacturer shall not be responsible for any damage or expense that might result from the use of parts other than genuine parts from the manufacturer with your office products.

Some illustrations in this manual might be slightly different from the machine.

Certain options might not be available in some countries. For details, please contact your local dealer.

TABLE OF CONTENTS

How to Read This Manual.....	6
Symbols.....	6
Model-Specific Information.....	7
Machine Types.....	7
Positions of WARNING and CAUTION Labels.....	9
Power Switch Symbols.....	10
Manuals for This Printer.....	11
List of Options.....	13
Installing the Operating Instructions.....	14
Installing the HTML Format Manuals.....	14
Opening the HTML Format Manuals.....	15

1. Guide to the Printer

Exterior: Front View.....	17
Exterior: Rear View.....	19
Interior.....	21
Control Panel.....	23
Display Panel.....	25
Entering Character.....	26
How to Enter Characters.....	27

2. Setting Up the Printer

Printer Set Up Procedure.....	31
Place to Install.....	32
Checking the Contents of the Box.....	36
Removing the Packaging Materials.....	38
Installing the Toner (Print Cartridge).....	43
Loading Paper.....	47
Turning the Printer's Power On and Off.....	50
Turning on the Power.....	50
Turning off the Power.....	51
Selecting the Display Language.....	54
Test Printing.....	55
Installing the ELP-NX Card.....	56

3. Installing Options

Available Options.....	59
Order of Option Installation.....	59
Where to Install Options.....	60
Cautions When Re-installing the Controller Board.....	62
Attaching the Paper Feed Unit.....	63
Installing the Memory Expansion Units.....	67
Installing the SDRAM Module.....	67
Installing the Hard Disk.....	70
Installing the Interface Units.....	75
Installing the Gigabit Ethernet Board.....	75
Installing the Wireless LAN Interface Board.....	77
Installing the IEEE 1284 Interface Board.....	79
Installing the SD Memory Card Options.....	82

4. Connecting the Printer

Ethernet Cable Connection.....	85
Reading the LED Lamps.....	87
USB Cable Connection.....	89
Digital Camera Connection.....	90
Parallel Cable Connection.....	92

5. Configuration

Ethernet Configuration.....	93
Specifying an IP Address (No DHCP).....	94
Receiving an IP Address Automatically (DHCP).....	96
Configuring Network Settings When Using NetWare.....	98
Setting the Ethernet Speed.....	99
Enabling IEEE802.1X Authentication.....	101
Wireless LAN Configuration.....	104
Setting the SSID.....	106
Confirming Wireless Network Connectivity.....	107
Cautions When Using a Wireless LAN.....	108
Setting Security Method of Wireless LAN.....	109
Setting a WEP Key.....	109

Setting WPA.....	110
Configuring IEEE 802.1X.....	115
Installing a Site Certificate.....	115
Installing Device Certificate.....	115
Setting Items of WPA/WPA2.....	117

6. Paper and Other Media

Supported Paper for Each Tray.....	119
Symbols.....	119
Standard Paper Feed Tray and optional paper feed trays.....	119
Bypass Tray.....	121
Paper Weight and Capacity.....	122
Paper Recommendations.....	123
Storing Paper.....	123
Types of Paper and Other Media.....	123
Paper Not Supported by This Printer.....	135
Print Area.....	136
Loading Paper.....	138
Loading Paper into Standard Paper Feed Tray or Optional Paper Feed Trays.....	138
Loading Paper in Bypass Tray.....	146
Loading Envelopes.....	152
Switching between Paper Trays.....	157
Printing on Orientation-Fixed or Two-Sided Paper.....	158
Using Paper Types that Have Unique Names.....	159
From Registration of User Paper Types to Use.....	159
Registering Names to Paper Types.....	160
Setting User Paper Types to Trays.....	161
Printing Using Registered Paper Types.....	161

7. Maintaining the Printer

Adding Toner (Print Cartridge).....	163
Replacing the Drum Unit.....	168
Replacing the Transfer Unit and Transfer Roller.....	170
Replacing the Waste Toner Bottle.....	172
Replacing the Fusing Unit and Dustproof Filters.....	174

Cautions When Cleaning.....	176
Cleaning the Paper Feed Roller.....	177
Cleaning the Registration Roller.....	180

8. Adjusting the Printer

Adjusting the Color Registration.....	183
Correcting the Color Gradation.....	185
Setting the Gradation Correction Value.....	185
Viewing the Color Calibration Sample Sheet and Gradation Correction Sheet.....	188
Resetting the Gradation Correction Value to the Initial Value.....	190
Adjusting Printing Position.....	192
Adjusting the Paper Type.....	195

9. Troubleshooting

Error and Status Messages Appear on the Control Panel.....	197
Panel Tones.....	203
Printer Does Not Print.....	204
Checking the Port Connection.....	205
Other Printing Problems.....	207
When You Cannot Print Properly.....	207
Paper Misfeeds Occur Frequently.....	209
The printed image is different from the image on the computer.....	210
When Printer is Not Functioning Properly.....	212
Additional Troubleshooting.....	215

10. Removing Misfed Paper

Removing Misfed Paper.....	217
Paper Misfeed Message (A).....	218
Paper Misfeed Message (B) (C).....	219
Paper Misfeed Message (Y).....	222
Paper Misfeed Message (Z).....	224

11. Appendix

Moving and Transporting the Printer.....	227
Moving the Printer a Short Distance.....	228
Consumables.....	230
Toner (Print Cartridge).....	230

Waste Toner Bottle.....	230
Drum Unit.....	230
Transfer Unit.....	231
Fusing Unit.....	231
Specifications.....	232
Mainframe.....	232
Options.....	235
INDEX	239

How to Read This Manual

Symbols

This manual uses the following symbols:

 **Important**

Indicates points to pay attention to when using the machine, and explanations of likely causes of paper misfeeds, damage to originals, or loss of data. Be sure to read these explanations.

 **Note**

Indicates supplementary explanations of the machine's functions, and instructions on resolving user errors.

 **Reference**

This symbol is located at the end of sections. It indicates where you can find further relevant information.

[]

Indicates the names of keys on the machine's display or control panels.

 **Region A** (mainly Europe and Asia)

 **Region B** (mainly North America)

Differences in the functions of Region A and Region B models are indicated by two symbols. Read the information indicated by the symbol that corresponds to the region of the model you are using. For details about which symbol corresponds to the model you are using, see "Model-Specific Information".

Model-Specific Information

This section explains how you can identify the region your machine belongs to.

There is a label on the rear of the machine, located in the position shown below. The label contains details that identify the region your machine belongs to. Read the label.

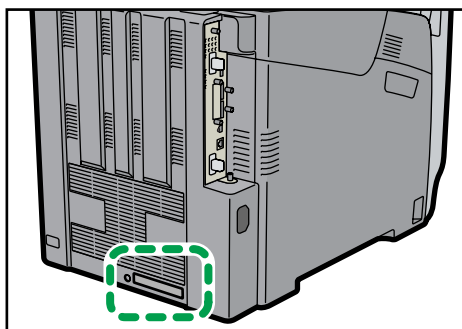

BYK003

The following information is region-specific. Read the information under the symbol that corresponds to the region of your machine.

 **Region A** (mainly Europe and Asia)

If the label contains the following, your machine is a region A model:

- CODE XXXX -22, -27
- 220-240V

 **Region B** (mainly North America)

If the label contains the following, your machine is a region B model:

- CODE XXXX -11, -17
- 120-127V

Note

- Dimensions in this manual are given in two units of measure: metric and inch. If your machine is a Region A model, refer to the metric units. If your machine is a Region B model, refer to the inch units.

Machine Types

This printer comes in two models that have different printing speeds.

When describing procedures that are model-specific, this manual refers to the different printer models as Type 1 or Type 2. The following table describes the model types.

Model types

Model types	Printing Speed	Hard Disk
Type 1	maximum 35 pages per minute (A4 [□])	Optional
Type 2	maximum 40 pages per minute (A4 [□])	Standard

Positions of WARNING and CAUTION Labels

This printer has labels for ⚠WARNING and ⚠CAUTION at the positions shown below. For safety, please follow the instructions and handle the printer as indicated.

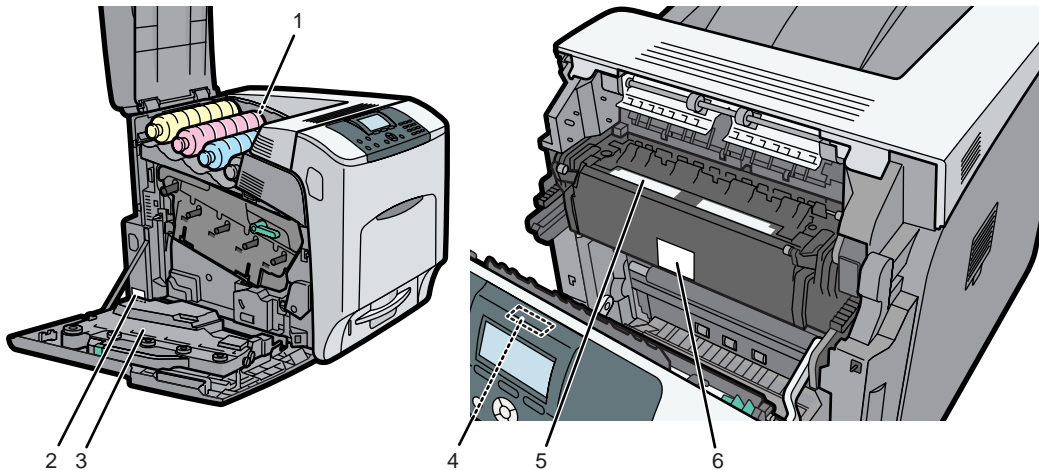

BYK001

1



BYK140

Do not incinerate spilled toner or used toner. Toner dust is flammable and might ignite when exposed to an open flame.

Disposal should take place at an authorized dealer or an appropriate collection site.

If you dispose of the used toner containers yourself, dispose of them according to local regulations.

2



BYK144

The printer weights approximately 57 kg (126 lb.).

Four people are required to move the printer. Hold the inset grips located on both sides, and then lift it slowly. Lifting it carelessly or dropping it may cause an injury.

3



BYK202

Do not incinerate used toner or toner containers. Toner dust might ignite when exposed to an open flame.

4



BYK147

Some parts of the Transfer roller may be charged with high voltage, and pose electric shock hazard. Do not touch parts other than the ones specified in the maintenance guide.

5



BYK146

High temperature parts, Turn off the main power and be careful when replacing fusing unit/removing misfed paper.

6

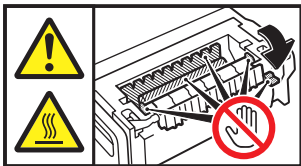

BYK145

The inside of this printer becomes very hot. Do not touch parts labelled "△" (indicating a hot surface). Touching these parts will result in burns.

Power Switch Symbols

- I: POWER ON.
- O: POWER OFF.
- ⏻: STANDBY.

Manuals for This Printer

Read this manual carefully before you use this printer.

Refer to the manuals that are relevant to what you want to do with the printer.

Important

- Media differ according to manual.
- The printed and electronic versions of a manual have the same contents.
- Adobe Acrobat Reader/Adobe Reader must be installed in order to view the manuals as PDF files.
- A Web browser must be installed in order to view the html manuals.

Safety Information

Contains information about safe usage of this printer.

To avoid injury and prevent damage to the printer, be sure to read this.

Quick Installation Guide

Contains procedures for removing the printer from its box, and connecting it to a computer.

Hardware Guide (This manual)

Contains information about paper and procedures such as installing options, replacing consumables, responding to error messages, and resolving jams.

Driver Installation Guide

Contains procedures for installing the printer driver. This manual is included on the driver CD-ROM.

Software Guide

Contains information about using this printer, its software, and its security functions.

Security Guide

This manual is for administrators of the printer. It explains security functions that you can use to prevent unauthorized use of the printer, data tampering, or information leakage. Be sure to read this manual when setting the enhanced security functions, or user and administrator authentication.

Enhanced Locked Print NX User's Guide (Type 2 model only)

This manual is for ordinary users (non-administrators) of Enhanced Locked Print NX. It explains the procedures for configuring authentication using the printer driver, and logging on to Enhanced Locked Print NX to print or delete jobs.

Enhanced Locked Print NX Administrator's Guide (Type 2 model only)

This manual is for administrators of Enhanced Locked Print NX. It explains the procedures for using the management tool to configure system and option settings, and manage print jobs.

This manual is provided in English only.

VM Card Extended Feature Settings Web Reference

Contains information about setting up the extended features settings using Web Image Monitor.

UNIX Supplement

Contains information about the usage of commands to operate this printer.

To obtain the "UNIX Supplement", visit our Web site or consult an authorized dealer.

This manual includes explanations of functions and settings that might not be available on this printer.



This manual is provided in English only.

Note

- Manuals provided are specific to printer types.

List of Options

This section provides a list of options for this printer, and how they are referred to as in this manual.

Option List	Referred to as
Paper Feed Unit PB1020	Paper feed unit
Caster Table Type C	Tip-resistant caster table
Hard Disk Drive Option Type 5000	Hard disk
Memory Unit Type G 256 MB	SDRAM module
Memory Unit Type I 512 MB	SDRAM module
Gigabit Ethernet Board Type A	Gigabit Ethernet board
 Region B IEEE 802.11a/g Interface Unit Type L	Wireless LAN interface unit
 Region A IEEE 802.11a/g Interface Unit Type M	Wireless LAN interface unit
IEEE 1284 Interface Board Type A	IEEE 1284 interface board
Camera Direct Print Card Type H	Camera direct print card
Data Overwrite Security Unit Type K	Data overwrite security unit
HDD Encryption Unit Type D	HDD encryption unit
SD card for NetWare printing Type D	NetWare card
VM Card Type O	VM card

Note

- For details about the specifications of each option, see "Specifications".

Reference

- p.232 "Specifications"

Installing the Operating Instructions

This section explains how to use HTML format manuals.

Installing the HTML Format Manuals

The supplied "Manuals" CD-ROMs contain HTML format manuals. For easy access, we recommend you install the manuals on a computer.

★ Important

- **The system requirements for installing the manuals are as follows:**
 - **Minimum display resolution: 800 × 600 pixels**
- **Recommended browsers:**
 - **Microsoft Internet Explorer 4.01 SP2 or later**
- **Non-recommended browsers can display the simplified manual only.**
- **If you are using a Macintosh, click [Read HTML manuals] to view manuals.**

- 1. Quit all applications currently running.**
- 2. Insert the CD-ROM into the CD-ROM drive.**

The installer starts.

Auto Run may not work with certain operating system settings. If this happens, launch "Setup.exe" on the CD-ROM root directory.

- 3. Select a language and a product, and then click [OK].**
- 4. Click [Install manuals].**

If you want to read manuals from the CD-ROM, click [Read HTML manuals].
- 5. Install the manual you require according to the displayed instructions.**
- 6. When installation is complete, click [Finish].**
- 7. Click [Finish].**

↓ Note

- Depending on the printer model, PDF manuals may be supplied in the CD-ROM. To open PDF manuals, click [Read PDF manuals] in step 2.
- If you cannot install a manual, copy the "MANUAL_HTML" folder to your computer's hard drive, and then run "Setup.exe".
- To delete an installed manual, on the [Start] menu, point to [All Programs], then [Product Name], and then click [Uninstall]. Follow the instructions to delete the manual.

Opening the HTML Format Manuals

This section explains how to open the HTML format manuals.

Opening from the Icon

This section explains how to open a manual using its desktop icon.

1. **Double-click the icon on your desktop.**



The browser opens and the manual appears.

Opening from the [Start] Menu

This section explains how to open a manual from the [Start] menu.

1. **On the [Start] menu, point to [All Programs] (for operating systems other than Windows XP: [Programs]), then [Product Name], and then click the manual you want to view.**

The browser opens, and then the manual appears.

↓ Note

- Depending on the settings made during installation, menu folder names may differ.

Opening from the CD-ROM

This section explains how to open a manual from the supplied “Manuals” CD-ROM.

1. **Click [Read HTML manuals].**
2. **Click the title of the manual you want to view.**

The browser opens, and then the manual appears.



1. Guide to the Printer

This chapter explains the names and functions of the printer's components.

Exterior: Front View

This section introduces the names and functions of the parts on the front and right sides of the printer.

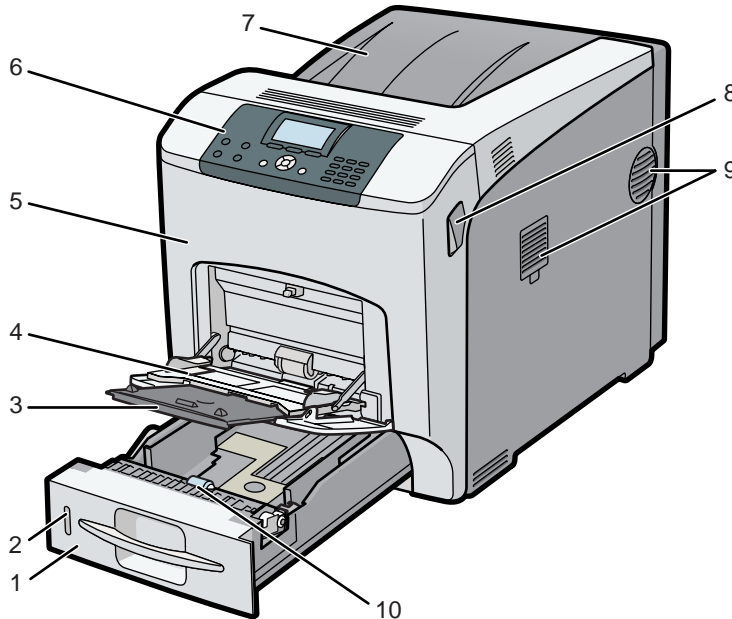

BYK004

1. Standard Paper Feed Tray (Tray 1)

Up to 550 sheets of plain paper can be loaded.

2. The Remaining Paper Indicator

Indicates the approximate amount of paper remaining in the tray.

3. Bypass Tray Extension

Pull this out when loading a sheet that is larger than A5 on the bypass tray.

4. Bypass Tray

Up to 100 sheets of plain paper can be loaded.

5. Front Cover

Open the front cover to replace the fusing unit or transfer roller, or to remove jammed paper.

6. Control Panel

Contains keys for printer control and a display that shows the printer status.

7. Standard Tray / Top Cover

Under normal operation, output is stacked on the top cover, which works as the standard output tray. Open this cover to replace the toner.

8. Front Cover Open Levers

Pull these levers toward the front side of the printer to open the front cover.

9. Vents

The right side of the printer features two vents. To prevent overheating, heat from internal components is released through these vents. Malfunctions and failure can result if these vents are blocked or obstructed.

The dustproof filter needs to be replaced regularly for proper maintenance.

Replace the dustproof filter when the following message appears:

- "Replcmnt Rqrd:Fusing Unit"

Replace the dustproof filter and the fusing unit together.

10. Paper Feed Roller

This ensures only one sheet of paper is fed in at a time. If multi-sheet feeds occur, clean the paper feed roller carefully.

↓ Note

- For details about the messages which appear on the screen to prompt you to replace the units, see "Error and Status Messages Appears on the Control Panel".

📖 Reference

- p.197 "Error and Status Messages Appear on the Control Panel"

Exterior: Rear View

This section introduces the names and functions of the parts on the rear side of the printer.

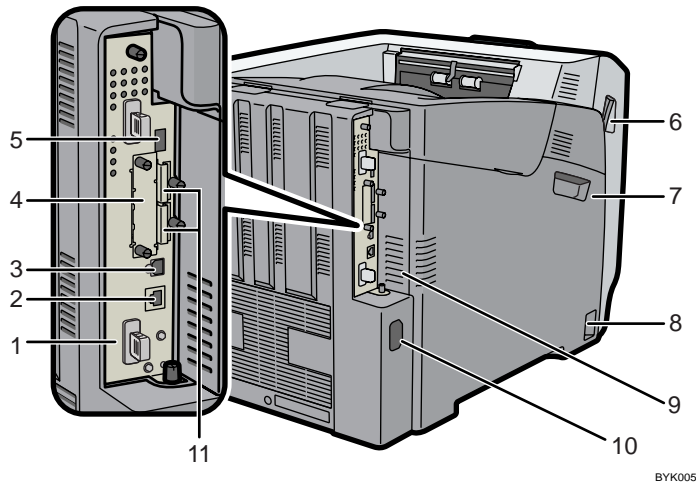

1. Controller Board

Slide this out to install options such as the memory unit or printer hard disk. Plug cables such as a USB cable and Ethernet cable into their connectors.

2. Ethernet Port

Use a network interface cable to connect the printer to a network.

3. USB Port B

Use a USB cable to connect the printer to a computer.

4. Optional Interface Board Slot

Insert an optional Wireless LAN interface unit, Gigabit Ethernet board, or 1284 interface board in this slot.

5. USB Port A

Use a USB cable to connect the printer to a digital camera.

6. Front Cover Open Levers

Pull these levers toward the front side of the printer to open the front cover.

7. Left Cover

Open this cover when replacing the drum unit, transfer unit or waste toner bottle.

8. Power Switch

Use this switch to turn the power on and off.

9. Vents

To prevent overheating, heat from internal components is released through these vents. Malfunctions and failure can result if these vents are blocked or obstructed.

The dustproof filter needs to be replaced regularly for proper maintenance.

Replace the dustproof filter when the following message appears:

- "Replcmnt Rqrd:Fusing Unit"

Replace the dustproof filter and the fusing unit together.

1

10. Power Connector

Connect the power cord to the printer here. Insert the other end of the cable into a nearby wall outlet.

11. SD Card Slots

Remove the cover and install SD cards here. Install the data overwrite security unit, NetWare card or camera direct print card in the upper slot. Install the VM card or HDD encryption unit in the lower slot.

↓ Note

- For details about the messages which appear on the screen to prompt you to replace the units, see "Error and Status Messages Appears on the Control Panel".

📖 Reference

- p.197 "Error and Status Messages Appear on the Control Panel"

Interior

This section introduces the names and functions of the parts inside of the printer.

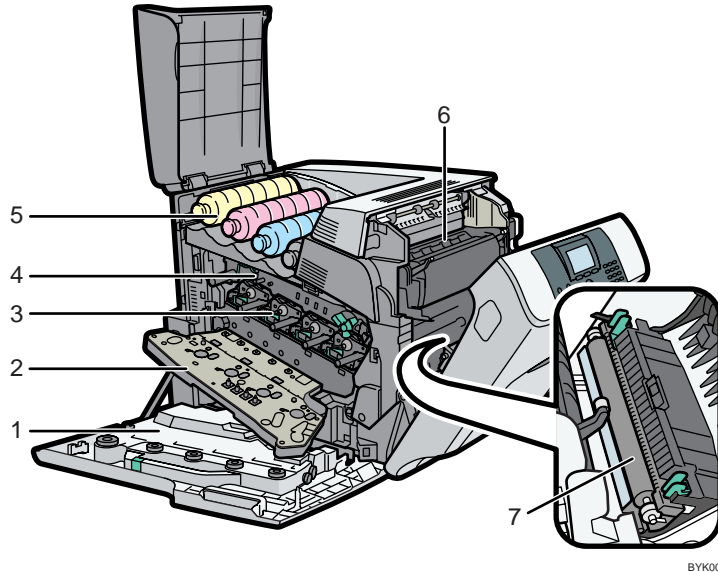

BYK006

1. Waste Toner Bottle

Collects toner that is wasted during printing.

If the message which prompts you to replace it appears on the display, replace the waste toner bottle.

- "🗑️ Waste Toner Bottle full"

2. Inner Cover

Open this cover when replacing the drum unit or transfer unit.

3. Drum Unit

From the left, the drum units are installed in the order of yellow (Y), magenta (M), cyan (C), and black (K). Replace the relevant drum unit when the following messages appear:

- "Rplcmnt Requird:PCU:Black"
- "Rplcmnt Requird:PCU:Color"

4. Transfer Unit

Replace the transfer unit when the following message appears:

- "Replacmnt Requird:IntTrans"

Replace the transfer unit and transfer roller together.

5. Toner

From the left, the toner is installed in the order of yellow (Y), magenta (M), cyan (C), and black (K). Replace the relevant toner when the following message appears:

- "🖨️ Add toner<K,C,M,Y>."

6. Fusing Unit

Replace the fusing unit when the following message appears:

- "Replcmnt Rqrd:Fusing Unit"

Replace the fusing unit and the dustproof filter together.

7. Transfer Roller

Replace the transfer roller when the following message appears:

- "Replacmnt Requrd:IntTrans"

Replace the transfer roller and the transfer unit together.

Note

- For details about the messages which appear on the screen to prompt you to replace the units, see "Error and Status Messages Appears on the Control Panel".

Reference

- p.197 "Error and Status Messages Appear on the Control Panel"

Control Panel

This section explains names and usage of the parts of the control panel.

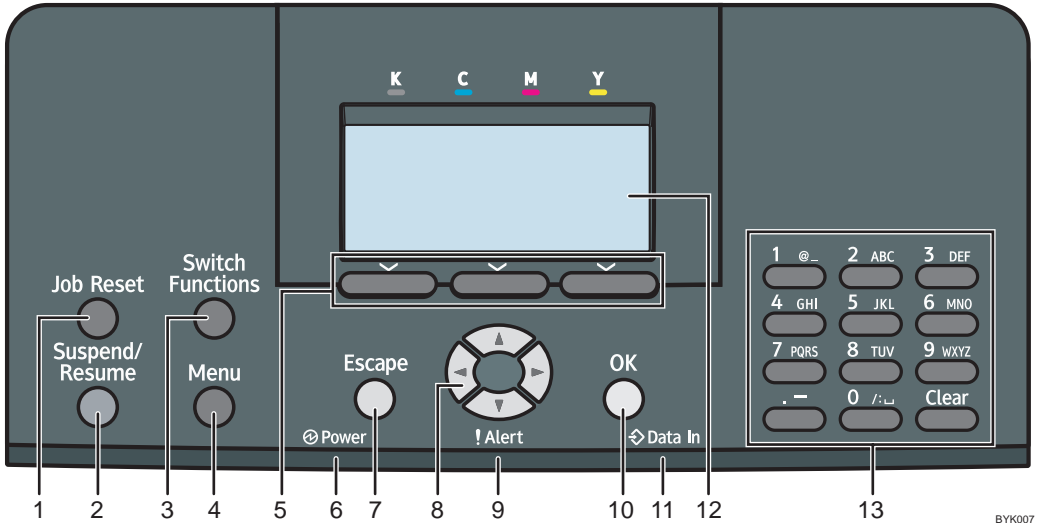

1. [Job Reset] Key

When the printer is online, press this key to cancel an ongoing print job.

2. [Suspend/Resume] Key

Press this to suspend a print job. This key remains lit as long as the job is suspended. To resume the job, press this key again.

3. [Switch Functions] Key

Press this key to switch between the operation screen of the printer function and the function screens of the extended features currently in use.

4. [Menu] Key

Press this key to configure and check the current printer settings.

5. Selection Keys

Correspond to the function items at the bottom line on the display.

Example: When this manual instructs you to press [Option], press the selection key on the left below the initial screen.

6. Power Indicator

Lights up when the printer is ready to receive data from a computer. Flashes when the printer is warming up or receiving data. It is unlit when the power is off or while the printer is in energy saver mode.

7. [Escape] Key

Press this key to return to the previous display.

8. Scroll Keys

Press these keys to move the cursor in each direction.

When the [▲] [▼] [◀] [▶] keys appear in this manual, press the scroll key of the same direction.

9. Alert Indicator

Lights up or flashes when a printer error occurs.

Steady red: printing is not possible, or is possible but print quality cannot be ensured.

Flashing yellow: the printer will soon require maintenance or a replacement consumable such as toner.

Follow the instructions that appear on the display.

10. [OK] Key

Use this key to confirm settings, or setting values, or move to the next menu level.

11. Data In Indicator

Flashes when the printer is receiving data from a computer. The data in indicator is lit if there is data to be printed.

12. Display

Displays current printer status and error messages.

Entering energy saver mode turns off the back light. For details about energy saver mode, see Software Guide.

13. Number Keys

Use these to enter characters or numbers.

Display Panel

This section explains configuration using the initial screen of the display panel.

The items are highlighted when selected.

★ Important

- Do not touch the display panel.

The following screen appears when you turn on the printer.

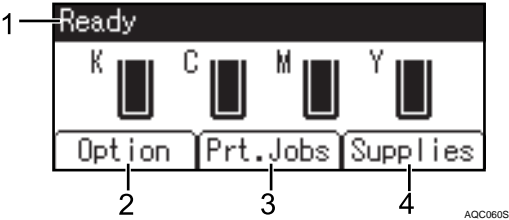

1. Operational Status or Messages

Displays the printer status or the messages.

2. [Option]

Press to display the following items:

- Form Feed
- Error Log

3. [Prt.Jobs]

Press to display print jobs sent from a computer.

4. [Supplies]

Press to display the menu of supplies for the printer.

↓ Note

- [Prt.Jobs] is displayed only when the hard disk is installed in the printer.
- By default, the remaining amount of toner is displayed. To not display the remaining amount of toner, press the [Menu] key, and then select [Maintenance] on the display. Select [General Settings], then [Display Supply Info], and then select [Off].
- Adjust the brightness if the screen is dark. To adjust the display contrast, press the [Menu] key, and then select [Maintenance] on the display. Select [General Settings] and then [Display Contrast].

Entering Character

This section explains how to enter characters.

When you enter a character, it appears at the position of the cursor. If there is a character already at the cursor position, the entered character appears before that.

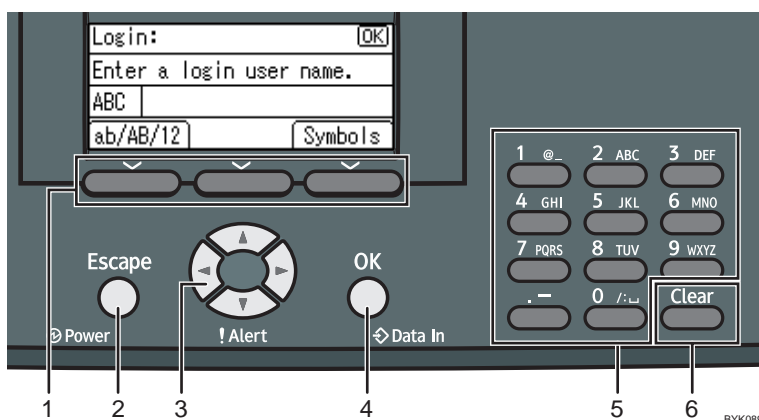

1. Selection Keys

Correspond to the function items on the bottom line of the display.

Example: When this manual instructs you to press [ab/AB/12], press the selection key on the left below the text input screen.

Press the left selection key to switch the input mode between lowercase, uppercase, and numeric characters.

Press the right selection key to display a list of the symbols that you can enter.

2. [Escape] Key

Clears entered text and numbers, returns the display to its previous state.

3. Scroll Keys

Press to move the cursor in each direction.

When the [▲] [▼] [◀] [▶] keys appear in this manual, press the scroll key of the same direction.

4. [OK] Key

Confirms entered text and numbers, and displays to the next menu.

5. Number Keys

To enter text using the number keys, select text input mode by pressing [ab/AB/12].

When you press a number key repeatedly, the character changes in the order indicated above the key you are pressing.

6. [Clear] Key

Deletes a character at the cursor position. You can delete a character at the right end of a line even if the cursor is placed to the right of the character.

How to Enter Characters

Use the following procedure to enter text in the text input screen. ("User#2" is the text entered in this example.)

1. Press [ab/AB/12] to change the input mode to uppercase.

Login:	[OK]
Enter a login user name.	
ABC	
ab/AB/12	Symbols

2. Press the [8 TUV] key twice, and then press the [►] key. A letter "U" is entered.

Login:	[OK]
Enter a login user name.	
ABC	U_
ab/AB/12	Symbols

3. Press [ab/AB/12] twice to change the input mode to lowercase.

Login:	[OK]
Enter a login user name.	
abc	U_
ab/AB/12	Symbols

4. Press the [7 PQRS] key four times, and then press the [►] key. A letter "s" is entered.

Login:	[OK]
Enter a login user name.	
abc	Us_
ab/AB/12	Symbols

5. Press the [3 DEF] key twice, and then press the [►] key. A letter "e" is entered.

Login:	[OK]
Enter a login user name.	
abc	Use_
ab/AB/12	Symbols

6. Press the [7 PQRS] key three times, and then press the [►] key. A letter "r" is entered.

Login:	[OK]
Enter a login user name.	
abc User_	
ab/AB/12	Symbols

7. Press [Symbols] to display a list of the symbols you can enter.

Login:	[OK]
Enter a login user name.	
abc User_	
ab/AB/12	Symbols

Symbols:	1/2	[OK]
! " # \$ % & ' ()		
* + , - . / : ; <		
= > ? @ [\] ^ _		

8. Use the scroll keys to select "#", and then press the [OK] key.

Symbols:	1/2	[OK]
! " # \$ % & ' ()		
* + , - . / : ; <		
= > ? @ [\] ^ _		

The list of symbols disappears and a "#" symbol is entered.

Login:	[OK]
Enter a login user name.	
abc User#_	
ab/AB/12	Symbols

9. Press [ab/AB/12] twice to change the input mode to numeric.

Login:	[OK]
Enter a login user name.	
123 User#	
ab/AB/12	Symbols

10. Press the [2 ABC] key. A number "2" is entered.

Login:	[OK]
Enter a login user name.	
123	User#2_
ab/AB/12	Symbols

11. Press the [OK] key to proceed to the next menu.

2. Setting Up the Printer

This chapter explains how to set up and configure the printer for operation.

Printer Set Up Procedure

Use the following procedure to set up the printer.

2

- 1. Select a suitable location for your printer.**
For details, see p.32 "Place to Install".
- 2. Verify the items that come with the printer.**
For details, see p.36 "Checking the Contents of the Box".
- 3. Take the printer out of its box, and then remove the protective materials and adhesive tape.**
For details, see p.38 "Removing the Packaging Materials".
- 4. Install the toner (print cartridge) in the printer.**
For details, see p.43 "Installing the Toner (Print Cartridge)".
- 5. Load paper in the standard paper feed tray.**
For details, see p.47 "Loading Paper".
- 6. Turn the printer power on.**
For details, see p.50 "Turning the Printer's Power On and Off".
- 7. Select the language used on the display.**
For details, see p.54 "Selecting the Display Language".
- 8. Print a test page.**
For details, see p.55 "Test Printing".
- 9. Connect the printer to your network.**
For details, see p.85 "Connecting the Printer".
- 10. Configure the printer's network settings.**
For details, see p.93 "Configuration".
- 11. If you are using a Type 2 model, install the ELP-NX card.**
For details, see p.56 "Installing the ELP-NX Card".
- 12. Install the printer driver.**
For details, see Driver Installation Guide.

Place to Install

The printer's location should be carefully chosen because environmental conditions greatly affect its performance.

WARNING

- Do not use any power sources other than those that match the specifications shown. Doing so could result in fire or electric shock.

WARNING

- Do not use any frequencies other than those that match the specifications shown. Doing so could result in fire or electric shock.

WARNING

- Do not use any power sources other than those that match the specifications shown in "Safety Information". Doing so could result in fire or electric shock.

WARNING

- Do not use multi-socket adaptors. Doing so could result in fire or electric shock.

WARNING

- Do not use extension cords. Doing so could result in fire or electric shock.

WARNING

- Do not use power cords that are damaged, broken, or modified. Also, do not use power cords that have been trapped under heavy objects, pulled hard, or bent severely. Doing so could result in fire or electric shock.

WARNING

- Touching the prongs of the power cable's plug with anything metallic constitutes a fire and electric shock hazard.

WARNING

- The supplied power cord is for use with this machine only. Do not use it with other appliances. Doing so could result in fire or electric shock.

⚠ WARNING

- It is dangerous to handle the power cord plug with wet hands. Doing so could result in electric shock.

⚠ WARNING

- If the power cord is damaged and its inner wires are exposed or broken, contact your service representative for a replacement. Use of damaged power cords could result in fire or electric shock.

⚠ WARNING

- Be sure to locate the machine as close as possible to a wall outlet. This will allow easy disconnection of the power cord in the event of an emergency.

⚠ WARNING

- Do not use flammable sprays or solvents in the vicinity of this machine. Doing so could result in fire or electric shock.

⚠ CAUTION

- Keep the machine away from humidity and dust. Otherwise a fire or an electric shock might occur.

⚠ CAUTION

- Do not place the machine on an unstable or tilted surface. If it topples over, an injury might occur.

⚠ CAUTION

- Make sure the room where you are using the machine is well ventilated and spacious. Good ventilation is especially important when the machine is used heavily.

Space Required for Installation

The recommended (or minimum) space requirements are as follows:

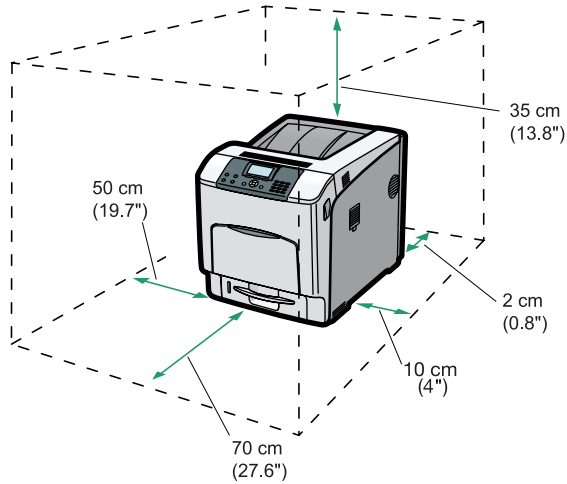

BYK011

Optimum Environmental Conditions

Permissible and recommended temperature and humidity ranges are as follows:

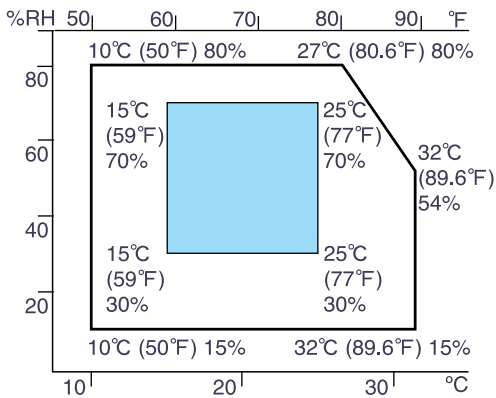

BSP023S

- White area: Permissible Range
- Blue area: Recommended Range

Note

- The machine must be level within 5 mm, 0.2" from both front to rear and left to right.
- To avoid possible build-up of ozone, locate this machine in large well ventilated room that has an air turnover of more than 30 m³/ hr/ person.
- When you use this machine for a long time in a confined space without good ventilation, you may detect an odd smell. To keep the workplace comfortable, we recommend you keep it well ventilated.

Environments to Avoid

Do not use the printer in the following environments:

★ Important

- Areas exposed to direct sunlight or strong light
- Dusty areas
- Areas with corrosive gases
- Areas that are excessively cold, hot, or humid
- Areas directly exposed to currents of hot, cold, or room-temperature air from air conditioners
- Areas directly exposed to radiant heat from heaters
- Locations near air conditioners, heaters, or humidifiers
- Locations near other electronic equipment
- Locations subject to frequent strong vibration

Power Source

Connect the power cord to a power source of the following specification:

 **Region A** (mainly Europe and Asia)
220 - 240 V, 50/ 60 Hz, 8 A or more

 **Region B** (mainly North America)
120 - 127 V, 60 Hz, 12 A or more

Checking the Contents of the Box

Follow the procedure below to verify the items that come with the printer.

★ Important

- Ensure that the box contains all items listed below. If there are any missing or defective items, contact your sales representative.

Manuals and CD-ROMs

- Quick Installation Guide
- CD-ROM "Printer Drivers"
- CD-ROM "Manuals"
- Power Cord

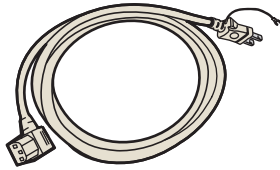

BYK154

- Ferrite Core

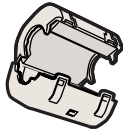

BYK012

- Toner: Black (K), Cyan (C), Magenta (M), Yellow (Y)

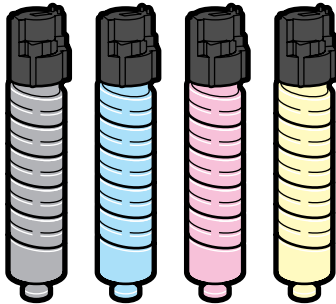

BYK013

- ELP-NX Card (Type 2 model only)

• Paper Feed Unit Labels

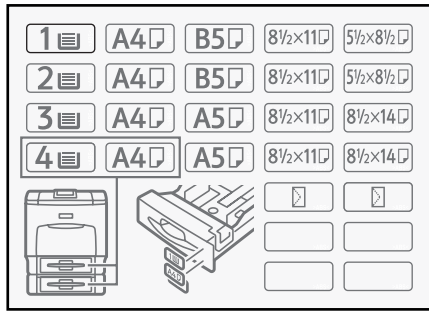

BYK019

• Color Calibration Sample Sheet

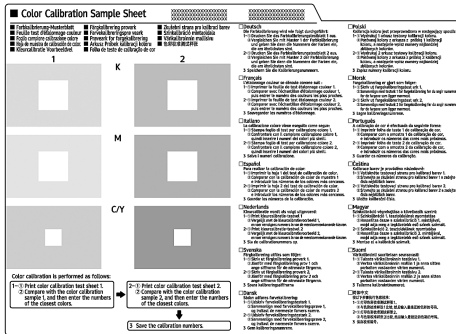

• Paper Weight/Grade Chart

Region B (mainly North America)

Notes for Users

Attach this seal to a clearly visible part of the machine so that users can select the appropriate machine setting mode according to paper type.

Mode Setting Instructions

For optimal print quality, select the appropriate Paper Type and Setting Mode on the printer's Control Panel using the following instructions:

- Press the [Menu] key, select [Maintenance], [General Settings], and then select a paper type.
- Select mode according to the chart below. The greater number corresponds to thicker settings.
- Refer to the manual for further details.

Paper Type	Setting Mode
Letterhead	1 • 2* • 3 • 4 • 5
Coated Paper (Glossy)	1 • 2 • 3 • 4* • 5
Coated Paper (Glossy) Thick	1* • 2
Coated Paper (Matte)	1 • 2 • 3 • 4* • 5
Control Paper (Matte) Thick	1* • 2
Waterproof Paper	1 • 2 • 3 • 4 • 5*
Label Paper	1 • 2 • 3 • 4 • 5 • 6*
Envelope	1* • 2 • 3 • 4

* Default Setting

Paper Weight/Grade Chart

Paper Type	Weight	Paper Grade			
	g/m ²	Bond	Cover	Bristol	Index Book
Thin Paper	52~	161	191	261	291
Plain 1	61~	16	23	28	34
Plain 2	81~	22	30	37	45
Medium Thick	91~	26	34	41	50
Thick 1	106~	28	39	48	59
Thick 2	131~	31	46	60	72
Thick 3	164~	44	61	75	91
Thick 4	221~	59	82	101	122
	~256	68	95	117	142

BYK120

• Additional Documentation

Note

- This package does not include an interface cable. Purchase one as necessary to connect to the printer.

37

Removing the Packaging Materials

To protect it from shock and vibration during transit, this printer comes packaged in cushioning foam and secured with tape. Remove these protective materials after bringing the machine to where it will be installed.

⚠ WARNING

- Keep the polythene materials (bags, etc.) supplied with this machine away from babies and small children at all times. Suffocation can result if polythene materials are brought into contact with the mouth or nose.

⚠ CAUTION

- When lifting the machine, use the inset grips on both sides. The printer could break or cause an injury if dropped.

⚠ CAUTION

- Place no objects on the left or inner cover.

★ Important

- Removed tape is dirty. Be careful not to let it touch your hands or clothes.

1. Remove the plastic bag.
2. Lift the printer with four people by using the inset grips on both sides of the printer.

Leave the tape holding the paper feed tray and cover in place while moving the printer. Lower the machine slowly and carefully to prevent trapping your hands.

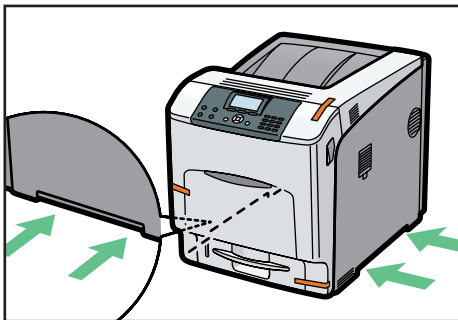

BYK014

When moving the printer, do not hold on the following parts as doing so could cause a malfunction:

- The handle onto the standard paper feed tray.
- The underside of the bypass tray.
- The underside of the box containing the controller board (on the back of the printer).

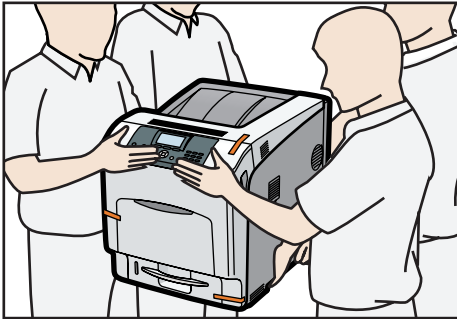

BYK165

3. Remove the orange adhesive tape from the printer body.

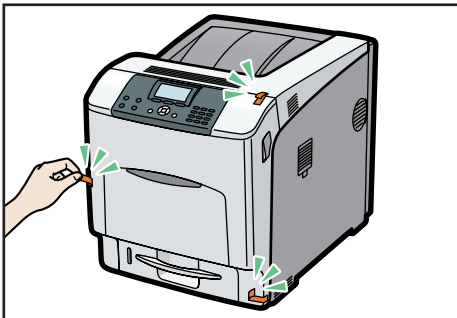

BYK150

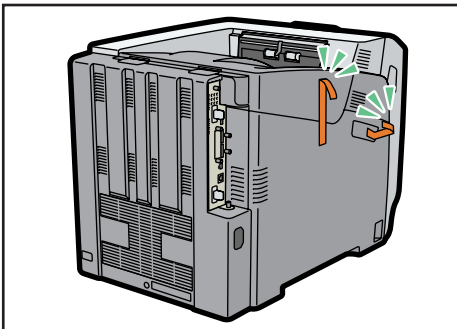

BYK151

4. Carefully open the left cover.

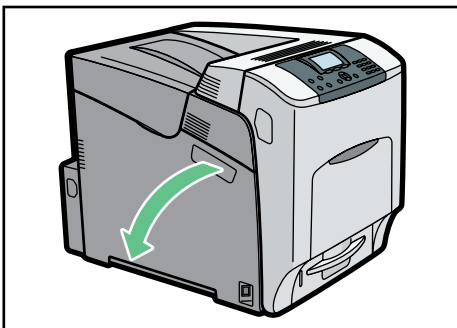

BYK016

5. Turn the green lever counterclockwise (①), and then slowly open the inner cover (②).

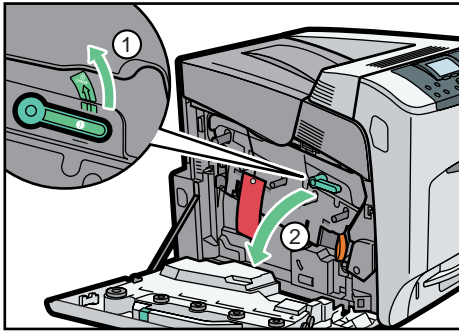

BYK017

6. Remove the securing pin, as shown, from the transfer unit. Pinch it (①), and then pull it out (②-③).

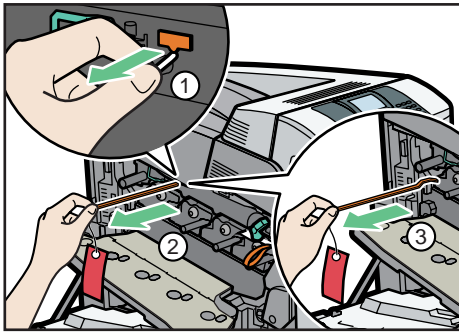

BYK020

7. Turn the green lever of the transfer unit counterclockwise to unlock the unit (①). Remove the protective sheet, as shown. Pinch the orange tape (②), and then pull it out (③).

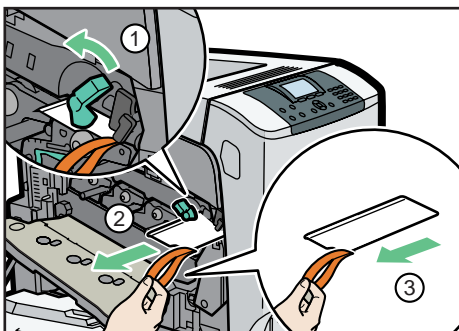

BYK021

- Turn the green lever clockwise to lock the unit.

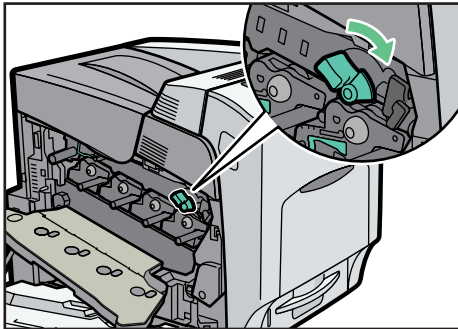

BYK023

- Close the inner cover.

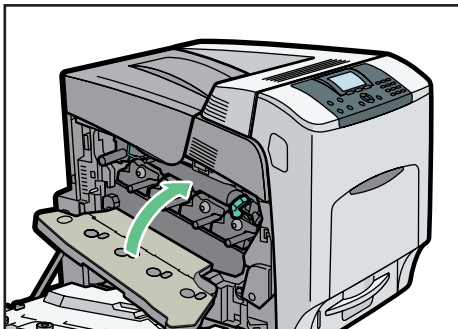

BYK024

- Lock the inner cover by pushing on both ends (①), and then turning the green lever clockwise (②).

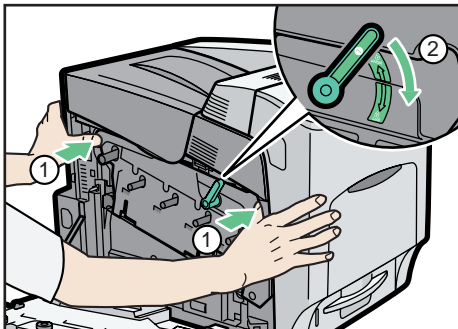

BYK141

- Close the left cover.

Using both hands, push the left cover firmly, until it clicks into place.

2

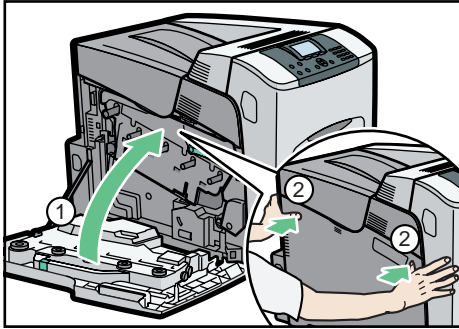

BYK149

12. Put labels "1" on the front of the paper tray.

Mode Setting Instructions
 For optimal print quality, select the appropriate Paper Type and Setting Mode on the printer. Confirm Paper using the following instructions:
 • Press the Home key, select [Paperweight], [General Settings], and then select a paper type.
 • Refer to the manual for further details.
 *The greater number corresponds to thicker settings.

Paper	Weight	Paper Type
A4	75g	Standard
A4	90g	Standard
A4	105g	Standard
A4	120g	Standard
A4	150g	Standard
A4	180g	Standard
A4	200g	Standard
A4	240g	Standard
A4	280g	Standard
A4	300g	Standard
A4	350g	Standard
A4	400g	Standard
A4	450g	Standard
A4	500g	Standard
A4	550g	Standard
A4	600g	Standard
A4	650g	Standard
A4	700g	Standard
A4	750g	Standard
A4	800g	Standard
A4	850g	Standard
A4	900g	Standard
A4	950g	Standard
A4	1000g	Standard
A4	1100g	Standard
A4	1200g	Standard
A4	1300g	Standard
A4	1400g	Standard
A4	1500g	Standard
A4	1600g	Standard
A4	1700g	Standard
A4	1800g	Standard
A4	1900g	Standard
A4	2000g	Standard
A4	2100g	Standard
A4	2200g	Standard
A4	2300g	Standard
A4	2400g	Standard
A4	2500g	Standard
A4	2600g	Standard
A4	2700g	Standard
A4	2800g	Standard
A4	2900g	Standard
A4	3000g	Standard
A4	3100g	Standard
A4	3200g	Standard
A4	3300g	Standard
A4	3400g	Standard
A4	3500g	Standard
A4	3600g	Standard
A4	3700g	Standard
A4	3800g	Standard
A4	3900g	Standard
A4	4000g	Standard
A4	4100g	Standard
A4	4200g	Standard
A4	4300g	Standard
A4	4400g	Standard
A4	4500g	Standard
A4	4600g	Standard
A4	4700g	Standard
A4	4800g	Standard
A4	4900g	Standard
A4	5000g	Standard
A4	5100g	Standard
A4	5200g	Standard
A4	5300g	Standard
A4	5400g	Standard
A4	5500g	Standard
A4	5600g	Standard
A4	5700g	Standard
A4	5800g	Standard
A4	5900g	Standard
A4	6000g	Standard
A4	6100g	Standard
A4	6200g	Standard
A4	6300g	Standard
A4	6400g	Standard
A4	6500g	Standard
A4	6600g	Standard
A4	6700g	Standard
A4	6800g	Standard
A4	6900g	Standard
A4	7000g	Standard
A4	7100g	Standard
A4	7200g	Standard
A4	7300g	Standard
A4	7400g	Standard
A4	7500g	Standard
A4	7600g	Standard
A4	7700g	Standard
A4	7800g	Standard
A4	7900g	Standard
A4	8000g	Standard
A4	8100g	Standard
A4	8200g	Standard
A4	8300g	Standard
A4	8400g	Standard
A4	8500g	Standard
A4	8600g	Standard
A4	8700g	Standard
A4	8800g	Standard
A4	8900g	Standard
A4	9000g	Standard
A4	9100g	Standard
A4	9200g	Standard
A4	9300g	Standard
A4	9400g	Standard
A4	9500g	Standard
A4	9600g	Standard
A4	9700g	Standard
A4	9800g	Standard
A4	9900g	Standard
A4	10000g	Standard
A4	10100g	Standard
A4	10200g	Standard
A4	10300g	Standard
A4	10400g	Standard
A4	10500g	Standard
A4	10600g	Standard
A4	10700g	Standard
A4	10800g	Standard
A4	10900g	Standard
A4	11000g	Standard
A4	11100g	Standard
A4	11200g	Standard
A4	11300g	Standard
A4	11400g	Standard
A4	11500g	Standard
A4	11600g	Standard
A4	11700g	Standard
A4	11800g	Standard
A4	11900g	Standard
A4	12000g	Standard
A4	12100g	Standard
A4	12200g	Standard
A4	12300g	Standard
A4	12400g	Standard
A4	12500g	Standard
A4	12600g	Standard
A4	12700g	Standard
A4	12800g	Standard
A4	12900g	Standard
A4	13000g	Standard
A4	13100g	Standard
A4	13200g	Standard
A4	13300g	Standard
A4	13400g	Standard
A4	13500g	Standard
A4	13600g	Standard
A4	13700g	Standard
A4	13800g	Standard
A4	13900g	Standard
A4	14000g	Standard
A4	14100g	Standard
A4	14200g	Standard
A4	14300g	Standard
A4	14400g	Standard
A4	14500g	Standard
A4	14600g	Standard
A4	14700g	Standard
A4	14800g	Standard
A4	14900g	Standard
A4	15000g	Standard
A4	15100g	Standard
A4	15200g	Standard
A4	15300g	Standard
A4	15400g	Standard
A4	15500g	Standard
A4	15600g	Standard
A4	15700g	Standard
A4	15800g	Standard
A4	15900g	Standard
A4	16000g	Standard
A4	16100g	Standard
A4	16200g	Standard
A4	16300g	Standard
A4	16400g	Standard
A4	16500g	Standard
A4	16600g	Standard
A4	16700g	Standard
A4	16800g	Standard
A4	16900g	Standard
A4	17000g	Standard
A4	17100g	Standard
A4	17200g	Standard
A4	17300g	Standard
A4	17400g	Standard
A4	17500g	Standard
A4	17600g	Standard
A4	17700g	Standard
A4	17800g	Standard
A4	17900g	Standard
A4	18000g	Standard
A4	18100g	Standard
A4	18200g	Standard
A4	18300g	Standard
A4	18400g	Standard
A4	18500g	Standard
A4	18600g	Standard
A4	18700g	Standard
A4	18800g	Standard
A4	18900g	Standard
A4	19000g	Standard
A4	19100g	Standard
A4	19200g	Standard
A4	19300g	Standard
A4	19400g	Standard
A4	19500g	Standard
A4	19600g	Standard
A4	19700g	Standard
A4	19800g	Standard
A4	19900g	Standard
A4	20000g	Standard
A4	20100g	Standard
A4	20200g	Standard
A4	20300g	Standard
A4	20400g	Standard
A4	20500g	Standard
A4	20600g	Standard
A4	20700g	Standard
A4	20800g	Standard
A4	20900g	Standard
A4	21000g	Standard
A4	21100g	Standard
A4	21200g	Standard
A4	21300g	Standard
A4	21400g	Standard
A4	21500g	Standard
A4	21600g	Standard
A4	21700g	Standard
A4	21800g	Standard
A4	21900g	Standard
A4	22000g	Standard
A4	22100g	Standard
A4	22200g	Standard
A4	22300g	Standard
A4	22400g	Standard
A4	22500g	Standard
A4	22600g	Standard
A4	22700g	Standard
A4	22800g	Standard
A4	22900g	Standard
A4	23000g	Standard
A4	23100g	Standard
A4	23200g	Standard
A4	23300g	Standard
A4	23400g	Standard
A4	23500g	Standard
A4	23600g	Standard
A4	23700g	Standard
A4	23800g	Standard
A4	23900g	Standard
A4	24000g	Standard
A4	24100g	Standard
A4	24200g	Standard
A4	24300g	Standard
A4	24400g	Standard
A4	24500g	Standard
A4	24600g	Standard
A4	24700g	Standard
A4	24800g	Standard
A4	24900g	Standard
A4	25000g	Standard

BYK028

Installing the Toner (Print Cartridge)

The following procedure describes how to install the toner.

WARNING

- Do not incinerate toner (new or used) or toner containers. Doing so risks burns. Toner will ignite on contact with naked flame.

WARNING

- Do not store toner (new or used) or toner containers anywhere near naked flames. Doing so risks fire and burns. Toner will ignite on contact with naked flame.

WARNING

- Keep the polythene materials (bags, gloves, etc.) supplied with this machine away from babies and small children at all times. Suffocation can result if polythene materials are brought into contact with the mouth or nose.

CAUTION

- Do not crush or squeeze toner containers. Doing so can cause toner spillage, possibly resulting in dirtying of skin, clothing, and floor, and accidental ingestion.

CAUTION

- Keep toner (used or unused) and toner containers out of reach of children.

CAUTION

- If toner or used toner is inhaled, gargle with plenty of water and move into a fresh air environment. Consult a doctor if necessary.

CAUTION

- If toner or used toner gets into your eyes, flush immediately with large amounts of water. Consult a doctor if necessary.

CAUTION

- If toner or used toner is swallowed, dilute by drinking a large amount of water. Consult a doctor if necessary.

⚠ CAUTION

- When removing jammed paper or replacing toner, avoid getting toner (new or used) on your clothing. If toner comes into contact with your clothing, wash the stained area with cold water. Hot water will set the toner into the fabric and make removing the stain impossible.

⚠ CAUTION

- When removing jammed paper or replacing toner, avoid getting toner (new or used) on your skin. If toner comes into contact with your skin, wash the affected area thoroughly with soap and water.

★ Important

- When you use this printer for the first time, use the four toners supplied with the printer.
- Do not forcefully push toner in.
- When handling toner, never stand them up on either end or position them upside down.

↓ Note

- Toner (consumables) are not covered by warranty. However, if there is problem, contact the store where they were purchased.
- Toner mouths may become dirty during quality inspection.

1. Open the top cover by pulling the handles on the left side.

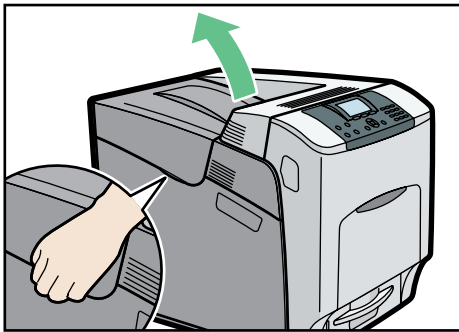

BYK025

2. Take the toner bottle out of its box, and then shake the toner bottle up and down seven or eight times. When holding or shaking the toner bottle, take care to hold the actual bottle, not the bottle's cover.

Even distribution of toner within the bottle improves print quality.

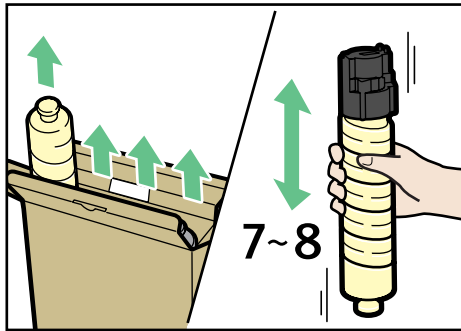

BYK152

3. Install the yellow toner bottle first. Holding the toner bottle horizontally with the label facing up, align the label with the position of the triangular mark.

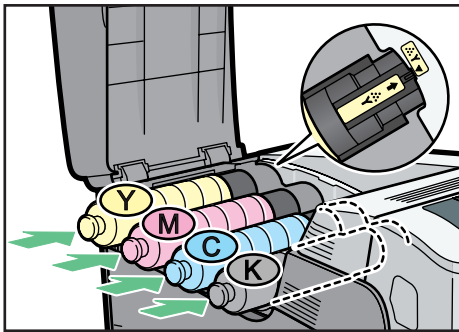

BYK113

Be sure to set the toner bottles so that they are straight and flat.

Carefully align the label on each toner bottle with the triangular mark on the receiving side.

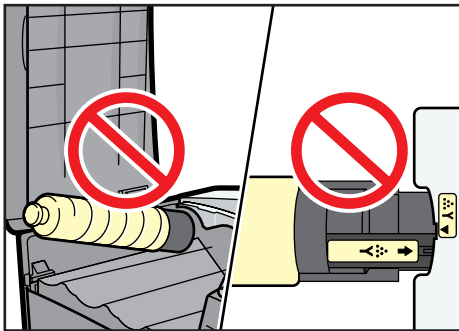

BYK121

4. Push in the toner bottle until you hear a clicking sound.

Do not repeatedly install and remove toner bottle. Doing so results in toner leak.

5. Close the top cover.

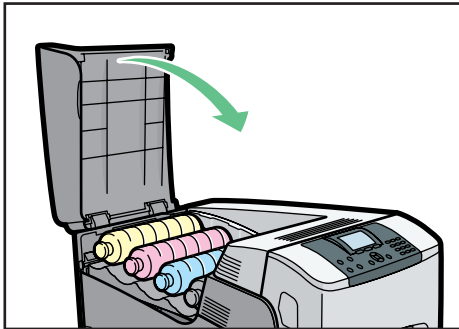

BYK115





Loading Paper

This section describes how to load paper into Standard Paper Feed Tray (Tray 1).

⚠ CAUTION

- Do not pull out the paper tray forcefully. If you do, the tray might fall and cause an injury.

★ Important

- Make sure paper is not stacked higher than the upper limit mark inside the paper tray. Paper misfeeds might occur.
- Do not mix different types of paper in the same paper tray.
- During printing, do not open or close the printer covers or bypass tray, or pull out or push in the paper tray.
- The default setting of tray 1 is as follows:
 -  **Region A** (mainly Europe and Asia)
A4 
 -  **Region B** (mainly North America)
8 1/2 " × 11 " (Letter) 

1. Slowly slide out the paper tray (Tray 1), until it stops. Then, lift the front of the tray slightly, and then pull the tray completely out.

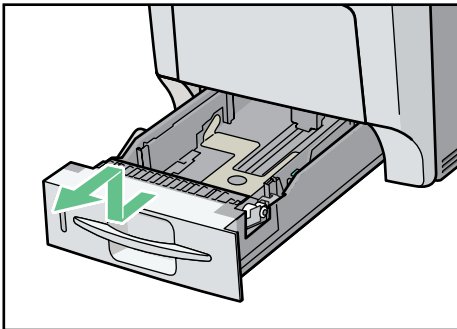

Place the tray on a flat surface.

2. Pinch the green clips on the side guide and the end guide, and then adjust the guides to the paper size being loaded.

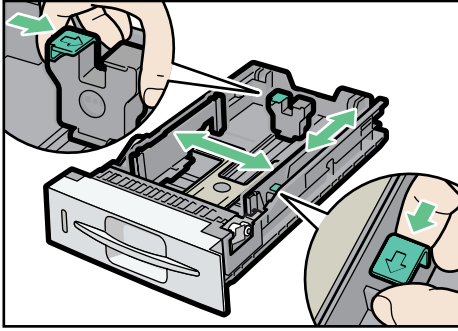

3. Fan the paper before loading paper in the tray.

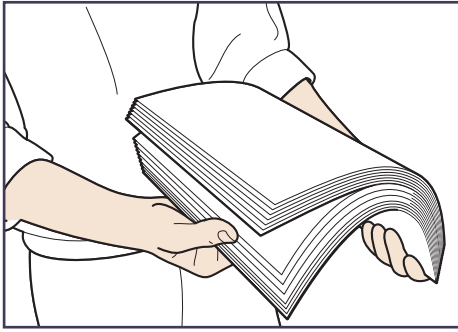

4. Load the new paper stack print side up, making sure the paper is flush against the paper guides.

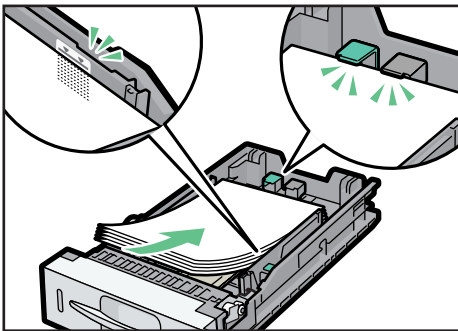

5. Adjust the paper guides to close any gaps.

Do not move paper loaded in the tray more than a few millimeters.

Excessive movement of loaded paper can cause edges of sheets to snag on the openings of the tray's lifting plate, resulting in sheets being folded or becoming jammed.

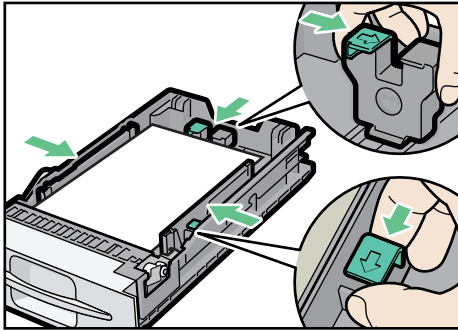

6. Lift the front of the paper tray (Tray 1), and slowly slide the paper tray back in, until it stops. Make sure the tray is fully inserted to prevent a paper misfeed.

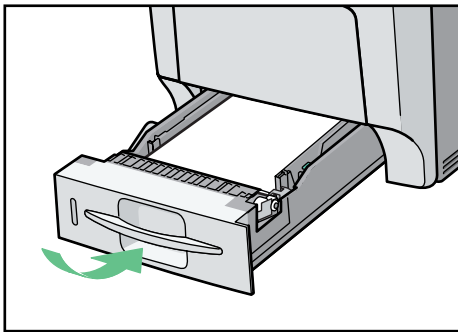

Note

- For details about paper types supported by the printer, see "Types of Paper and Other Media".

Reference

- p.123 "Types of Paper and Other Media"

Turning the Printer's Power On and Off

This section explains the procedures for turning the printer's power on and off.

⚠ WARNING

- It is dangerous to handle the power cord plug with wet hands. Doing so could result in electric shock.

★ Important

- Do not turn off the power switch before following the shutdown procedure shown here. Doing so can result in damage to the hard disk or memory, leading to malfunction.
- Do not physically disturb the printer while printing is in progress. Doing so may damage the printer.

Turning on the Power

Use this procedure to turn on the printer's power.

★ Important

- Make sure the power cord is plugged securely into the wall outlet.
- Turn the power switch off when plugging and unplugging the power plug.

1. Make sure the power switch is set to "○ Off".

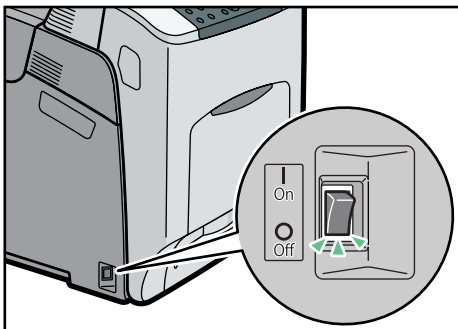

BYK033

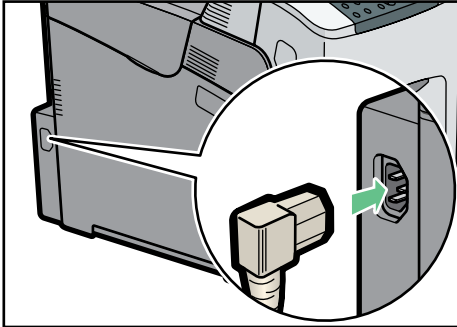
2. Connect the power cord to the connector of the printer.

BYK034

3. Insert the plug of the power cord securely into the wall outlet.**4. Turn the power switch to "I On".**

The power indicator on the control panel lights up.

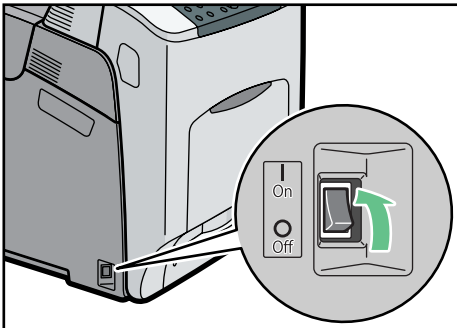

BYK035

Note

- Wait while the toner loads. To avoid malfunction, do not turn off the power while "Loading Toner" is shown on the display.
- Wait until "Ready" appears on the display panel.
- The printer may make a noise while initializing. This noise does not indicate a malfunction.

Turning off the Power

Use this procedure to turn off the printer's power.

2

1. Press the [Menu] key.

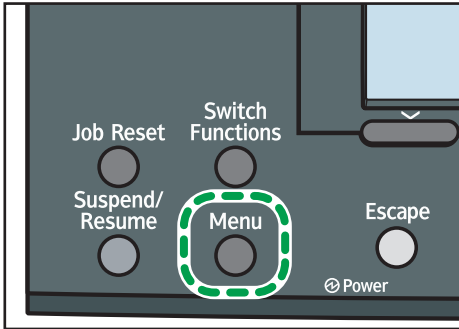

BYK087

2. Press the [▼] or [▲] key to select [Shutdown], and then press the [OK] key.



3. Press [Yes].

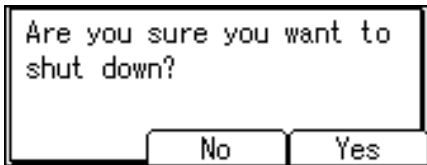

4. Wait until a screen prompting you to turn off the main power appears, and then turn the power switch to "Off".

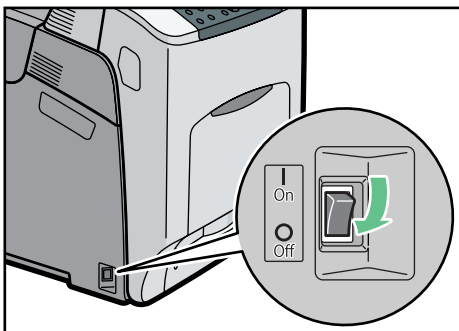

BYK122

Note

- Even if you follow the shutdown procedure, the printer might not shutdown in the following cases:
 - If it is communicating with external devices.
 - If the hard disk is active.

- If the printer's cover is opened.

Selecting the Display Language

Select a language using the procedure described here. The message in the selected language will appear on the display.

2

1. Press the [Menu] key.

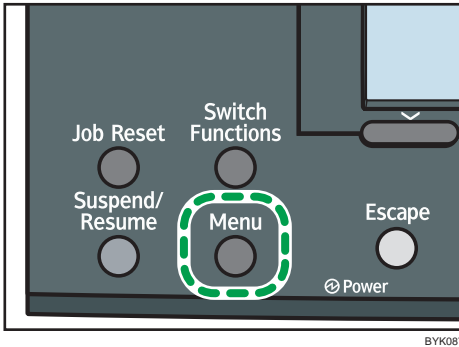

2. Press the [▼] or [▲] key to select [Language], and then press the [OK] key.



3. Press the [▼] or [▲] key to select the preferred language, and then press the [OK] key.



4. Press the [Menu] key to return to the initial screen.

Note

- The default setting is English.

Test Printing

Print a test print in order to verify that the printer is working normally. Test printing checks printer performance only; it does not test the connection to the computer.

1. Press the [Menu] key.

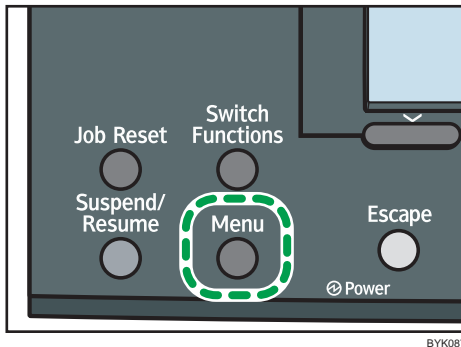

2

2. Press the [▼] or [▲] key to select [List/Test Print], and then press the [OK] key.



3. Press the [▼] or [▲] key to select [Config. Page], and then press the [OK] key.

The configuration page will be printed.



4. Press the [Menu] key to return to the initial screen.

Note

- If printing is not normal, check to see if an error message appears on the display. If there is an error message, see "Troubleshooting".

Reference

- p.197 "Troubleshooting"

Installing the ELP-NX Card

This section explains how to install the ELP-NX card. The following procedure applies to Type 2 model only.

CAUTION

- Keep SD memory cards out of reach of children. If a child swallows an SD memory card, consult a doctor immediately.

Important

- To complete the installation process of the ELP-NX card, you must restart the printer.
- Do not subject the card to physical shocks.
- Use the lower slot for the SD card.

1. Make sure the power switch is set to "Off", and then unplug the power cord.

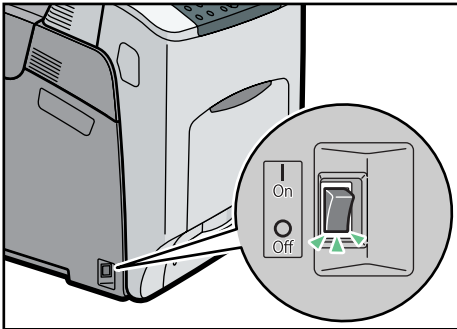

BYK033

2. Remove the cover of the controller board's lower SD card slot.

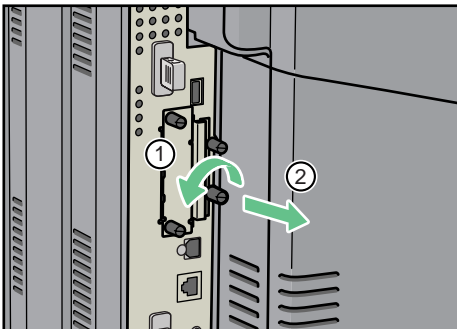

BYK600

- Carefully push in the SD card (notched corner upward and leading), until it clicks into place.

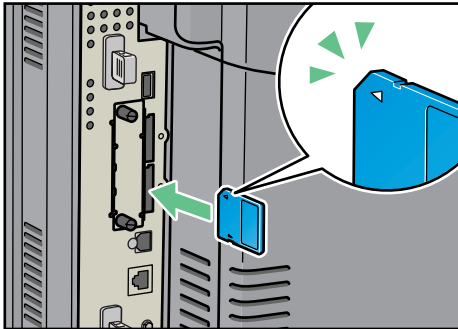

BYK601

- Reattach the cover over the SD card. Fasten the screw to secure the cover.

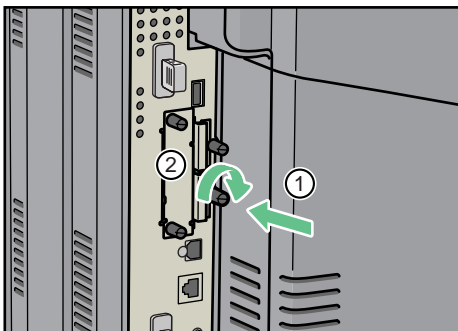

BYK602

- Insert the plug of the power cord securely into the wall outlet.
- Turn the power switch to "I On".

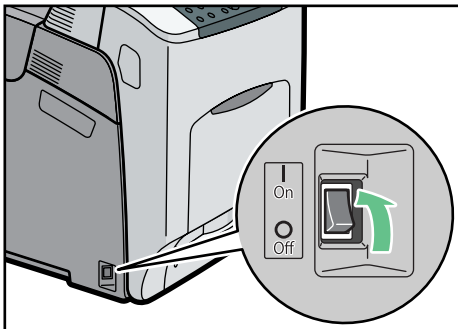

BYK035

The power indicator on the control panel lights up and the application installation process starts automatically. The initial screen will appear.

- Perform the shutdown procedure, and then turn the power switch to "O Off".
- Turn the power switch to "I On".

The power indicator on the control panel lights up.

Note

- Do not touch the card while the printer is in use. It may come loose, even if pushed only slightly. The slot cover must be reattached.
- You can confirm that the ELP-NX card was installed correctly by checking Web Image Monitor. For details, see "Extended Feature Info", VM Card Extended Feature Settings Web Reference.
- If the card is not installed properly, repeat the procedure from the beginning. If it cannot be installed correctly even after reattempting installation, contact your sales or service representative.

3. Installing Options

This chapter explains how to install various options for this printer.

Available Options

By installing options, you can improve printer performance and expand the available features.

CAUTION

- Before installing or removing options, always remove the power cords from the wall outlet and allow time for the main unit to fully cool. Failing to take these precautions could result in burns.

3

Order of Option Installation

When installing multiple options, the following order is recommended:

1. Attach the paper feed unit.

Attach the paper feed units to the bottom of the printer.

You can attach up to three paper feed units. Up to 2300 sheets of paper can be loaded in total.

If the paper feed unit is set on the floor, the tip-resistant caster table (option) is required for safe usage. The tip-resistant caster table can only be installed by a service representative. Contact your service representative for details.

2. If you are using Type 1 model, install the SDRAM module.

Install the expansion memory in the controller board slot.

There are two types of memory units, 256 MB and 512 MB.

3. If you are using Type 1 model, install the hard disk.

4. Install the optional interface board.

Install the optional Gigabit Ethernet board, Wireless LAN interface unit, or IEEE 1284 interface board in the slot.

5. Insert SD card options.

Install the Data overwrite security unit, NetWare card, camera direct print card, VM card, or HDD encryption unit.

Insert these units into the SD card slot on the controller board.

If you want to use two or more SD cards that can be inserted in the same slot, contact your sales and service representative.

Where to Install Options

Install options in the locations shown in the following illustrations.

External options

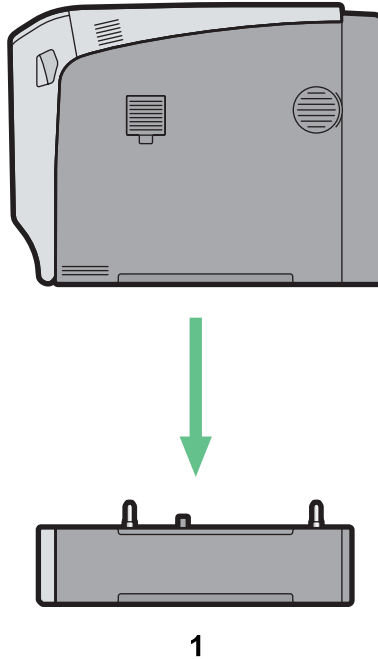

BYK036

1. Paper feed unit

Loads up to 550 sheets of paper. Up to three paper feed units can be installed on the printer. Installed tray units are identified as "Tray 2", "Tray 3", and "Tray 4". For details about attaching the paper feed units, see "Attaching the Paper Feed Unit".

Interior

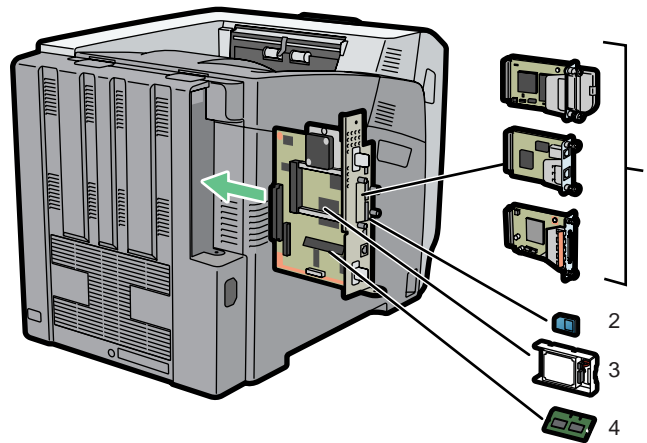

BYK037

1. Optional interface boards

- Wireless LAN interface unit
- Gigabit Ethernet board
- IEEE 1284 interface board

For details about installing these options, see "Installing the Interface Units".

2. SD card options

For details about installing these options, see "Installing the SD Memory Card Options".

3. Hard disk

For details about this option, see "Installing the Memory Expansion Units".

4. SDRAM module

For details about this option, see "Installing the Memory Expansion Units".

↓ Note

- For details about the specifications of each option, see "Specifications".

📖 Reference

- p.63 "Attaching the Paper Feed Unit"
- p.67 "Installing the Memory Expansion Units"
- p.75 "Installing the Interface Units"
- p.82 "Installing the SD Memory Card Options"
- p.232 "Specifications"

Cautions When Re-installing the Controller Board

This section describes handling the controller board when installing options.

If you slide out the controller board to install the SDRAM module or hard disk, carefully follow the instruction below to re-install the controller board.

★ Important

- The following may occur if the controller board is not correctly installed:
 - All control panel indicators are lit.
 - No control panel indicators are lit.
 - The "SC670" error message appears on the display.

Re-install the controller board in the printer. To do this, grip the handles on the back of the board and push the board in until it stops.

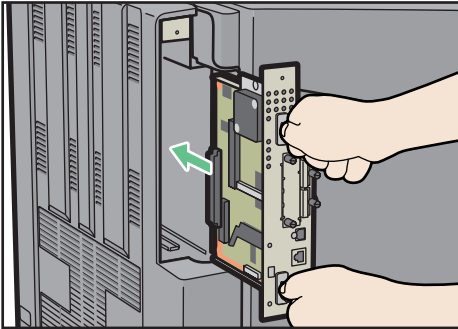

BYK043

Attaching the Paper Feed Unit

WARNING

- If the machine topples, or if a cover or other part gets broken, you must turn the power switch to off and disconnect the power cord plug from the wall outlet. Then contact your service representative and report the problem. Do not use the machine. Doing so could result in fire or electric shock.

CAUTION

- The printer weighs approximately 57 kg (126 lb.). When moving the printer, use the inset grips on both sides, and lift slowly. The printer will break or cause injury if dropped.

CAUTION

- Unplug the power cord from the wall outlet before you move the machine. While moving the machine, take care that the power cord is not damaged under the machine. Failing to take these precautions could result in fire or electric shock.

CAUTION

- Do not place the machine on an unstable or tilted surface. If it topples over, an injury might occur.

CAUTION

- The tip-resistant caster table is required if the printer is to be used while placed on the floor with the optional paper feed unit installed. Not using the tip-resistant caster table risks injury to users and damage to the printer resulting from toppling. The tip-resistant caster table can only be installed by a service representative. Contact your service representative for details.

Important

- Up to three paper feed units can be attached to the printer.
- When three paper feed units are installed, they are detected as "Tray 2", "Tray 3", and "Tray 4", starting from the upper unit.
- The printer should always be lifted by at least four people.
- Before using the new paper feed unit, you must make settings in the printer driver.

1. Check the package contains the following:
Paper Feed Unit (including a paper tray)

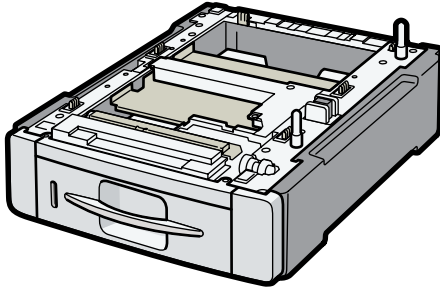

BYK038

2. Turn off the power, and then unplug the power cord.
3. Remove the stowage tapes from the paper feed unit.
4. Lift the printer with four people by using the inset grips on both sides of the printer.

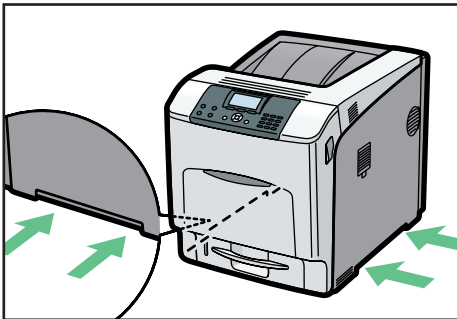

BYK157

When moving the printer, do not hold on the following parts as doing so could cause a malfunction:

- The handle onto the standard paper feed tray.
- The underside of the bypass tray.
- The underside of the box containing the controller board (on the back of the printer).

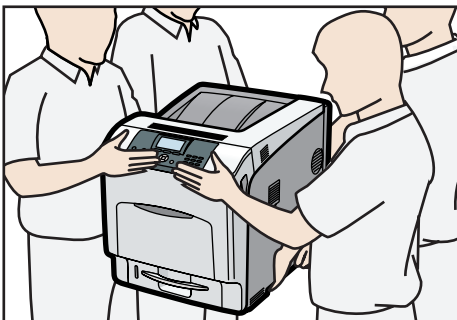

BYK015

5. Align the printer with the two upright pins on the paper feed unit and then lower the printer slowly.

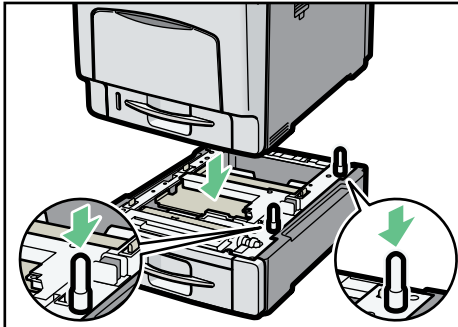

When installing two or three units, first connect the units to each other (using the same procedure as described above), and then connect them as a single unit to the printer.

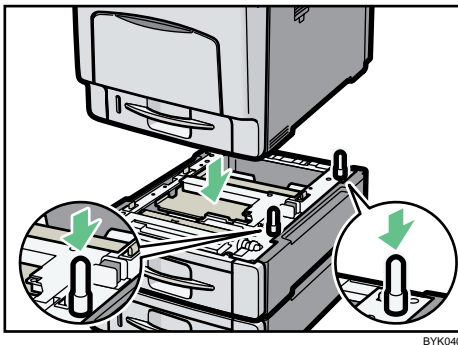

Note

- When moving the printer, remove the paper feed unit.
- After finishing the installation, you can check whether the paper feed unit is properly installed by printing the configuration page from the [List/Test Print] menu. If the paper feed unit is properly installed, "Tray 2", "Tray 3", and "Tray 4" will appear for "Attached Equipment" on the configuration page.
- If the paper feed unit is not installed properly, reinstall it following this procedure. If you cannot install it properly even after attempting reinstallation, contact your sales or service representative.
- If the print area is not centered correctly, adjust the printing position for the optional paper feed unit. For details, see "Adjusting Printing Position".
- For details about printing the configuration page, see "Test Printing".
- For details about loading paper onto the paper tray, see "Loading Paper".

Reference

- p.55 "Test Printing"
- p.138 "Loading Paper"

- p.192 "Adjusting Printing Position"

Installing the Memory Expansion Units

The following procedure applies to Type 1 model only.

⚠ CAUTION

- Do not touch the inside of the controller board compartment. It may cause a machine malfunction or a burn.

Installing the SDRAM Module

3

★ Important

- Before touching the SDRAM module, ground yourself by touching something metal to discharge any static electricity. Static electricity can damage the SDRAM module.
 - Do not subject the memory unit to physical shocks.
 - The printer comes equipped with 384 MB of memory. This can be expanded to a maximum of 768 MB.
 - Before using the new memory unit, you must configure settings in the printer driver.
1. Turn off the power, and then unplug the power cord.
 2. Remove the two screws securing the controller board.

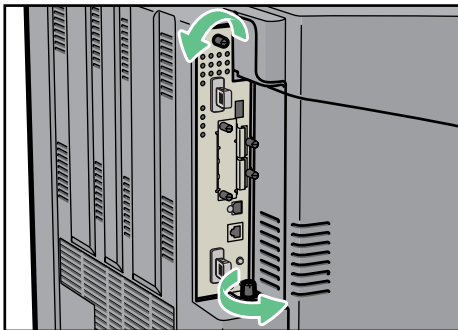

BYK041

3. Gripping the handles, carefully pull out the controller board.

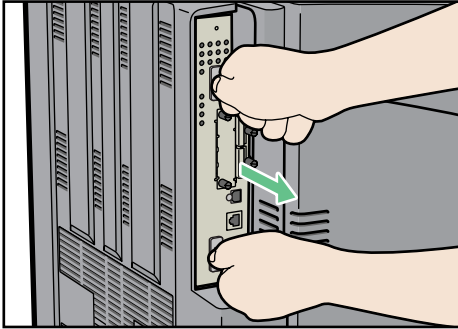

BYK042

4. Place the controller board on a flat surface.

The Memory Unit is installed in the slot shown in the illustration below.

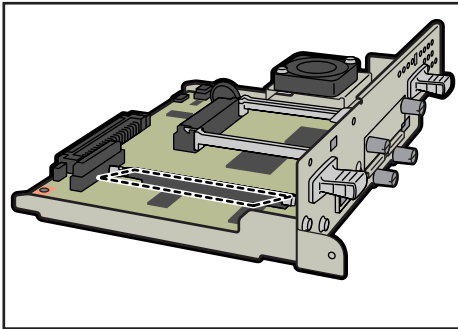

BYK045

5. Push the levers on both ends of the slot outward (①), and then remove the default module (②).

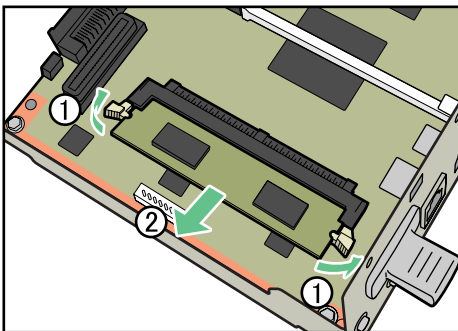

BYK048

Install a new SDRAM module.

- Align the notch of the SDRAM module with the protrusion in the memory slot, then press the module at an angle into the memory slot.

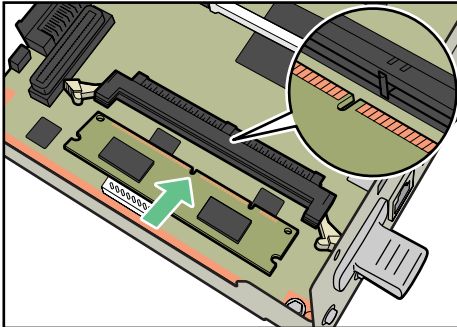

BYK046

- Push in the SDRAM module firmly until it clicks into place.

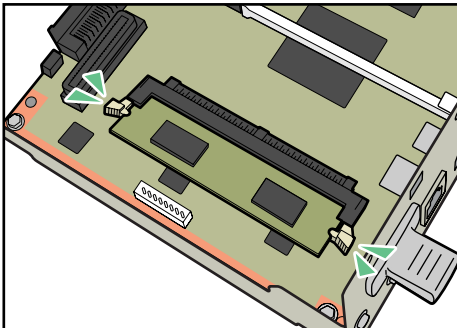

BYK047

- Align the controller board with the top and bottom rails, and then push it carefully in, until it stops.

The printer may malfunction if the controller board is not properly installed.

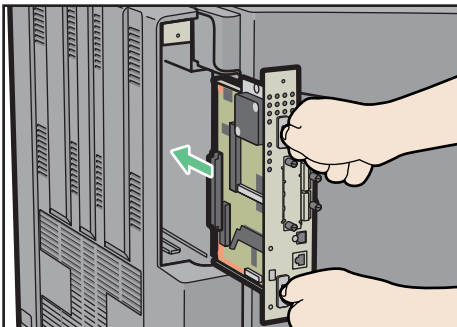

BYK043

9. Fasten the controller board to the printer using the two screws.

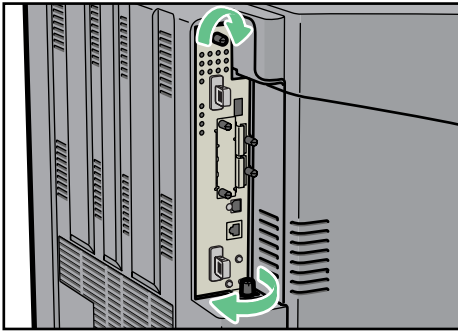

BYK044

↓ Note

- After finishing the installation, you can check the memory unit is properly installed: Print the configuration page from the [List/Test Print] menu. If it is installed properly, the memory capacity will appear under "Total Memory" on the configuration page.
- The following table shows the total capacities of the SDRAM modules in Type 1 model.

Standard	Extended	Total
256 + 128 MB	256 MB	512 MB
256 + 128 MB	512 MB	768 MB

- If the memory unit is not properly installed, repeat this procedure. If you cannot install it properly even after reinstallation, contact your sales or service representative.
- For details on printing the configuration page, see "Test Printing".

📖 Reference

- p.55 "Test Printing"

Installing the Hard Disk

★ Important

- Before touching the hard disk, touch something metal to discharge any static electricity. Static electricity can damage the hard disk.
- Do not subject the hard disk to physical shocks.
- Install the hard disk carefully if the SDRAM module is already installed. If the hard disk comes into contact with the SDRAM module, the SDRAM module may be damaged.
- Before using the new hard disk, be sure to reconfigure the printer driver settings.

1. Check the package contains the followings:

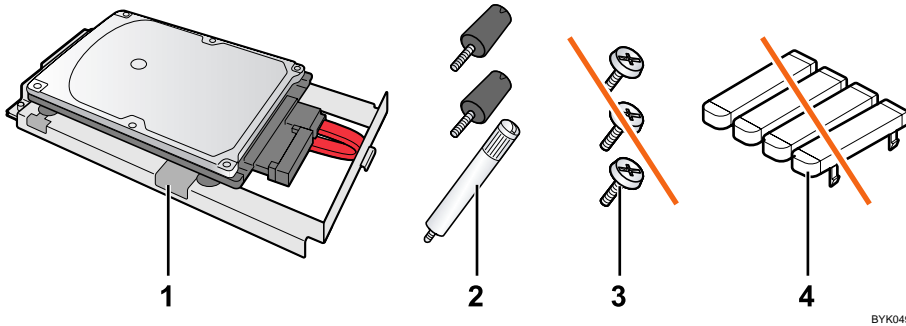

1. Hard Disk
2. Three Screws
3. Screws for Other Models
4. Key Tops

2. Turn off the power, and then unplug the power cord.

3. Remove the two screws securing the controller board.

The removed screws will be used to secure the controller board again later.

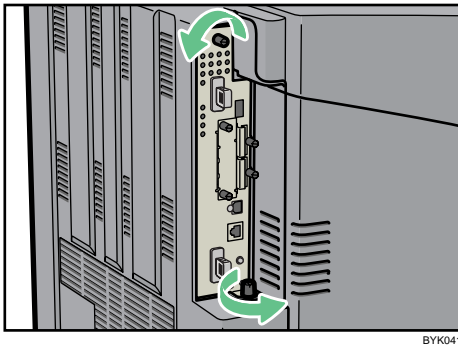

4. Gripping the handles, carefully pull out the controller board.

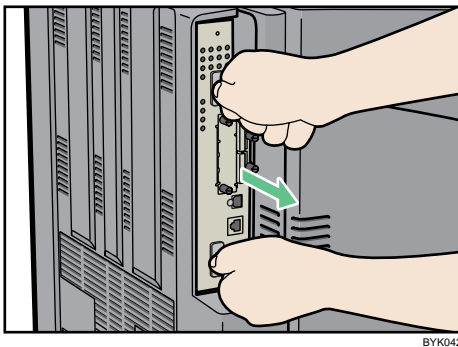

5. Place the controller board on a flat surface.

The hard disk is installed in the slot shown in the illustration below.

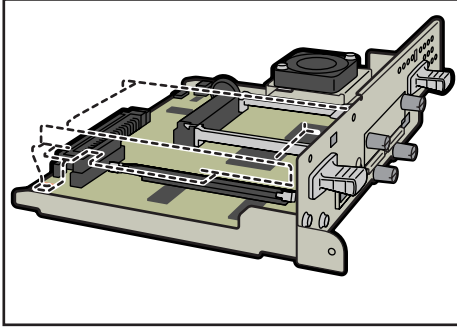

BYK050

6. Insert the protrusion on the front end of the hard disk board into the notch on the back panel of the controller board.

Be sure to set the hard disk board parallel with the controller board.

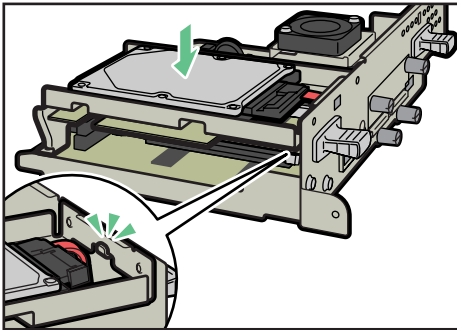

BYK051

7. Fit the hard disk on the connector of the controller board carefully until it stops.

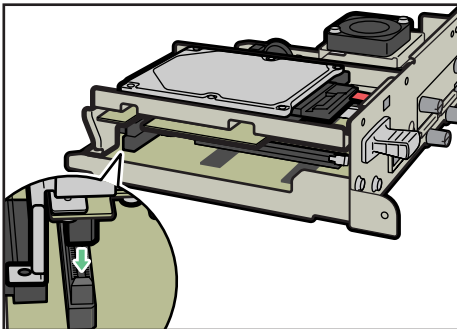

BYK052

8. Fasten the hard disk to the controller board using the two screws.

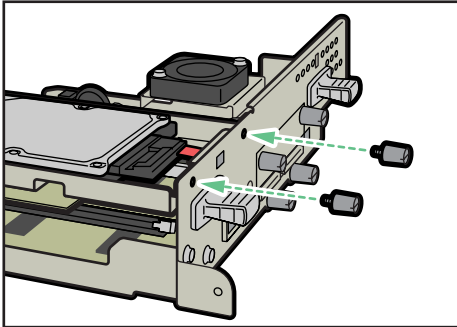

BYK053

9. Fasten the hard disk to the controller board using the screw.

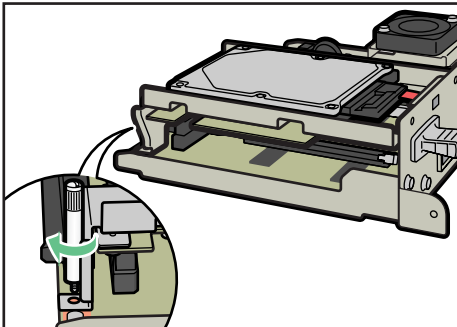

BYK054

10. Align the controller board with the top and bottom rails, and then push it carefully in, until it stops.

The printer may malfunction if the controller board is not properly installed.

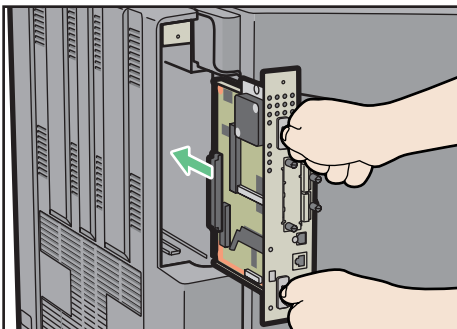

BYK043

11. Fasten the controller board to the printer using the two screws.

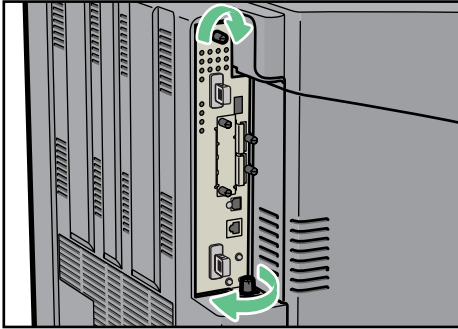

BYK044

3

Note

- After finishing installation, you can check the hard disk is properly installed: Print the configuration page from the [List/Test Print] menu. If it is installed properly, you will see "Hard Disk" for "Device Connection" on the configuration page.
- If the hard disk is not properly installed, repeat this procedure. If you cannot install it properly even after reinstallation, contact your sales or service representative.
- For details on printing the configuration page, see "Test Printing".

Reference

- p.55 "Test Printing"

Installing the Interface Units

Installing the Gigabit Ethernet Board

★ Important

- The printer's Ethernet and USB ports are not available when the Gigabit Ethernet board is installed in to the printer. Use the Ethernet and USB ports on the Gigabit Ethernet board.
- Before beginning work, ground yourself by touching something metal to discharge any static electricity. Static electricity can damage the Gigabit Ethernet board.
- Do not subject the Gigabit Ethernet board to physical shocks.

1. Check the contents of the package.

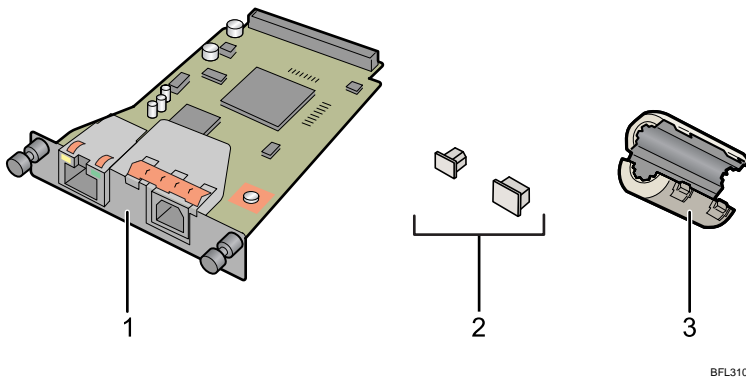

1. Gigabit Ethernet Board

2. Protective caps (one each for the Ethernet port and the USB port)

3. Ferrite core

Design of the ferrite core varies according to printer model.

2. Turn off the power, and then unplug the power cord.

3. Disconnect the cables from the Ethernet port and the USB port of the printer, and cover each port with its protective cap.

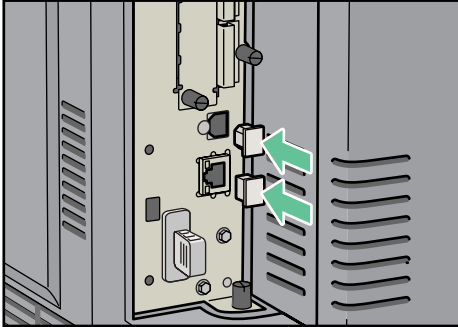

4. Remove the two screws and remove the cover of the slot in which the Gigabit Ethernet board is installed.

The removed cover is not used when the interface unit is installed.



5. Fully insert the Gigabit ethernet board.

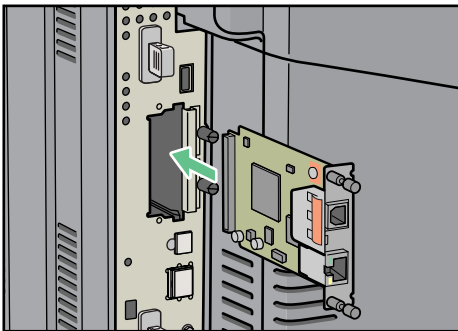

6. Tighten the two screws to secure the Gigabit ethernet board.

Check the Gigabit ethernet board is connected firmly to the controller board.

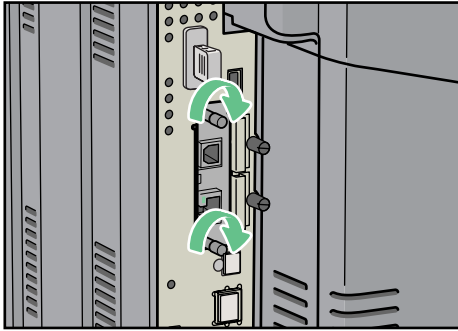
**Note**

- Confirm that the Gigabit Ethernet board was correctly installed by printing the configuration page. If it is correctly installed, "Gigabit Ethernet" will appear for "Device Connection" on the configuration page.
- If the board was not installed properly, repeat the procedure from step 2. If it cannot be installed correctly even after reattempting installation, contact your sales or service representative.
- For details about printing the configuration page, see "Test Printing".
- Before using the Gigabit Ethernet board, you must configure settings from the printer control panel. For details, see "Ethernet Configuration".

Reference

- p.55 "Test Printing"
- p.93 "Ethernet Configuration"

Installing the Wireless LAN Interface Board

Important

- Before beginning work, ground yourself by touching something metal to discharge any static electricity. Static electricity can damage the unit.
- Do not subject the unit to physical shocks.

3

1. Check the contents of the package.

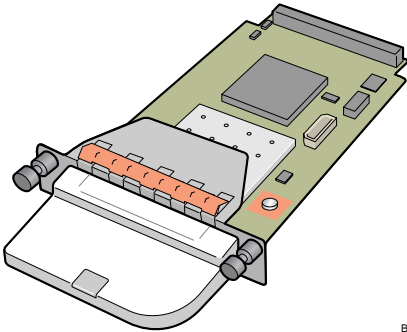

BFL301S

2. Turn off the power, and then unplug the power cord.
3. Remove the two screws and remove the cover of the slot in which the Wireless LAN interface board is installed.

The removed cover is not used when the interface board is installed.



BYK056

4. Fully insert the Wireless LAN interface board.

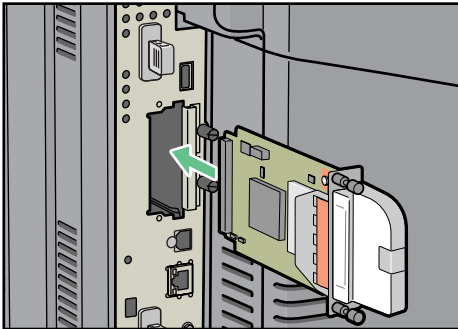

BYK061

5. Tighten the two screws to secure the interface board.

Check the Wireless LAN interface board is connected firmly to the controller board.

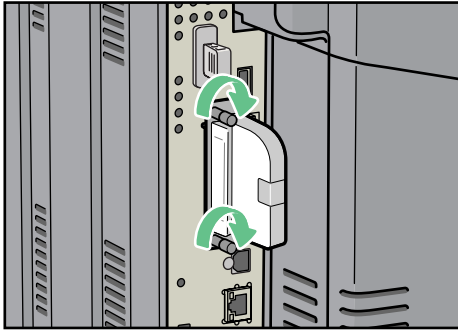
**Note**

- Confirm that the interface board was correctly installed by printing the configuration page. If it is correctly installed, "Wireless LAN" will appear for "Device Connection" on the configuration page.
- If the board was not installed properly, repeat the procedure from step 2. If it cannot be installed correctly even after reattempting installation, contact your sales or service representative.
- For details about printing the configuration page, see "Test Printing".
- Before using the Wireless LAN interface board, you must configure settings from the printer control panel. For details, see "Wireless LAN Configuration".

Reference

- p.55 "Test Printing"
- p.104 "Wireless LAN Configuration"

Installing the IEEE 1284 Interface Board

Important

- Before beginning work, ground yourself by touching something metal to discharge any static electricity. Static electricity can damage the IEEE 1284 interface board.
- Do not subject the IEEE 1284 interface board to physical shocks.
- For connection to the IEEE 1284 interface board, use a half pitch 36-pin interface cable.

1. Check the contents of the package.

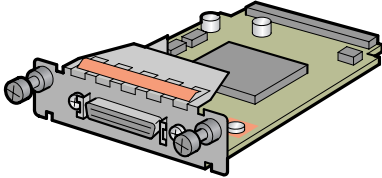

BFL302S

- 2. Turn off the power, and then unplug the power cord.**
- 3. Remove the two screws and remove the cover of the slot in which the 1284 interface board is installed.**

The removed cover is not used when the 1284 interface board is installed.



BYK056

4. Fully insert the IEEE 1284 interface board.

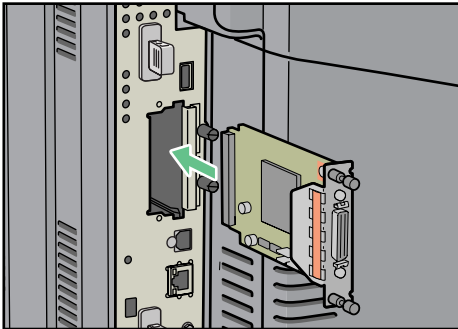

BYK064

5. Tighten the two screws to secure the interface board.

Check the IEEE 1284 interface board is connected firmly to the controller board.

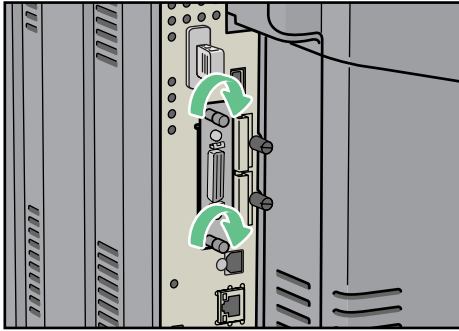

BYK065

Note

- Confirm that the IEEE 1284 interface board was correctly installed by printing the configuration page. If it is correctly installed, "Parallel Interface" will appear for "Device Connection" on the configuration page.
- If the board was not installed properly, repeat the procedure from step 2. If it cannot be installed correctly even after reattempting installation, contact your sales or service representative.
- For details about printing the configuration page, see "Test Printing".

Reference

- p.55 "Test Printing"

Installing the SD Memory Card Options

This section explains how to install the following SD cards: the camera direct print card, data overwrite security unit, HDD encryption unit, NetWare card, and VM card.

CAUTION

- Keep SD memory cards out of reach of children. If a child swallows an SD memory card, consult a doctor immediately.

3

Important

- Do not subject the card to physical shocks.

Note

- The VM card is optional to Type 1 models only. To use it, the optional 512 MB SDRAM module must be installed.

1. Check the contents of the package.

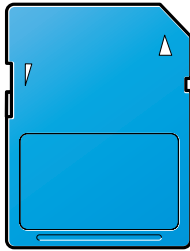

BFL308S

2. Turn off the power, and then unplug the power cord.
3. Remove the two screws, and then carefully remove the cover of the SD card slot.

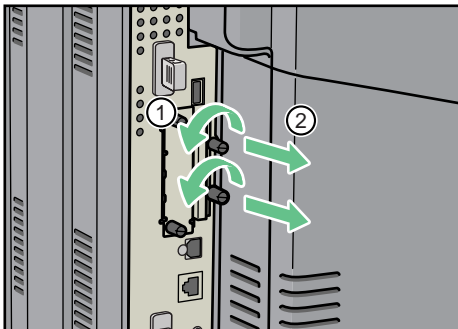

BYK066

4. Carefully push in the SD card (notched corner upward and leading), until it clicks into place.

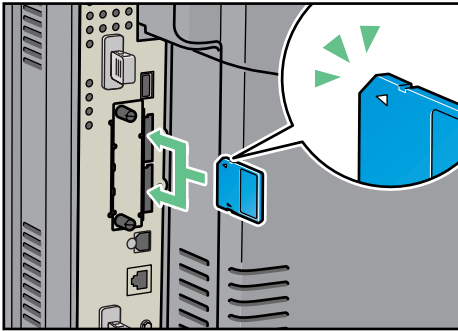

BYK067

Insert the SD card in the appropriate slot as follows:

- Upper slot: Camera direct print card, Data overwrite security unit, NetWare card
- Lower slot: HDD encryption unit, VM card

5. Reattach the cover over the SD card. Fasten the two screws to secure the cover.

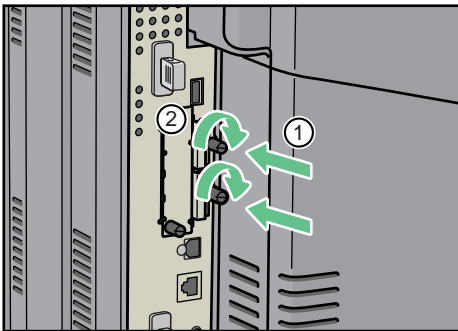

BYK068

Note

- Do not touch the card while the printer is in use. It may come loose, even if pushed only slightly. The slot cover must be reattached.
- You can confirm that the SD card was installed correctly by checking the control panel menu. Depending on the SD card, certain menu items appear on the display.
 - Data overwrite security unit: [Memory Erase Status] appears on the top level menu.
 - HDD encryption unit: [Machine Data Encryption] appears in [Security Options].
- Confirm that the camera direct print card was correctly installed by printing the configuration page. If the camera direct print card is installed properly, "PictBridge" will appear for "Attached Equipment" in "System Reference".
- If the card is not installed properly, repeat the procedure from the beginning. If it cannot be installed correctly even after reattempting installation, contact your sales or service representative.
- For details about printing the configuration page, see "Test Printing".

 **Reference**

- p.55 "Test Printing"

4. Connecting the Printer

This chapter explains how to connect network and USB cables.

Ethernet Cable Connection

Prepare a hub and other network devices, and connect the Ethernet cable to the printer.

Connect 10BASE-T or 100BASE-TX cable to the printer's Ethernet port. For 1000BASE-T, the optional Gigabit Ethernet board is required.

CAUTION

- A network interface cable with a ferrite core must be used for RF interference suppression.

CAUTION

- For users outside the United States of America: properly shielded and grounded cables and connectors must be used for connections to a host computer (and/or peripheral) in order to meet emission limits.

CAUTION

- For users in the United States of America: properly shielded and grounded cables and connectors must be used for connections to a host computer (and/or peripheral) in order to meet FCC emission limits.

Important

- An Ethernet cable is not supplied with this printer. Select your cable according to the network environment.
- The printer's Ethernet and USB ports are not available when the Gigabit Ethernet board is attached to the printer.

Connecting to the standard Ethernet port

1. Attach the supplied ferrite core at the printer end of the Ethernet cable.

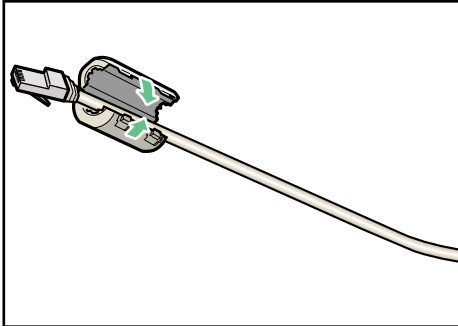

BYK169

2. Connect the Ethernet cable to the Ethernet port.

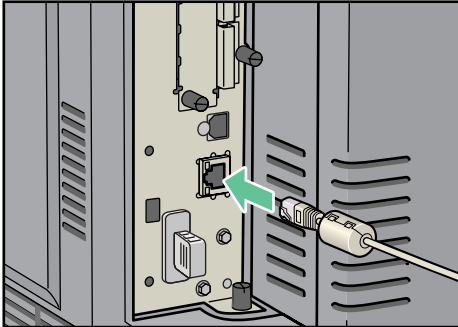

BYK069

3. Connect the other end of the cable to the network, for example using a hub.

Connecting to the Ethernet port of the Gigabit Ethernet board

1. Attach two ferrite cores to the Ethernet cable.

Attach the core supplied with the printer to the connector end, and the one supplied with the Gigabit Ethernet board about 10 cm (4 inches) from the connector end (①), making a loop as shown.

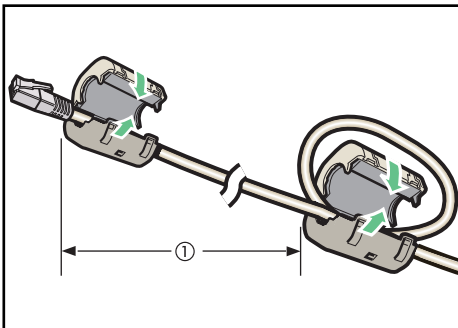

BYK170

2. Connect the Ethernet cable to the Ethernet port of the Gigabit Ethernet board.

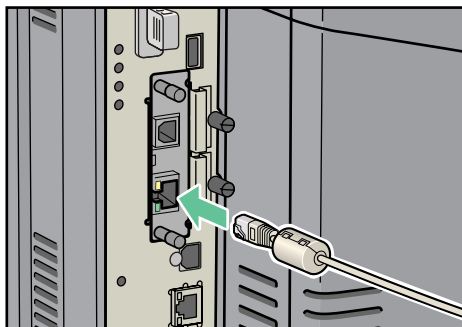

BYK070

3. Connect the other end of the cable to the network, for example using a hub.

↓ Note

- For details about configuring the network environment, see "Ethernet Configuration".
- For details about installing the Gigabit Ethernet board, see "Installing the Interface Units".

📖 Reference

- p.75 "Installing the Interface Units"
- p.93 "Ethernet Configuration"

4

Reading the LED Lamps

Standard Ethernet port

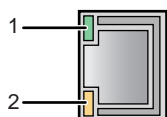

BYK109

1. Green indicator

If the printer is connected to a 10BASE-T Ethernet, the green indicator will be lit. This indicator will be unlit if the printer is connected to a 100BASE-TX Ethernet.

2. Yellow indicator

If the printer is connected to a 100BASE-TX Ethernet, the yellow indicator will be lit. This indicator will be unlit if the printer is connected to a 10BASE-T Ethernet.

Optional Gigabit Ethernet board

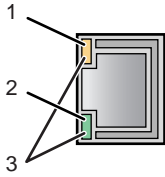

BYK110

1. Yellow indicator

If the printer is connected to a 100BASE-TX Ethernet, the yellow indicator will be lit. This indicator will be unlit if the printer is connected to a 10BASE-T Ethernet.

2. Green indicator

If the printer is connected to a 10BASE-T Ethernet, the green indicator will be lit. This indicator will be unlit if the printer is connected to a 100BASE-TX Ethernet.

3. Green and yellow indicators

If the printer is connected to a 1000BASE-T Ethernet, both indicators will be lit.

USB Cable Connection

⚠ CAUTION

- For users outside the United States of America: properly shielded and grounded cables and connectors must be used for connections to a host computer (and/or peripheral) in order to meet emission limits.

⚠ CAUTION

- For users in the United States of America: properly shielded and grounded cables and connectors must be used for connections to a host computer (and/or peripheral) in order to meet FCC emission limits.

★ Important

- USB connection is possible under Windows 2000/XP/Vista, Windows Server 2003/2003 R2/2008, and Mac OS X 10.3.3 or later.
- USB connection with Mac OS is only possible via the printer's USB port, not the Gigabit Ethernet board's USB port.
- A USB cable is not supplied with this printer. Select your cable according to the computer.

1. Connect the USB cable to the printer.

- **Connecting the USB cable to the standard USB port B**

Connect the smaller connector of the USB cable to the standard USB port B on the left side of the printer.

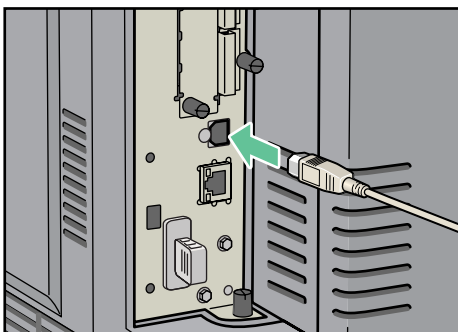

BYK071

- **Connecting the USB cable to the Gigabit Ethernet board USB port**

Connect the smaller connector of the USB cable to the USB port of the Gigabit Ethernet board.

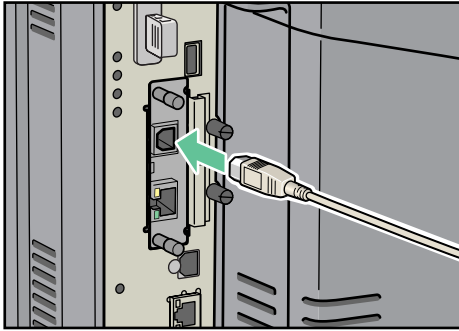

4

2. Connect the opposite end's flat connector to the desired device such as your computer's USB interface, or a USB hub.

The printer is now connected to the computer. The Plug and Play screen appears on the computer display. For details, see "Installing the Printer Driver Using USB", Driver Installation Guide.

Digital Camera Connection

This printer supports direct printing, which allows you to print images taken with a digital camera by connecting the camera directly to the printer. The following describes how to connect the printer to a digital camera.

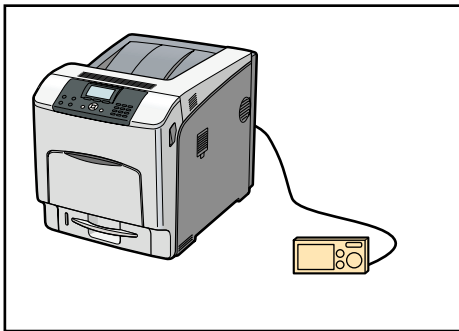

★ Important

- This function requires the Camera direct print card.
- Use the USB cable bundled with your digital camera.
- Make sure your digital camera supports PictBridge.

1. Confirm that the printer and digital camera are turned on.

2. Connect the USB cable to the standard USB port A on the printer and to your digital camera.

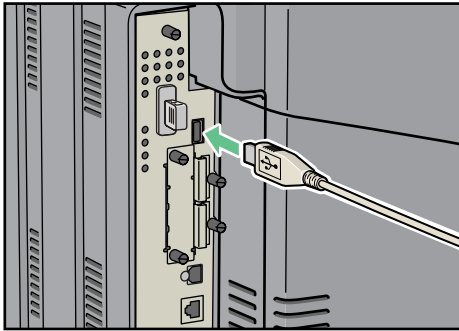

3. When a digital camera is not connected to the printer, store the USB cable in a location where it will not be damaged.

↓ Note

- For details about the printing method, see "PictBridge Printing", Software Guide.
- For details about installing the Camera Direct Print card, see "Installing the SD Memory Card Options".

📖 Reference

- p.82 "Installing the SD Memory Card Options"

Parallel Cable Connection

The type of cable required varies depending on the computer you are using. Make sure to use the interface cable compliant with your computer.

⚠ CAUTION

- For users outside the United States of America: properly shielded and grounded cables and connectors must be used for connections to a host computer (and/or peripheral) in order to meet emission limits.

⚠ CAUTION

- For users in the United States of America: properly shielded and grounded cables and connectors must be used for connections to a host computer (and/or peripheral) in order to meet FCC emission limits.

4

★ Important

- The printer's parallel connection is a standard bidirectional interface that requires an IEEE 1284-compliant half pitch 36-pin parallel cable and host computer parallel port.
- Use shielded interface cable. Unshielded cables create electromagnetic interference.

1. Turn off the printer and computer.
2. Connect the interface cable to the IEEE 1284 interface board.

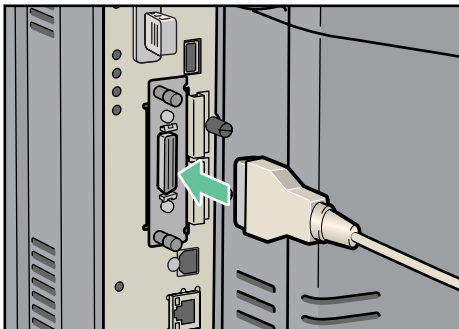

3. Connect the other end of the interface cable to your computer, and then secure the cable.

The printer is now connected to the computer. Install the printer driver. For details, see "Installing the Printer Driver Using Parallel Cable", Driver Installation Guide.

↓ Note

- For details about installing the 1284 interface board, see "Installing the Interface Units".

📖 Reference

- p.75 "Installing the Interface Units"

5. Configuration

This chapter explains supported network connections, and settings for the IP addresses and the Wireless LAN security.

Ethernet Configuration

Configure the following network settings according to the network interface you are using. You can use SmartDeviceMonitor for Admin or a Web browser to configure IP address-related settings in a TCP/IP-capable environment.

★ Important

- Configure the printer for the network using the control panel.
- The following table shows the control panel settings and their default values. These items appear in the [Host Interface] menu.

Setting Name	Default
Machine IPv4 Address	<ul style="list-style-type: none">• DHCP: On• IPv4 Address: 11.22.33.44• Subnet Mask: 0.0.0.0• Gateway Address: 0.0.0.0
IPv6 Stateless Setting	Active
IPsec	Inactive
NW Frame Type	Auto Select
Effective Protocol	<ul style="list-style-type: none">• IPv4: Active• IPv6: Inactive• NetWare: Inactive• SMB: Active• AppleTalk: Inactive
Ethernet Speed	Auto Select
IEEE802.1X Auth.(Ethernet)	Inactive
Restr.IEEE802.1X Auth.Def.	-
LAN Type	Ethernet

↓ Note

- If DHCP is in use on your network, the IP address, subnet mask, and gateway address are all set automatically.
- If the printer is already placed on a TCP/IP-capable environment, you can also use a Web browser to configure the IP address-related settings.
- Configure these setting as necessary. See Software Guide for details.

Specifying an IP Address (No DHCP)

Follow this procedure to assign a specific IP address to the printer. This is only necessary when you will use the printer on a network without DHCP, or want to prevent the printer's IP address from changing.

Before beginning, make sure that you know the IP address, subnet mask and gateway address that the printer will use.

5

1. Press the [Menu] key.

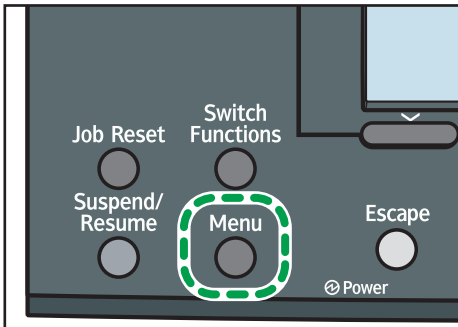

BYK087

2. Press the [▼] or [▲] key to select [Host Interface], and then press the [OK] key.

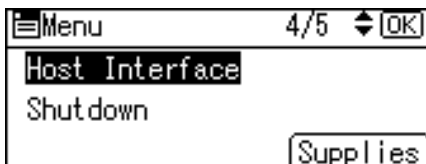

3. Press the [▼] or [▲] to select [Network], and then press the [OK] key.

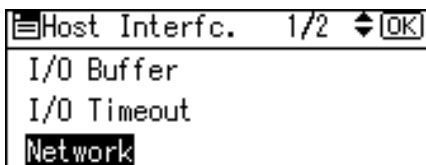

4. Press the [▼] or [▲] key to select [Effective Protocol], and then press the [OK] key.

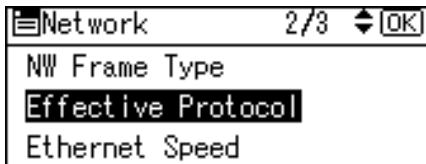

5. Press the [▼] or [▲] key to select the appropriate network protocol, and then press the [OK] key.

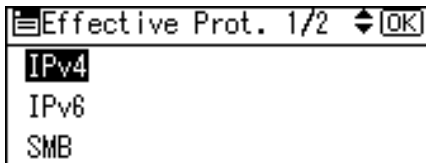

6. Press the [▼] or [▲] key to select [Active] or [Inactive], and then press the [OK] key.

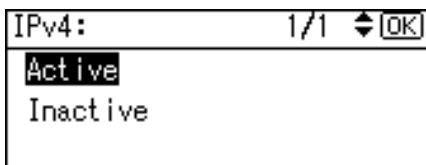

Set other protocols you need to set in the same way.

- Select [Inactive] for unused protocols.
- Enable IPv4 to use the pure IPv4 environment of NetWare5/5.1, NetWare 6/6.5.

7. Press the [Escape] key until the screen returns to the [Network] menu.
8. If you use IPv4, assign the IPv4 address to the printer. Press the [▼] or [▲] key to select [Machine IPv4 Address], and then press the [OK] key.

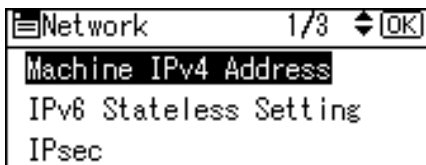

To get the IP address for the printer, consult your network administrator.

9. To specify the IP Address, press [IP Add.].

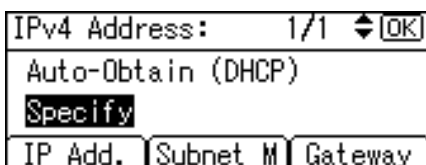

If you use IPv4, also assign the subnet mask and gateway address. To assign these, press [Subnet M] or [Gateway].

10. Press the number keys to enter the address, and then press the [OK] key.

Change the IP address from "11.22.33.44" to an IP address supported by your network.

11. Use the same method to assign the subnet mask and gateway address.
 12. Press the [▼] or [▲] key to select [Specify], and then press the [OK] key.

If you do not select [Specify] in this step, the address you set will not be saved.

13. Press the [Menu] key to return to the initial screen.
 14. Print a configuration page to confirm the settings.

↓ Note

- For details about printing the configuration page, see "Test Printing".

📖 Reference

- p.55 "Test Printing"

Receiving an IP Address Automatically (DHCP)

Follow this procedure to set the printer to receive an IP address automatically using DHCP. The DHCP feature is active by default, so this procedure is only required if you have changed the default settings.

★ Important

- When [Auto-Obtain (DHCP)] is selected, you cannot configure the IP address, subnet mask, or gateway address.
- Consult your network administrator for information about configuring network settings.

1. Press the [Menu] key.

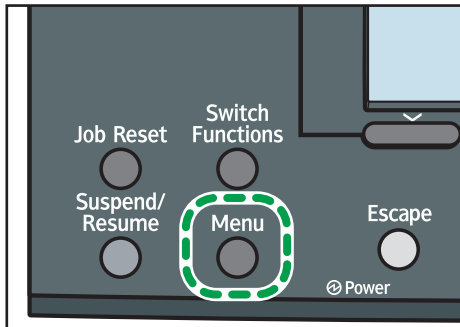

BYK087

2. Press the [▼] or [▲] key to select [Host Interface], and then press the [OK] key.

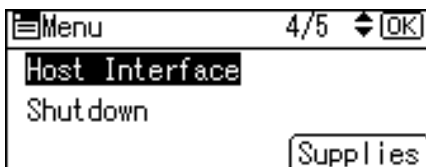

3. Press the [▼] or [▲] key to select [Network], and then press the [OK] key.

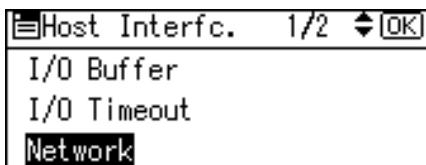

4. Press the [▼] or [▲] key to select [Machine IPv4 Address], and then press the [OK] key.

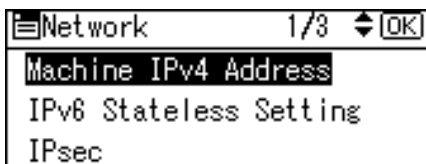

5. Press the [▼] or [▲] key to select [Auto-Obtain (DHCP)], and then press the [OK] key.

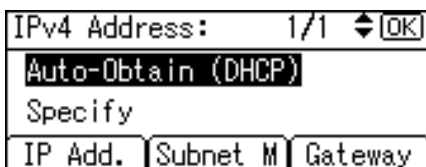

The printer will automatically receive an IP address.

To check the detected addresses, press the followings:

- [IP Add.]: IP address
- [Subnet M]: Subnet Mask

- [Gateway]: Default Gateway

6. Press the [Menu] key to return to the initial screen.

7. Print a configuration page to confirm the settings.

Note

- For details about printing the configuration page, see "Test Printing".

Reference

- p.55 "Test Printing"

Configuring Network Settings When Using NetWare

To use NetWare, select the appropriate NetWare frame type from the following.

5

- Auto Select
- Ethernet II
- Ethernet 802.2
- Ethernet 802.3
- Ethernet SNAP

Important

- Usually, you can use the default (Auto Select). When you first select [Auto Select], the frame type detected by the printer is adopted. However, if your network can use more than two frame types, the printer may fail to select the correct frame type with [Auto Select] selected. In this case, select the preferred frame type.

1. Press the [Menu] key.

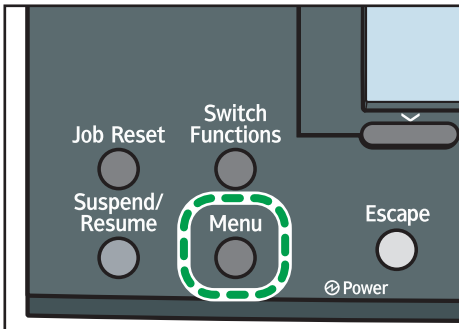

BYK087

- Press the [▼] or [▲] key to select [Host Interface], and then press the [OK] key.



- Press the [▼] or [▲] key to select [Network], and then press the [OK] key.

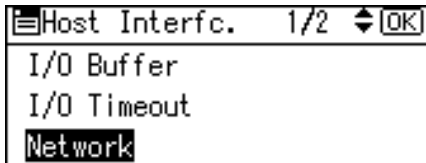

- Press the [▼] or [▲] key to select [NW Frame Type], and then press the [OK] key.

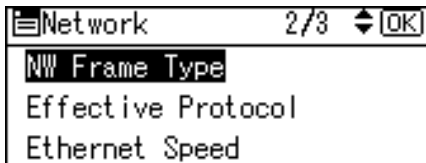

- Press the [▼] or [▲] key to select the frame type to use, and then press the [OK] key.

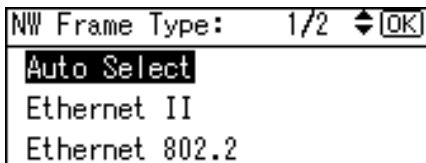

- Press the [Menu] key to return to the initial screen.
- Print a configuration page to confirm the settings.

↓ Note

- For details about printing the configuration page, see "Test Printing".

📖 Reference

- p.55 "Test Printing"

Setting the Ethernet Speed

You can set the speed that the printer will use for Ethernet communications. In most cases, this should be left on the default setting, [Auto Select]. This setting allows two interfaces to automatically determine the optimum speed when they are connected.

5

Router/HUB	Printer				
	[10Mbps Half Duplex]	[10Mbps Full Duplex]	[100Mbps Half Duplex]	[100Mbps Full Duplex]	[Auto Select]
10 Mbps half duplex	<input type="radio"/>	-	-	-	<input type="radio"/>
10 Mbps full duplex	-	<input type="radio"/>	-	-	-
100 Mbps half duplex	-	-	<input type="radio"/>	-	<input type="radio"/>
100 Mbps full duplex	-	-	-	<input type="radio"/>	-
auto-negotiation (auto selection)	<input type="radio"/>	-	<input type="radio"/>	-	<input type="radio"/>

★ Important

- Connection cannot be established if the selected Ethernet speed does not match your network's transmission speed.
- The use of this feature is recommended. To use it, select [Auto Select].

1. Press the [Menu] key.

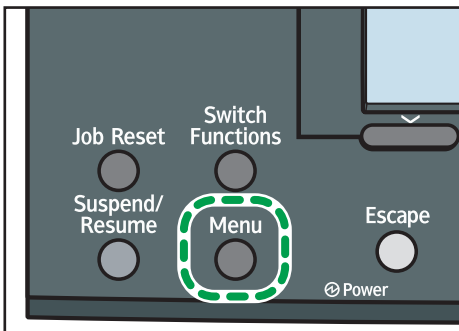

BYK087

- Press the [▼] or [▲] key to select [Host Interface], and then press the [OK] key.

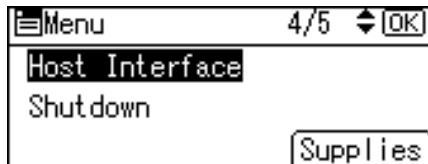

- Press the [▼] or [▲] key to select [Network], and then press the [OK] key.

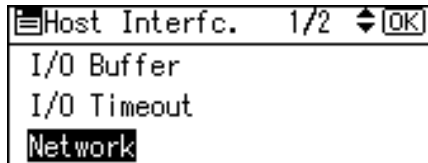

- Press the [▼] or [▲] key to select [Ethernet Speed], and then press the [OK] key.

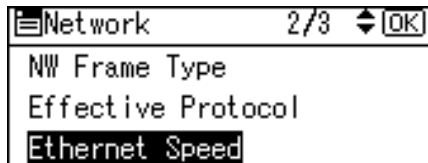

- Press the [▼] or [▲] key to select the Ethernet speed, and then press the [OK] key.

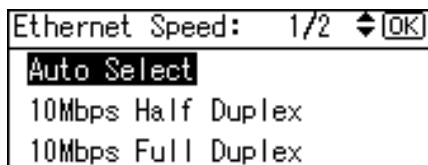

- Press the [Menu] key to return to the initial screen.
- Print a configuration page to confirm the settings.

↓ Note

- For details about printing the configuration page, see "Test Printing".

📖 Reference

- p.55 "Test Printing"

Enabling IEEE802.1X Authentication

Follow this procedure to enable IEEE802.1X Authentication.

★ Important

- To use IEEE802.1X Authentication, connect this machine to an authentication enabled port. If you do not, the authentication will fail.

1. Press the [Menu] key.

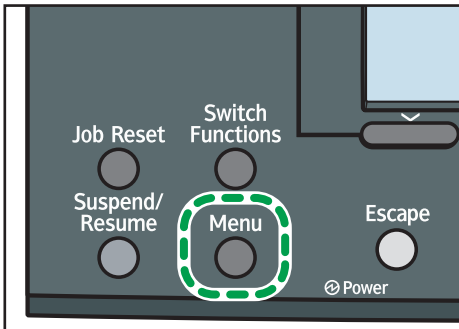

BYK087

2. Press the [▼] or [▲] key to select [Host Interface], and then press the [OK] key.



3. Press the [▼] or [▲] key to select [Network], and then press the [OK] key.

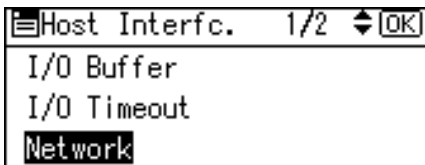

4. Press the [▼] or [▲] key to select [IEEE802.1X Auth.(Ethernet)], and then press the [OK] key.

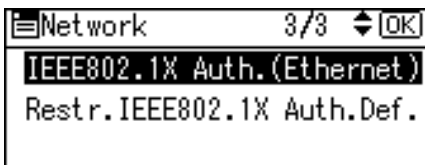

5. Press the [▼] or [▲] key to select [Active], and then press the [OK] key.

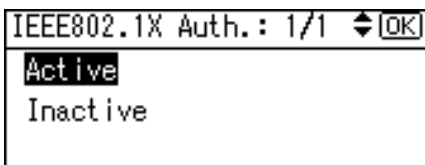

6. Press the [Menu] key to return to the initial screen.
7. Print a configuration page to confirm the settings.

Note

- For details about printing the configuration page, see "Test Printing".

Reference

- p.55 "Test Printing"

Wireless LAN Configuration

Configure the following wireless LAN settings according to the network environment using the control panel.

★ Important

- Ethernet and Wireless LAN cannot be used at the same time.
- To use wireless LAN, set as follows using the control panel: press the [Menu] key, select [Host Interface], [Network], [LAN Type], and then select [Wireless LAN]. In addition, you must set the IP address, subnet mask, gateway address, DHCP, Frame Type (NW), and active protocol as explained in "Ethernet Configuration".
- The following table shows the control panel settings and their defaults. These items appear in the [Host Interface] menu.

Setting Name	Default
Communication Mode	Infrastructure Mode
SSID Setting	blank
Ad-hoc Channel	11
Security Method	Off
Wireless LAN Signal	-
Restore Defaults	-

5

1. Press the [Menu] key.

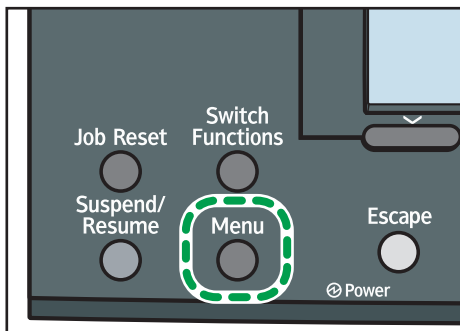

BYK087

- Press the [▼] or [▲] key to select [Host Interface], and then press the [OK] key.



- Press the [▼] or [▲] key to select [Wireless LAN], and then press the [OK] key.

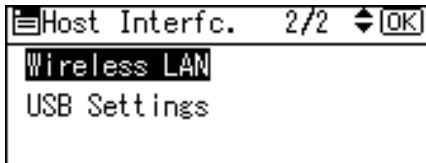

- Press the [▼] or [▲] key to select [Communication Mode], and then press the [OK] key.

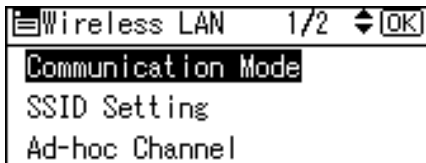

- Press the [▼] or [▲] key to select the transmission mode of Wireless LAN, and then press the [OK] key.

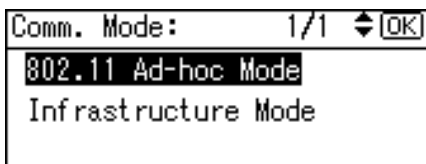

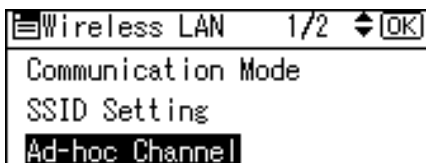

- To communicate wirelessly with a device that does not require an SSID to be set, select [802.11 Ad-hoc Mode].
 - The transmission mode of the wireless LAN can also be set using Web Image Monitor.
- If [802.11 Ad-hoc Mode] is selected for [Communication Mode], confirm the channel to use for transmission.
 - Press the [▼] or [▲] key to select [Ad-hoc Channel], and then press the [OK] key.



8. Press the scroll keys to select the Ad-hoc channel, and then press the [OK] key.

Ad-hoc Channel : 1/2					[OK]
1	2	3	4	5	
6	7	8	9	10	
11	12	13	36	40	

Select an Ad-hoc channel according to the IEEE 802.11 standard you are using.

- When using IEEE 802.11 b/g:
 -  **Region A** (mainly Europe and Asia)
Channels 1 to 13
 -  **Region B** (mainly North America)
Channels 1 to 11
- When using IEEE 802.11 a:
Channels 36,40,44,48

9. Press the [Menu] key to return to the initial screen.

10. Print a configuration page to confirm the settings.

Note

- For details, see Web Image Monitor Help, and "Using Web Image Monitor", Software Guide.
- For details about printing the configuration page, see "Test Printing".

Reference

- p.55 "Test Printing"
- p.93 "Ethernet Configuration"

Setting the SSID

When [Communication Mode] is set to [Infrastructure Mode] or [802.11 Ad-hoc Mode], you must specify the Service Set Identifier (SSID) of the wireless access point that the printer will connect to for network access.

Ask your network administrator for the SSID to use.

1. In the [Wireless LAN] menu, press the [▼] or [▲] key to select [SSID Setting], and then press the [OK] key.

Wireless LAN		1/2	[OK]
Communication Mode			
SSID Setting			
Ad-hoc Channel			

If an SSID has been set, you can check the current SSID setting.

2. Press [SSID], and then press [Enter].

SSID Setting:	1/1	◀▶	[OK]
SSID			

3. Press the number keys to enter characters, and then press the [OK] key.

SSID Setting:	[OK]
Enter SSID.	
abc	
ab/AB/12	Symbols

You can switch among lower /upper cases and numeric characters by pressing [ab/AB/12].

The characters that can be used are ASCII 0 × 20-0 × 7e (32 bytes).

4. Press the [Menu] key to return to the initial screen.
5. Print a configuration page to confirm the settings.

↓ Note

- The SSID can also be set using a Web browser. For details, see the Web Image Monitor Help.
- For details about printing the configuration page, see "Test Printing".

📖 Reference

- p.55 "Test Printing"

Confirming Wireless Network Connectivity

After you have installed the wireless LAN interface unit, use the following procedure to check for wireless LAN connectivity.

Make sure the LED on the wireless LAN interface unit is lit.

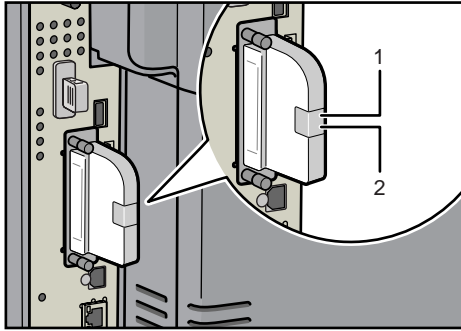

1. If the printer is connected to an operational network and is communicating normally, the lower indicator will be lit orange.
2. If the wireless LAN unit is receiving power, the upper indicator will be lit green.

5

Cautions When Using a Wireless LAN

A wireless LAN uses radio waves instead of cables to send and receive data. Because radio waves usually pass through walls and other obstructions, the following problems may arise if you do not configure wireless security settings.

Information leakage

Information such as IDs, passwords, credit card numbers, and e-mail content may be seen by an unauthorized 3rd party.

Unauthorized network access

- Damage to or alteration of data and/or system configurations by viruses or other malware.
- Impersonation of legitimate network users, resulting in data theft.
- Theft of sensitive or confidential data.

To minimize the possibility of these threats, it is recommended that you check the available features of this printer, wireless access points, and other equipment that uses the wireless LAN, and configure security settings for the wireless LAN.

Setting Security Method of Wireless LAN

Setting a WEP Key

If the wireless network uses WEP to encrypt transmitted data, the corresponding WEP key must be set to the printer to allow communications with other network devices.

Ask your network administrator for the WEP key to use.

1. Press the [Menu] key.

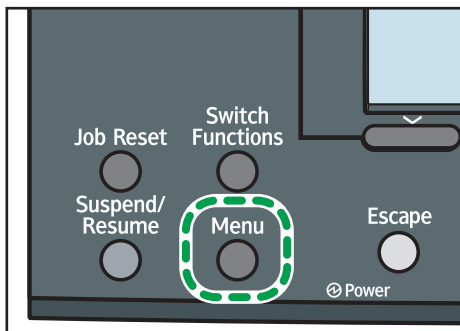

BYK087

2. Press the [▼] or [▲] key to select [Host Interface], and then press the [OK] key.

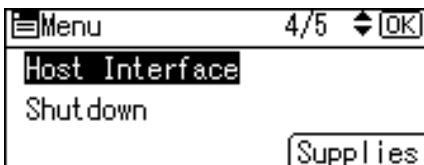

3. Press the [▼] or [▲] key to select [Wireless LAN], and then press the [OK] key.

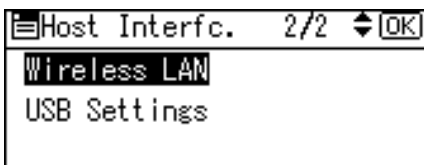

4. Press the [▼] or [▲] key to select [Security Method], and then press the [OK] key.

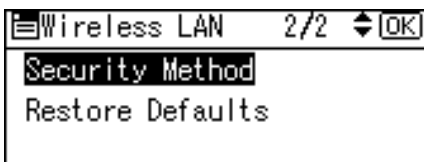

5. Press the [▼] or [▲] key to select [WEP], and then press [Details].

Security Method: 1/2		[OK]
Off		
WEP		
Details		

When activating the WEP setting, you will need to enter the WEP key. If you have not entered the key, be sure to enter it.

6. Press the scroll keys to enter characters, and then press the [OK] key.

WEP (Encryption) Key:		[OK]
Hex:10/26,ASCII:5/13 Digits		
abc		
ab/AB/12		Symbols

- When entering a character, pressing the [OK] key will mask it with an asterisk for security reasons.
- When using 64-bit WEP, up to 10 hexadecimal characters or five ASCII characters can be entered. When using 128-bit WEP, up to 26 hexadecimal characters or 13 ASCII characters can be used.
- Up to 10 or 26 hexadecimal characters and 5 or 13 ASCII characters can be entered.
- For ASCII character strings, uppercase and lowercase letters are differentiated, so be sure to enter characters in the required case.

7. Press the [▼] or [▲] key to select [WEP], and then press the [OK] key.

8. Press the [Menu] key to return to the initial screen.

9. Print a configuration page to confirm the settings.

↓ Note

- The WEP key can also be set using a Web browser. For details, see the Web Image Monitor Help.
- For details about printing the configuration page, see "Test Printing".

📖 Reference

- p.55 "Test Printing"

Setting WPA

In the case of using WPA on a network, activate the WPA setting to be used for communication along with WPA. Consult your network administrator for information about making authentication settings.

★ Important

- WPA is available for Type 1 model only if the optional HDD is installed.

1. Press the [Menu] key.

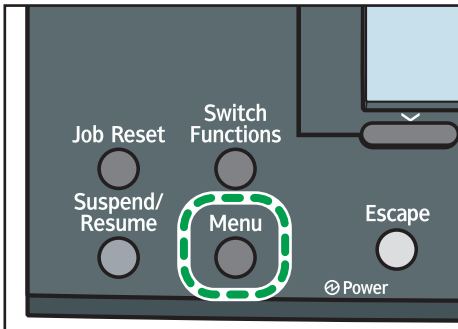

2. Press the [▼] or [▲] key to select [Host Interface], and then press the [OK] key.



3. Press the [▼] or [▲] key to select [Wireless LAN], and then press the [OK] key.

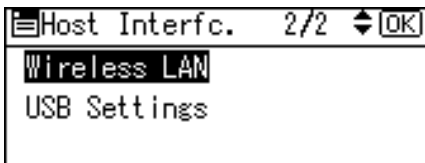

4. Press the [▼] or [▲] key to select [Security Method], and then press the [OK] key.

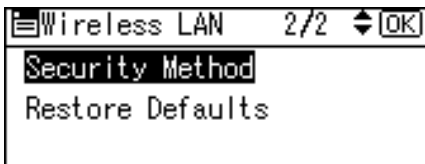

5. Press the [▼] or [▲] key to select [WPA], and then press [Details].

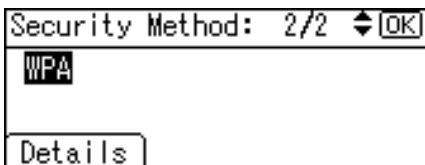

6. Press the [▼] or [▲] key to select [Encryption Method], and then press the [OK] key.

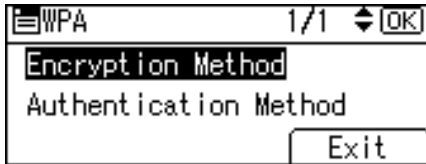

7. Press the [▼] or [▲] key to select encryption method, and then press the [OK] key.

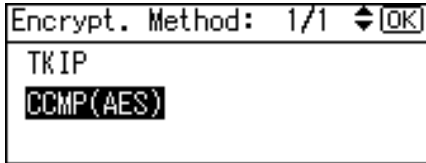

Consult your network administrator for information about making encryption settings.

Encryption settings are as follows:

- [TKIP]
 - Uses the same algorithm as RC4, but further reduces vulnerability using methods such as key mixing.
- [CCMP(AES)]
 - Increases security using AES (Advanced Encryption Standard).

The display returns to the [WPA] menu.

8. Press the [▼] or [▲] key to select [Authentication Method], and then press the [OK] key.

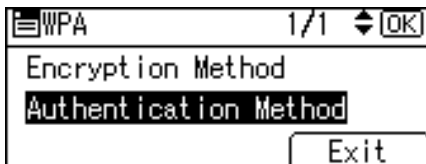

9. Press the [▼] or [▲] key to select authentication settings, and then press the [OK] key.

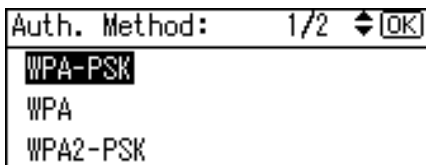

Authentication settings are as follows:

- [WPA-PSK]
 - Performs authentication using an encryption key (a Pre-Shared Key) that is shared by the access point and client.
- [WPA]

WPA uses CA certificates and a RADIUS server to provide secure wireless communication.

- [WPA2-PSK]

As with WPA-PSK, authenticate using the encryption key (a Pre-Shared Key) shared by the access point and client. Enter Pre-Shared Key using between 8 and 63 ASCII characters.

- [WPA2]

WPA2 is an expanded version of WPA that fully supports IEEE 802.11i.

Wait for two seconds, the display returns to the [WPA] menu.

10. If [WPA] or [WPA2] is selected in step 9, a confirmation message appears. Press [OK].

Wait for two seconds. The display returns to the [WPA] menu, proceed to step 15.

11. If [WPA-PSK] or [WPA2-PSK] is selected in step 9, a confirmation message appears. Press [OK].

12. Press the number keys to enter the Pre-Shared Key, and then press the [OK] key.

PSK Entry:		[OK]
Enter ASCII 8-63byte		
abc		
ab/AB/12		Symbols

- When entering a character, pressing [OK] will mask it with an asterisk for security reasons.
- Enter the Pre-Shared Key using between 8 and 63 ASCII characters.
- Uppercase and lowercase letters are differentiated, so be sure to enter characters in the required case.

13. When all characters have been entered, press the [OK] key.

PSK Entry:		[OK]
Enter ASCII 8-63byte		
abc	****_	
ab/AB/12		Symbols

Wait for two seconds. The display returns to the [Authentication Method] menu.

14. Press the [Escape] key.

15. Press [Exit].

WPA	1/1	[OK]
Encryption Method		
Authentication Method		
		Exit

16. Press the [▼] or [▲] key to select [WPA], and then press the [OK] key.

17. Press the [Menu] key to return to the initial screen.

18. Print a configuration page to confirm the settings.

↓ Note

- For details about printing the configuration page, see "Test Printing".

📖 Reference

- p.55 "Test Printing"

Configuring IEEE 802.1X

WPA/WPA2 uses an authentication server to provide greatly enhanced security compared to WPA-PSK/WPA2-PSK.

IEEE 802.1X (WPA/WPA2) can be configured using Web Image Monitor's administrator mode.

To configure the settings when using Ethernet; select [Host Interface] and [IEEE802.1X Auth.(Ethernet)] in [Network] on the display, and then select [Active].

To configure the settings when using a wireless LAN; configure WPA using the control panel or Web Image Monitor.

Important

- To set WPA/WPA2 for the wireless LAN, you must enable SSL.
- To set WPA/WPA2 for the wireless LAN, you must use Web Image Monitor.

Installing a Site Certificate

1. Access the authentication server and obtain the CA certificate.

Methods of obtaining certificates differ according to the operating system you are using.

2. Start your Web browser.
3. Enter "http://(printer's IP address)/" in the address bar of a Web browser.
4. Enter your user name and password, and then click [Login].

For details about the login user name and password, consult your network administrator.

5. Click [Configuration].
6. Click [Site Certificate] in the "Security" area.
7. Click [Browse] on the "Site Certificate to Import" window, and then select the CA certificate you obtained.
8. Click [Import].
9. Click [OK].
10. Click [Logout].
11. Quit the Web browser.

Installing Device Certificate

Depending on the settings of your choice, certain steps in the following procedure may not be required.

1. Start your Web browser.

2. Enter "http://(printer's IP address)/" in the address bar of a Web browser.
3. Enter your user name and password, and then click [Login].
For details about the login user name and password, consult your network administrator.
4. Click [Configuration].
5. Click [Device Certificate] in "Security" area.
6. Check [Certificate 2] on the "Device Certificate" window, and then click [Request].
7. Enter appropriate "Common Name" and "Country Code" on "Certificate Information" page, and then click [OK].
8. "Updating..." appears. Wait for about 2 minutes, and then click [OK].
9. Click [Details], shown in the "Device Certificate" window as the memo pad icon for "Requesting".
10. Select all, and then copy the entire "Text for Requested Certificate" text that is displayed in the "Certificate Status" window.
11. Access the certificate authority server, and then obtain the CA signified certificate using the text copied into "Text for Requested Certificate" windows.
Obtaining the certificate differs depending on the environment you want to use.
12. Click [Certificate 2] on "Device Certificate" window, and then click [Install].
13. Using a text editor, open the CA signified certificate downloaded in step 11, and then copy over all the text.
14. In the [Enter Certificate Request] window, paste all the text copied into the CA signified certificate.
15. Click [OK].
16. "Updating..." appears. Wait for about one or two minutes, and then click [OK].
Check that the "Device Certificate" shows "Installed".
17. Click [Certificate 2] on "Certification", and then click [OK].
18. Click [Logout].
19. Quit the Web browser.

Note

- You can select any Certificate between 1 and 4 in the "Device Certificate" window. Be sure to select the same Certificate number in both the "Device Certificate" window and the "Certification".
- If you request two certificates simultaneously, the certificate authority might not display either certificate. Click [Cancel Request] to cancel the request.
- Click [Cancel Request] to cancel the request for the server certificate.
- If "Not found" appears after clicking [OK] in steps 8 and 16, wait one or two minutes, and then click [Refresh].

Setting Items of WPA/WPA2

1. Start your Web browser.
2. Enter "http://(printer's IP address)/" in the address bar of a Web browser.
3. Enter your user name and password, and then click [Login].
For details about the login user name and password, consult your network administrator.
4. Click [Configuration], and then click [Wireless LAN Settings] in the "Interface" area.
5. Select [Infrastructure Mode] in "Communication Mode".
6. Enter the alphanumeric characters (a-z, A-Z, or 0-9) in [SSID] according to the access point you want to use.
7. Select [WPA] in "Security Method".
8. Select [TKIP] or [CCMP (AES)] in "WPA Encryption Method" according to the access point you want to use.
9. Select [WPA] or [WPA2] in "WPA Authentication Method".
10. Click [OK].
11. Click [Logout].
12. Quit the Web browser.

↓ Note

- You can select [Certificate 1] or [Certificate 2] in the "Device Certificate" window. Note that if you select [Certificate 1] in the "Device Certificate" window, you must select [Certificate 1] in the "IEEE 802.11a" list in the "Certification" window.
- If there is a problem with settings, you might not be able to communicate with the printer. To identify the problem, print a network summary.
- If you cannot identify the problem, reset the printer interface to normal, and then repeat the procedure from the beginning.

6. Paper and Other Media

This chapter explains the paper sizes and types supported by this printer, and how to load paper into the paper trays.

Supported Paper for Each Tray

This section describes the paper size, feed direction, and the maximum amount of paper that can be loaded into each paper tray in this printer.

Symbols

In this manual	On the display	Paper feed direction
☐↑ (Feed direction)	A4☐ 8 1/2" × 11☐	Short-edge feed direction



↓ Note

- Be careful of the paper feed direction when loading paper. The direction is determined for each paper size.
- If you want to change the default setting, contact your sales or service representative.



Standard Paper Feed Tray and optional paper feed trays

Standard paper feed tray

Automatically selected paper sizes

Model type	Paper sizes
 Region A	A4☐, A5☐, A6☐, 8 1/2" × 14" (Legal)☐, 8 1/2" × 11" (Letter)☐, 7 1/4" × 10 1/2" (Executive)☐
 Region B	8 1/2" × 14" (Legal)☐, 8 1/2" × 11" (Letter)☐, 7 1/4" × 10 1/2" (Executive)☐, 5 1/2" × 8 1/2"☐ (Half Letter), A4☐

Paper sizes requiring manual setting

Model type	Paper sizes
 Region A	B5 JIS, B6 JIS, 8 1/2" × 13" (Foolscap), 8 1/4" × 13" (Folio), 8" × 13" (F/GL), 5 1/2" × 8 1/2" (Half Letter), 4 1/8" × 9 1/2" (Com10), 3 7/8" × 7 1/2" (Monarch), C5 Env., C6 Env., DL Env., 16K
 Region B	A5, B5 JIS, A6, B6 JIS, 8 1/2" × 13" (Foolscap), 8 1/4" × 13" (Folio), 8" × 13" (F/GL), 4 1/8" × 9 1/2" (Com10), 3 7/8" × 7 1/2" (Monarch), C5 Env., C6 Env., DL Env., 16K



Tray 1 supports custom size paper, approximately 98 - 216 mm (3.86 - 8.5 inches) in width, and 148 - 355.5 mm (5.83 - 13.99 inches) in length. Set as custom size using the control panel and printer driver.

The supported size may differ depending on the printer language you use.

6

Optional paper feed trays

Automatically selected paper sizes

Model type	Paper sizes
 Region A	A4, A5, A6, 8 1/2" × 14" (Legal), 8 1/2" × 11" (Letter), 7 1/4" × 10 1/2" (Executive)
 Region B	8 1/2" × 14" (Legal), 8 1/2" × 11" (Letter), 7 1/4" × 10 1/2" (Executive), 5 1/2" × 8 1/2" (Half Letter), A4

Paper sizes requiring manual setting

Model type	Paper sizes
 Region A	B5 JIS, B6 JIS, 8 1/2" × 13" (Foolscap), 8 1/4" × 13" (Folio), 8" × 13" (F/GL), 5 1/2" × 8 1/2" (Half Letter), 4 1/8" × 9 1/2" (Com10), 3 7/8" × 7 1/2" (Monarch), C5 Env., C6 Env., DL Env., 16K

Model type	Paper sizes
	A5, B5 JIS, A6, B6 JIS, 8 1/2" × 13" (Foolscap), 8 1/4" × 13" (Folio), 8" × 13" (F/GL), 4 1/8" × 9 1/2" (Com10), 3 7/8" × 7 1/2" (Monarch), C5 Env., C6 Env., DL Env., 16K

Tray 2, Tray 3, and Tray 4 supports custom size paper, approximately 98 - 216 mm (3.86 - 8.5 inches) in width, and 148 - 355.5 mm (5.83 - 13.99 inches) in length.

Reference

- p.138 "Loading Paper"

Bypass Tray

Paper sizes requiring manual setting

The following sizes are supported, but they must be selected using the control panel. For details about paper size settings, see "Specifying standard size paper for the bypass tray".

The custom size must be selected using the control panel or the printer driver. For details about setting the paper size on the control panel, see "Specifying custom size paper for the bypass tray".

For details about setting on the printer driver, see the printer driver Help.

Paper sizes
A4, B5 JIS, A5, B6 JIS, A6, 8 1/2" × 14" (Legal), 8 1/2" × 13" (Foolscap), 8 1/2" × 11" (Letter), 8 1/4" × 13" (Folio), 8" × 13" (F/GL), 7 1/4" × 10 1/2" (Executive), 5 1/2" × 8 1/2" (Half Letter), 4 1/8" × 9 1/2" (Com10), 3 7/8" × 7 1/2" (Monarch), C5 Env., C6 Env., DL Env., 16K

Bypass Tray supports custom size paper, approximately 70 - 216 mm (2.76 - 8.5 inches) in width, and 127 - 1260 mm (5 - 49.6 inches) in length. Set as custom size using the printer driver.

The supported size may differ depending on the printer language you use.

Reference

- p.147 "Specifying standard size paper for the bypass tray"
- p.149 "Specifying custom size paper for the bypass tray"

Paper Weight and Capacity

Tray	Supported paper weight	Supported capacity (Plain paper)
Tray 1	52 to 220 g/m ² (14 to 59 lb.)	550 sheets (80 g/m ² , 20 lb.)
Tray 2, Tray 3, Tray4	52 to 220 g/m ² (14 to 59 lb.)	550 sheets (80 g/m ² , 20 lb.)
Bypass tray	52 to 256 g/m ² (14 to 68 lb.)	100 sheets (80 g/m ² , 20 lb.)

Note

- Do not load the paper so that the top of the stack exceeds the under limit mark inside the tray.

Paper Recommendations

This section describes loading and storing paper, details of each type of paper, and the printable area. Configure the settings depending on the type of paper you are using.

★ Important

- **Print quality cannot always be guaranteed for all types of paper that are sold at stores.**

Storing Paper

Take care when storing paper. Improperly stored paper might result in poor print quality, paper misfeeds, or printer damage. Recommendations are as follows:

- Avoid storing paper in humid areas.
- Avoid exposing paper to direct sunlight.
- Store on a flat surface.
- Keep paper in its original package until time to use it.

6

Types of Paper and Other Media

This section describes the types of paper and the settings they require.

Plain paper

Paper thickness	61 to 90 g/m ² (16 to 24 lb.)
Printer setup	Press the [Menu] key, select [Paper Input], [Paper Type: (tray name)], and then select [No Display (Plain Paper)].
Printer driver setup	Click [Plain & Recycled] or [Plain (81 to 90 g/m ²)] in the "Paper Type:" list.
Supported paper feed tray	Any input tray can be used.
Paper capacity	<ul style="list-style-type: none"> • Tray 1: 550 • Tray 2, Tray 3, Tray 4 (Paper feed unit): 550 • Bypass Tray: 100 <p>Make sure paper is not stacked higher than the upper limit mark (▼) inside the tray. When using the bypass tray, make sure paper is not stacked higher than the paper guides on the bypass tray.</p>

Duplex printing	Supported
Maintenance	<ul style="list-style-type: none"> [Plain Paper 1]: 61 to 80 g/m² (16 to 21 lb.) [Plain Paper 2]: 81 to 90 g/m² (22 to 24 lb.) <p>Default: [Plain Paper 2]</p> <p>If prints made using the paper tray show heavy smudging, use the following procedure to change the paper type setting from the control panel:</p> <ul style="list-style-type: none"> Press the [Menu] key, select [Maintenance], [General Settings], and then select [Plain Paper Setting]. Select the paper tray, and then select [Plain Paper 1] or [Plain Paper 2]. <p>When specifying paper thickness, remember that a higher number indicates greater thickness. Also, because the paper thickness will normally be detected automatically, change this setting only if a print problem occurs.</p>

6

Middle thick

Paper thickness	91 to 105 g/m ² (24 to 28 lb.)
Printer setup	Press the [Menu] key, select [Paper Input], [Paper Type: (tray name)], and then select [Middle Thick].
Printer driver setup	Click [Middle Thick (91 to 105 g/m ²)] in the "Paper Type:" list.
Supported paper feed tray	Any input tray can be used. Make sure paper is not stacked higher than the upper limit mark (▼) inside the tray. When using the bypass tray, make sure paper is not stacked higher than the paper guides on the bypass tray.
Duplex printing	Supported
Additional cautions	Printing may be slower than when using plain paper.

Thick paper

Paper thickness	<p>106 to 256 g/m² (28 to 68 lb.)</p> <ul style="list-style-type: none"> • [Thick Paper 1]: 106 to 130 g/m² (28 to 35 lb.) • [Thick Paper 2]: 131 to 163 g/m² (35 to 43 lb.) • [Thick Paper 3]: 164 to 220 g/m² (44 to 59 lb.) • [Thick Paper 4]: 221 to 256 g/m² (59 to 68 lb.)
Printer setup	<ul style="list-style-type: none"> • Press the [Menu] key, select [Paper Input], [Paper Type: (tray name)], and then select [Thick Paper 1], [Thick Paper 2] or [Thick Paper 3]. • Press the [Menu] key, select [Paper Input], [Paper Type: Bypass Tray], and then select [Thick Paper 4].
Printer driver setup	<ul style="list-style-type: none"> • [Thick Paper 1]: Click [Thick 1 (106 to 130 g/m²)] in the "Paper Type:" list. • [Thick Paper 2]: Click [Thick 2 (131 to 163 g/m²)] in the "Paper Type:" list. • [Thick Paper 3]: Click [Thick 3 (164 to 220 g/m²)] in the "Paper Type:" list. • [Thick Paper 4]: Click [Bypass Tray] in "Input Tray:" list, and then Click [Thick 4 (221 to 256 g/m²)] in the "Paper Type:" list.
Supported paper feed tray	<p>Any input tray can be used.</p> <p>Make sure paper is not stacked higher than the upper limit mark (▼) inside the tray. When using the bypass tray, make sure paper is not stacked higher than the paper guides on the bypass tray.</p>
Duplex printing	<ul style="list-style-type: none"> • [Thick Paper 1], [Thick Paper 2], : Supported • [Thick Paper 3], [Thick Paper 4]: Not supported
Additional cautions	Printing is slightly slower than when using plain paper.

Thin paper

Paper thickness	52 to 60.2 g/m ² (14 to 16 lb.)
Printer setup	Press the [Menu] key, select [Paper Input], [Paper Type: (tray name)], and then select [Thin Paper].

Printer driver setup	Click [Thin (52 to 60 g/m2)] in the "Paper Type:" list.
Supported paper feed tray	Any input tray can be used. Make sure paper is not stacked higher than the upper limit mark (▼) inside the tray. When using the bypass tray, make sure paper is not stacked higher than the paper guides on the bypass tray.
Duplex printing	Not supported

OHP transparencies

Printer setup	Press the [Menu] key, select [Paper Input], [Paper Type: Bypass Tray], and then select [OHP (Transparency)].
Printer driver setup	Click [Bypass Tray] in "Input Tray:" list, and then click [Transparency] in the "Paper Type:" list.
Supported paper feed tray	This paper type can be printed only from the bypass tray.
Paper capacity	<ul style="list-style-type: none"> • Bypass Tray: 100 Make sure paper is not stacked higher than the upper limit mark (▼) inside the tray. When using the bypass tray, make sure paper is not stacked higher than the paper guides on the bypass tray.
Duplex printing	Not supported
Additional cautions	<ul style="list-style-type: none"> • Printing is slightly slower than when using plain paper. • Due to switching modes, the printer will be on standby for thirty or forty seconds after the job was received. • We recommend that you use a 4000 ANSI lumen or brighter overhead projector to project OHP transparencies.

Letterhead

Printer setup	Press the [Menu] key, select [Paper Input], [Paper Type: (tray name)], and then select [Letterhead].
Printer driver setup	Click [Letterhead] in the "Paper Type:" list.

Supported paper feed tray	<p>Any input tray can be used.</p> <p>Make sure paper is not stacked higher than the upper limit mark (▼) inside the tray. When using the bypass tray, make sure paper is not stacked higher than the paper guides on the bypass tray.</p>
Duplex printing	Supported
Maintenance	<p>Default: [Letterhead 2]</p> <p>If prints made using the paper tray show heavy smudging, use the following procedure to change the paper type setting from the control panel:</p> <ul style="list-style-type: none"> • Press the [Menu] key, select [Maintenance], [General Settings], and then select [Letterhead Setting]. Select the paper tray, and then select one from [Letterhead 1], [Letterhead 2],[Letterhead 3], [Letterhead 4] or [Letterhead 5]. <p>When specifying paper thickness, remember that a higher number indicates greater thickness. Also, because the paper thickness will normally be detected automatically, change this setting only if a print problem occurs.</p>

Label paper

Printer setup	Press the [Menu] key, select [Paper Input], [Paper Type: (tray name)], and then select [Label Paper].
Printer driver setup	Click [Labels] in the "Paper Type:" list.
Supported paper feed tray	<p>Any input tray can be used.</p> <p>Make sure paper is not stacked higher than the upper limit mark (▼) inside the tray. When using the bypass tray, make sure paper is not stacked higher than the paper guides on the bypass tray.</p>
Duplex printing	Not supported

<p>Maintenance</p>	<p>Default: [Label Paper 6]</p> <p>If prints made using the paper tray show heavy smudging, use the following procedure to change the paper type setting from the control panel:</p> <ul style="list-style-type: none"> • Press the [Menu] key, select [Maintenance], [General Settings], and then select [Label Paper Setting]. Select the paper tray, and then select one from [Label Paper 1], [Label Paper 2], [Label Paper 3], [Label Paper 4], [Label Paper 5], or [Label Paper 6]. <p>When specifying paper thickness, remember that a higher number indicates greater thickness. Also, because the paper thickness will normally be detected automatically, change this setting only if a print problem occurs.</p>
--------------------	--

Coated Paper (Glossy)

6

<p>Printer setup</p>	<p>Press the [Menu] key, select [Paper Input], [Paper Type: (tray name)], and then select [Coated Paper (Glossy)].</p>
<p>Printer driver setup</p>	<p>Click [Coated (Glossy)] in the "Paper Type:" list.</p>
<p>Supported paper feed tray</p>	<p>Any input tray can be used.</p> <p>Make sure paper is not stacked higher than the upper limit mark (▼) inside the tray. When using the bypass tray, make sure paper is not stacked higher than the paper guides on the bypass tray.</p>
<p>Duplex printing</p>	<p>Supported</p>
<p>Maintenance</p>	<p>Default: [Coated Paper (Glossy) 4]</p> <p>If prints made using the paper tray show heavy smudging, use the following procedure to change the paper type setting from the control panel:</p> <ul style="list-style-type: none"> • Press the [Menu] key, select [Maintenance], [General Settings], and then select [Coated Paper (Glossy) Stg.]. Select the paper tray, and then select one from [Coated Paper (Glossy) 1], [Coated Paper (Glossy) 2], [Coated Paper (Glossy) 3], [Coated Paper (Glossy) 4], or [Coated Paper (Glossy) 5]. <p>When specifying paper thickness, remember that a higher number indicates greater thickness. Also, because the paper thickness will normally be detected automatically, change this setting only if a print problem occurs.</p>

Coated Paper (Glossy: Thick)

Printer setup	Press the [Menu] key, select [Paper Input], [Paper Type: (tray name)], and then select [Coated Paper(Glossy:Thick)].
Printer driver setup	Click [Coated (Glossy: Thick Paper)] in the "Paper Type:" list.
Supported paper feed tray	Any input tray can be used. Make sure paper is not stacked higher than the upper limit mark (▼) inside the tray. When using the bypass tray, make sure paper is not stacked higher than the paper guides on the bypass tray.
Duplex printing	Not supported
Maintenance	<p>Default: [CoatedPaper(Glossy:Thick)1]</p> <p>If prints made using the bypass tray show heavy smudging, use the following procedure to change the paper type setting from the control panel:</p> <ul style="list-style-type: none"> Press the [Menu] key, select [Maintenance], [General Settings], and then select [Coated Paper(Glossy:Thick)]. Select the bypass tray, and then select [CoatedPaper(Glossy:Thick)1] or [CoatedPaper(Glossy:Thick)2]. <p>Note that this setting cannot be changed if you are printing from Tray 1 to 4. You can change this setting only when printing from the bypass tray.</p> <p>When specifying paper thickness, remember that a higher number indicates greater thickness. Also, because the paper thickness will normally be detected automatically, change this setting only if a print problem occurs.</p>
Additional cautions	Printing is slightly slower than when using plain paper.

Coated Paper (Matted)

Printer setup	Press the [Menu] key, select [Paper Input], [Paper Type: (tray name)], and then select [Coated Paper (Matted)].
Printer driver setup	Click [Coated (Matted)] in the "Paper Type:" list.

Supported paper feed tray	<p>Any input tray can be used.</p> <p>Make sure paper is not stacked higher than the upper limit mark (▼) inside the tray. When using the bypass tray, make sure paper is not stacked higher than the paper guides on the bypass tray.</p>
Duplex printing	Supported
Maintenance	<p>Default: [Coated Paper (Matted) 4]</p> <p>If prints made using the paper tray show heavy smudging, use the following procedure to change the paper type setting from the control panel:</p> <ul style="list-style-type: none"> • Press the [Menu] key, select [Maintenance], [General Settings], and then select [Coated Paper (Matted) Stg.]. Select the paper tray, and then select one from [Coated Paper (Matted) 1], [Coated Paper (Matted) 2], [Coated Paper (Matted) 3], [Coated Paper (Matted) 4], or [Coated Paper (Matted) 5]. <p>When specifying paper thickness, remember that a higher number indicates greater thickness. Also, because the paper thickness will normally be detected automatically, change this setting only if a print problem occurs.</p>

Coated Paper (Matted: Thick)

Printer setup	Press the [Menu] key, select [Paper Input], [Paper Type: (tray name)], and then select [Coated Paper(Matted:Thick)].
Printer driver setup	Click [Coated (Matted: Thick Paper)] in the "Paper Type:" list.
Supported paper feed tray	<p>Any input tray can be used.</p> <p>Make sure paper is not stacked higher than the upper limit mark (▼) inside the tray. When using the bypass tray, make sure paper is not stacked higher than the paper guides on the bypass tray.</p>
Duplex printing	Not supported

Maintenance	<p>Default: [CoatedPaper(Matted:Thick)1]</p> <p>If prints made using the bypass tray show heavy smudging, use the following procedure to change the paper type setting from the control panel:</p> <ul style="list-style-type: none"> • Press the [Menu] key, select [Maintenance], [General Settings], and then select [Coated Paper(Matted:Thick)]. Select the bypass tray, and then select [CoatedPaper(Matted:Thick)1] or [CoatedPaper(Matted:Thick)2]. <p>Note that this setting cannot be changed if you are printing from Tray 1 to 4. You can change this setting only when printing from the bypass tray.</p> <p>When specifying paper thickness, remember that a higher number indicates greater thickness. Also, because the paper thickness will normally be detected automatically, change this setting only if a print problem occurs.</p>
Additional cautions	Printing is slightly slower than when using plain paper.

Waterproof Paper

Printer setup	Press the [Menu] key, select [Paper Input], [Paper Type: (tray name)], and then select [Waterproof Paper].
Printer driver setup	Click [Waterproof] in the "Paper Type:" list.
Supported paper feed tray	<p>Any input tray can be used.</p> <p>Make sure paper is not stacked higher than the upper limit mark (▼) inside the tray. When using the bypass tray, make sure paper is not stacked higher than the paper guides on the bypass tray.</p>
Duplex printing	Not supported

Maintenance	<p>Default: [Waterproof Paper 5]</p> <p>If prints made using the paper tray show heavy smudging, use the following procedure to change the paper type setting from the control panel:</p> <ul style="list-style-type: none"> • Press the [Menu] key, select [Maintenance], [General Settings], and then select [Waterproof Paper Setting]. Select the paper tray, and then select one from [Waterproof Paper 1], [Waterproof Paper 2], [Waterproof Paper 3], [Waterproof Paper 4], or [Waterproof Paper 5]. <p>When specifying paper thickness, remember that a higher number indicates greater thickness. Also, because the paper thickness will normally be detected automatically, change this setting only if a print problem occurs.</p>
-------------	--

Special paper

6

Special paper standard	When you cannot print successfully with other paper type settings, set special paper.
Printer setup	Press the [Menu] key, select [Paper Input], [Paper Type: (tray name)], and then select [Special Paper 1], [Special Paper 2], or [Special Paper 3].
Printer driver setup	Click [Special 1],[Special 2], or [Special 3] in the "Paper Type:" list.
Supported paper feed tray	Any input tray can be used. Make sure paper is not stacked higher than the upper limit mark (▼) inside the tray. When using the bypass tray, make sure paper is not stacked higher than the paper guides on the bypass tray.
Duplex printing	Supported

Preprinted paper

Printer setup	Press the [Menu] key, select [Paper Input], [Paper Type: (tray name)], and then select [Preprinted Paper].
Printer driver setup	Click [Preprinted] in the "Paper Type:" list.

Supported paper feed tray	Any input tray can be used. Make sure paper is not stacked higher than the upper limit mark (▼) inside the tray. When using the bypass tray, make sure paper is not stacked higher than the paper guides on the bypass tray.
Duplex printing	Not supported

Recycled paper

Printer setup	Press the [Menu] key, select [Paper Input], [Paper Type: (tray name)], and then select [Recycled Paper].
Printer driver setup	Click [Recycled] or [Plain & Recycled] in the "Paper Type:" list.
Supported paper feed tray	Any input tray can be used. Make sure paper is not stacked higher than the upper limit mark (▼) inside the tray. When using the bypass tray, make sure paper is not stacked higher than the paper guides on the bypass tray.
Duplex printing	Supported

Envelopes

Printer setup	Press the [Menu] key, select [Paper Input], [Paper Type: (tray name)], and then select [Envelope].
Printer driver setup	Click [Envelope], in the "Paper Type:" list.
Supported paper feed tray	Any input tray can be used. Make sure paper is not stacked higher than the upper limit mark (▼) inside the tray. When using the bypass tray, make sure paper is not stacked higher than the paper guides on the bypass tray.
Duplex printing	Not supported

Maintenance	<p>Default: [Envelope 1]</p> <p>If prints made using the paper tray show heavy smudging, use the following procedure to change the paper type setting from the control panel:</p> <ul style="list-style-type: none"> • Press the [Menu] key, select [Maintenance], [General Settings], and then select [Envelope Setting]. Select the paper tray, and then select one from [Envelope 1], [Envelope 2], [Envelope 3], or [Envelope 4]. <p>When specifying paper thickness, remember that a higher number indicates greater thickness. Also, because the paper thickness will normally be detected automatically, change this setting only if a print problem occurs.</p>
Additional cautions	<ul style="list-style-type: none"> • Check there is no air in the envelopes before loading. • For optimum print results, we recommend you set at least 15 mm (0.6 inches) for the left print margin, and at least 10 mm (0.4 inches) for the right, top, and bottom margins. • Load only one size and type of envelope at a time. • Before loading envelopes, flatten their leading edges (the edge going into the printer) by running a pencil or ruler across them. • Some kinds of envelope might cause misfeeds, wrinkles or print poorly. • Print quality on envelopes may be uneven if parts of an envelope have differing thicknesses. Print one or two envelopes to check print quality. • In a hot and humid environment, the envelope might be output creased or improper printing quality.

Note

- Load envelopes print side up in the standard paper feed tray or optional paper feed tray.
- Load envelopes with flaps closed to the left side of the tray.

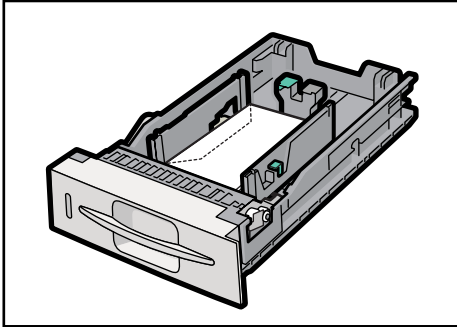

BYK096

- Load envelopes print side down on the bypass tray.
- Load envelopes with flaps closed to the left side of the tray.

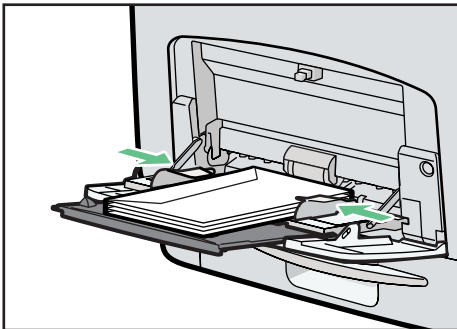

BYK095

Paper Not Supported by This Printer

★ Important

- Do not use the following types of paper:
 - Ink-jet printer paper
 - GelJet special paper
 - Bent, folded, or creased paper
 - Curled or twisted paper
 - Wet paper
 - Paper that is dry enough to emit static electricity
 - Paper that has already been printed on

Misprints are especially likely when using paper printed on by printers other than a laser printer (e.g. monochrome and color copiers, ink-jet printers, etc.) Refrain from printing on the side on which nothing is printed.

- Surface-processed paper (excluding specified paper)

- Special paper, such as thermal paper and carbon paper
- Paper whose weight is heavier or lighter than the limitation
- Perforated paper
- Adhesive label paper on which glue or base paper is exposed
- Paper with clips or staples

Note

- Even if paper is adequate for the printer, poorly stored paper can cause paper misfeeds, print quality degradation, or malfunctions.

Print Area

This section describes the area of a page that is available for printing.

The following diagram shows the print area for this printer.

Paper

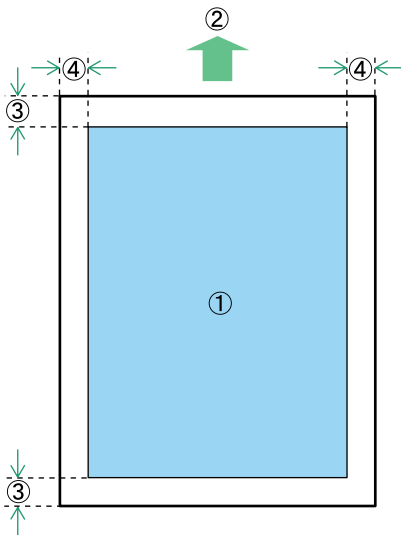

- ① Print area
- ② Feed direction
- ③ Approx. 4.2 mm (0.17 inches)
- ④ Approx. 4.2 mm (0.17 inches)

Note

- The print area may vary depending on the paper size, printer language and printer driver settings.

Envelope

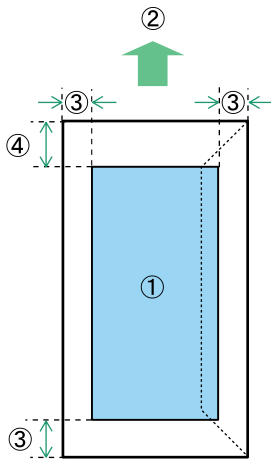

BYK124

- ① Print area
- ② Feed direction
- ③ Approx. 10 mm (0.4 inches)
- ④ Approx. 15 mm (0.6 inches)

↓ Note

- The print area may vary depending on the paper size, printer language and printer driver settings.

Loading Paper

This section describes how to load paper into the paper tray or onto the bypass tray.

Loading Paper into Standard Paper Feed Tray or Optional Paper Feed Trays

The following example explains loading procedure for the standard paper feed tray (Tray 1). The same procedure can be used for the optional paper feed tray. Tray 1 is used as an example.

★ Important

- Make sure paper is not stacked higher than the upper limit mark inside the paper tray. Paper misfeeds might occur.
- Do not mix different types of paper in the same paper tray.
- During printing, do not open or close the printer covers or bypass tray, or pull out or push in the paper tray.
- The default setting of tray 1 is as follows:
 - **Region A** (mainly Europe and Asia)
A4
 - **Region B** (mainly North America)
8 1/2 " × 11 " (Letter)

1. Slowly slide out the paper tray (Tray 1), until it stops. Then, lift the front of the tray slightly, and then pull the tray completely out.

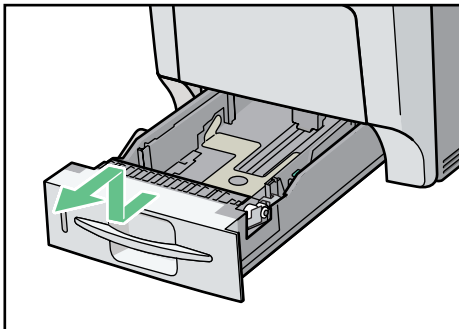

Place the tray on a flat surface.

2. Pinch the green clips on the side guide and the end guide, and then adjust the guides to the paper size being loaded.

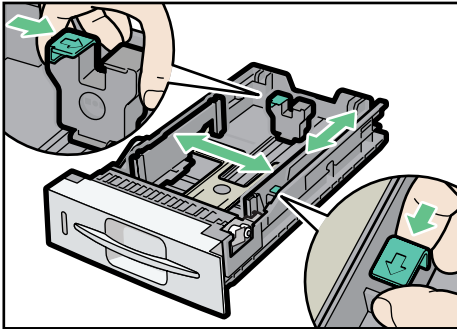

3. Fan the paper before loading paper in the tray.

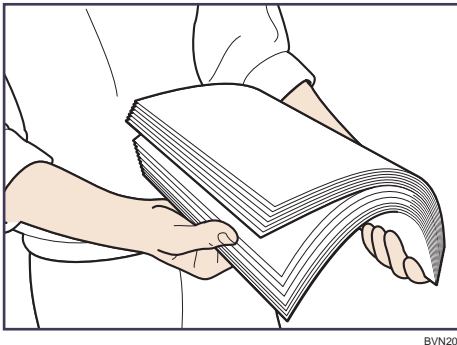

4. Load the new paper stack print side up, making sure the paper is flush against the paper guides.

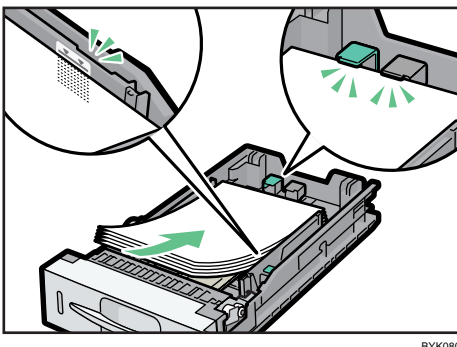

5. Adjust the paper guides to close any gaps.

Do not move paper loaded in the tray more than a few millimeters.

Excessive movement of loaded paper can cause edges of sheets to snag on the openings of the tray's lifting plate, resulting in sheets being folded or becoming jammed.

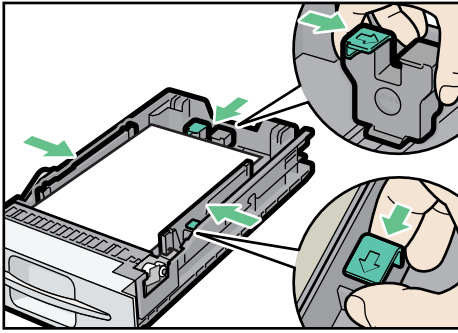

6. Lift the front of the paper tray (Tray 1), and slowly slide the paper tray back in, until it stops. Make sure the tray is fully inserted to prevent a paper misfeed.

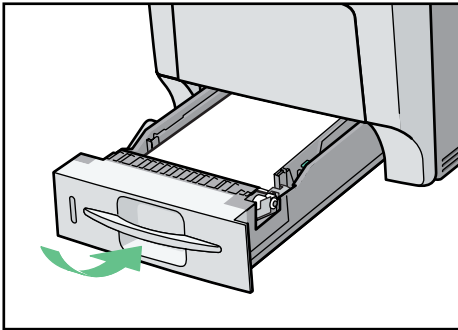

6

Note

- For details about paper types supported by the printer, see "Types of Paper and Other Media".

Reference

- p.123 "Types of Paper and Other Media"

Setting a paper size by using the control panel

To load paper whose size cannot be selected automatically, set the paper size on the control panel. Follow the procedure described below to set the paper size.

1. Press the [Menu] key.

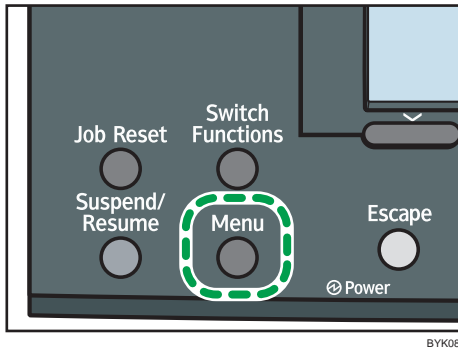

2. Press the [▼] or [▲] key to select [Paper Input], and then press the [OK] key.

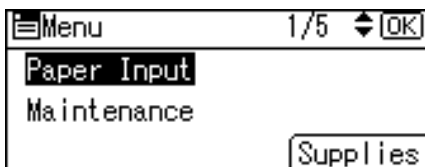

3. Press the [▼] or [▲] key to select [Paper Size: (tray name)], and then press the [OK] key.
In the illustration below, [Paper Size: Tray 1] is selected for Tray 1.



4. Select the paper size you want to set using the scroll keys, and then press the [OK] key.

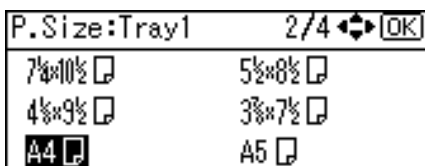

5. Press the [Menu] key to return to the initial screen.

Setting the paper size automatically

★ Important

- Use the following procedure if you have been specifying the paper size manually using the control panel and want to reapply automatic paper size detection.

1. Press the [Menu] key.

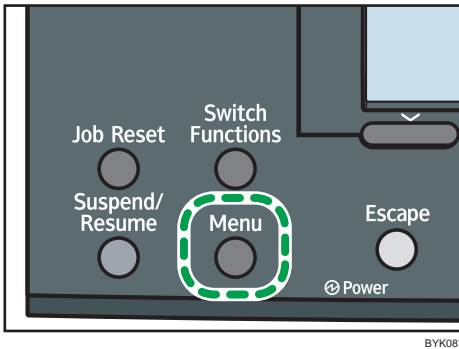

2. Press the [▼] or [▲] key to select [Paper Input], and then press the [OK] key.

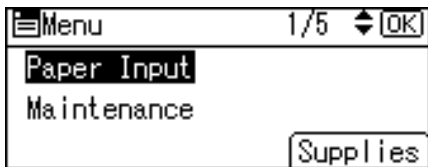

3. Press the [▼] or [▲] key to select [Paper Size: (tray name)], and then press the [OK] key.
In the illustration below, [Paper Size: Tray 1] is selected for Tray 1.

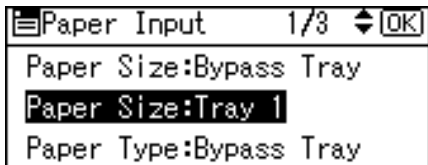

4. Select [Auto Detect] using the scroll keys, and then press the [OK] key.

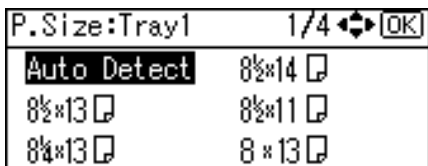

5. Press the [Menu] key to return to the initial screen.

Note

- For details about the available paper size, see "Supported Paper for Each Tray".

Reference

- p.119 "Supported Paper for Each Tray"

Specifying custom size paper for standard paper feed tray and optional paper feed tray

This section describes how to load custom size paper into trays 1 to 4.

★ Important

- When printing on custom size paper, specify the paper size using the control panel or printer driver.
- The standard paper tray (Tray 1) and the optional paper feed units (Tray 2, 3, and 4) can accommodate paper that is 98 - 216 mm (3.86 - 8.5 inches) wide and 148 - 355.5 mm (5.83 - 13.99 inches) long. You cannot load these trays with paper that is outside this size range.
- The printer cannot print from applications that do not support custom size paper.

1. Press the [Menu] key.

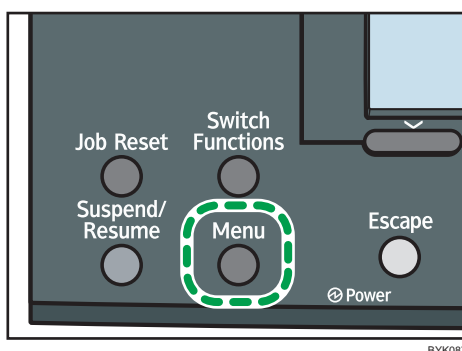

2. Press the [▼] or [▲] key to select [Paper Input], and then press the [OK] key.

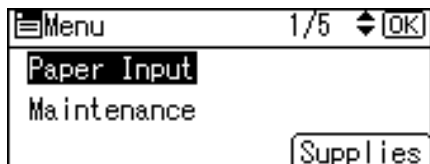

3. Press the [▼] or [▲] key to select [Paper Size: (tray name)], and then press the [OK] key.
In the illustration below, [Paper Size: Tray 1] is selected for Tray 1.



4. Press the [▼] or [▲] key to select [Custom Size], and then press the [OK] key.

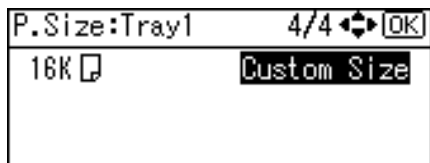

5. Press the number keys to enter the horizontal value, and then press the [OK] key.

Region **A** (mainly Europe and Asia)

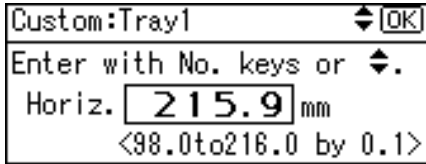

Region **B** (mainly North America)

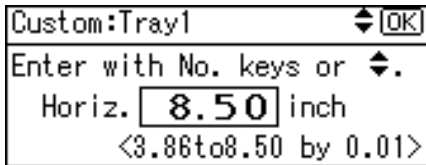

6. Press the number keys to enter the vertical value, and then press the [OK] key.

Region **A** (mainly Europe and Asia)

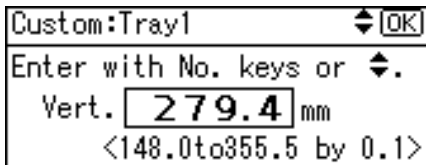

Region **B** (mainly North America)

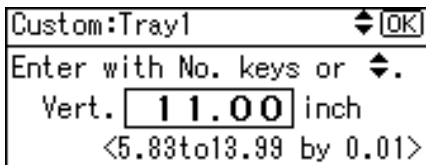

7. Press the [Menu] key to return to the initial screen.

Specifying a paper type for standard paper feed tray and optional paper feed tray

This section describes how to specify a paper type. You can improve printer performance by selecting the optimum paper type for the tray. You can select from the following paper types:

- No Display (Plain Paper), Middle Thick, Thick Paper 1, Thick Paper 2, Thick Paper 3, Thin Paper, Letterhead, Label Paper, Coated Paper (Glossy), CoatedPaper(Glossy:Thick), Coated Paper (Matted), CoatedPaper(Matted:Thick), Waterproof Paper, Special Paper 1, Special Paper 2, Special Paper 3, Preprinted Paper, Recycled Paper, Envelope

1. Press the [Menu] key.

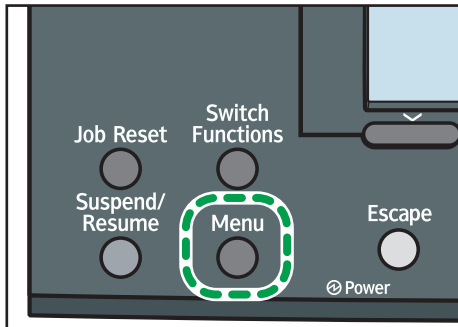

BYK087

2. Press the [▼] or [▲] key to select [Paper Input], and then press the [OK] key.

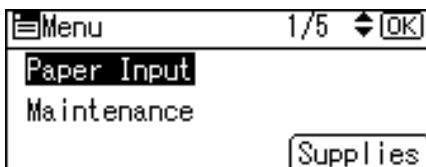

3. Press the [▼] or [▲] key to select [Paper Type: (tray name)], and then press the [OK] key.
In the illustration below, [Paper Type: Tray 1] is selected for Tray 1.

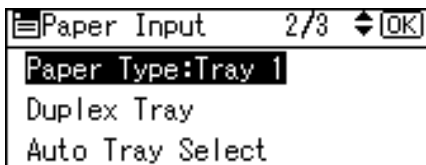

4. Press the [▼] or [▲] key to select the paper type that is loaded, and then press the [OK] key.

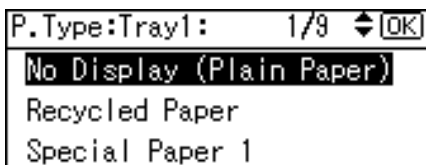

About two seconds later, the display returns to the Paper Input screen.

5. Press the [Menu] key to return to the initial screen.

↓ Note

- If the printing result is badly smudged, change the setting on the printer's control panel. For details, see "Types of Paper and Other Media".
- The following paper types cannot be printed on both sides:
 - Thick Paper 3, Thick Paper 4, Thin Paper, OHP (Transparency), Label Paper, CoatedPaper (Glossy:Thick), CoatedPaper(Matted:Thick), Waterproof Paper, Preprinted Paper, Envelope

Reference

- p.123 "Types of Paper and Other Media"

Loading Paper in Bypass Tray

This section explains how to load paper onto the bypass tray and change paper size.

Important

- Shuffle paper before loading the stack onto the tray, so multiple sheets are not fed in together.
- Set the size and direction of the loaded paper on the control panel or in the printer driver. Make sure the settings do not conflict. Otherwise, the paper may jam or the print quality may be affected.
- Load paper with the print side down and in the short-edge feed direction.

1. Press the mark in the centre of the bypass tray.

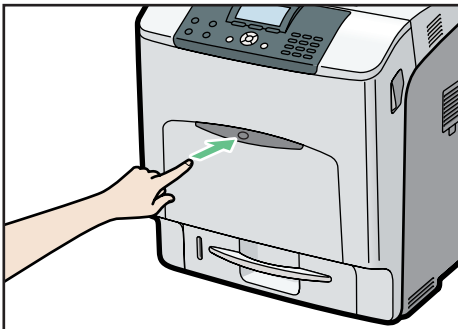

BYK090

Open the bypass tray.

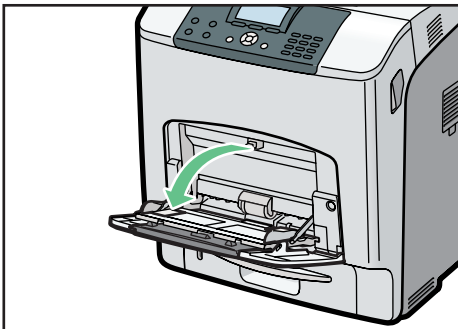

BYK091

2. If you load A5 or larger size paper, pull out the bypass tray extension, and then flip it open.

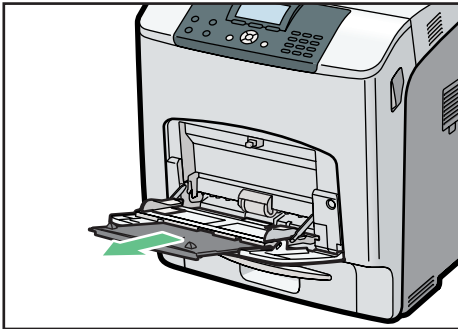

BYK092

3. Slide the side guides outward, and then load paper print side down, until it stops.

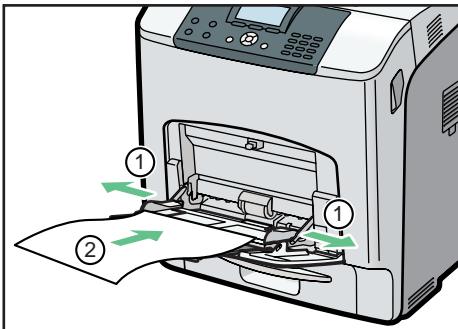

BYK093

4. Adjust the side guides to fit the paper width.



BYK094

Specifying standard size paper for the bypass tray

★ Important

- This describes how to load standard size paper onto the bypass tray.

1. Set the paper size using the control panel. Press the [Menu] key.

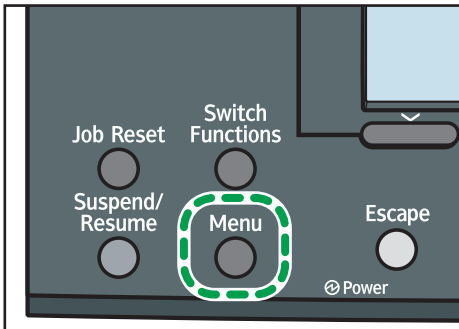

BYK087

2. Press the [▼] or [▲] key to select [Paper Input], and then press the [OK] key.

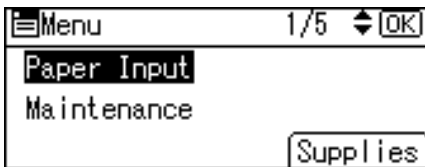

3. Press the [▼] or [▲] key to select [Paper Size:Bypass Tray], and then press the [OK] key.

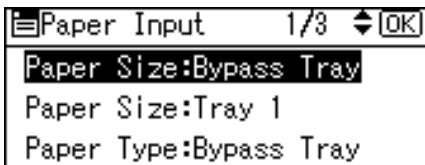

4. Press the [▼] or [▲] key to select the paper size you want to use, and then press the [OK] key.

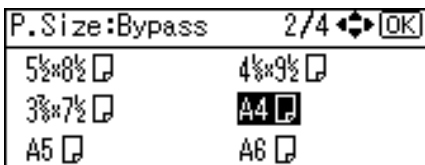

5. Press the [Menu] key to return to the initial screen.

Note

- After loading paper on the tray, specify the paper type using the control panel and printer driver.
- The number of pages that can be loaded on the bypass tray differs depending on paper type. Make sure paper is not stacked above the paper guides inside the bypass tray.

Specifying custom size paper for the bypass tray

★ Important

- When loading custom size or special paper, specify the paper size using the control panel and printer driver.
- Paper sizes between 70 - 216 mm (2.76 - 8.5 inches) in width and 127 - 1260 mm (5 - 49.6 inches) in length can be loaded in the bypass tray. However, the size range varies depending on a type of printer drivers. For details, see the printer driver Help.
- The custom size paper selected using the printer driver overrides that selected using the control panel.
- Do not make settings using the control panel if you have already made settings using the printer driver.
- You cannot print on custom size paper with an application that does not support the custom size setting.

1. Press the [Menu] key.

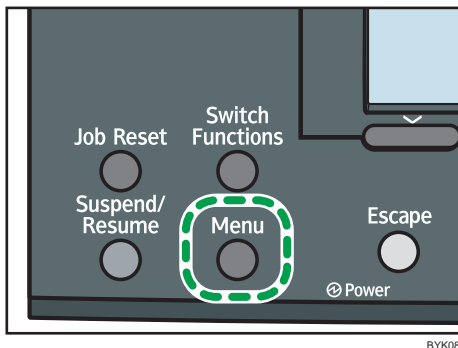

BYK087

2. Press the [▼] or [▲] key to select [Paper Input], and then press the [OK] key.

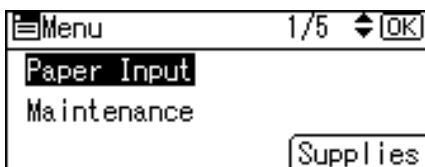

3. Press the [▼] or [▲] key to select [Paper Size:Bypass Tray], and then press the [OK] key.



4. Press the [▼] or [▲] key to select [Custom Size], and then press the [OK] key.

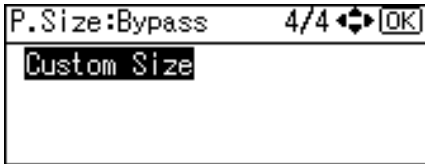

5. Press the number keys to enter the horizontal value, and then press the [OK] key.

Region A (mainly Europe and Asia)

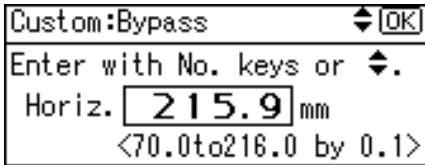

Region B (mainly North America)

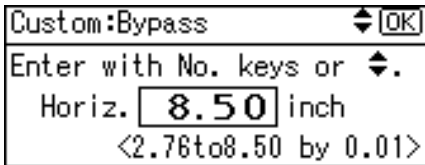

6. Press the number keys to enter the vertical value, and then press the [OK] key.

Region A (mainly Europe and Asia)

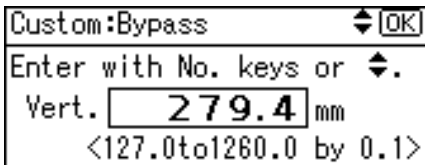

Region B (mainly North America)

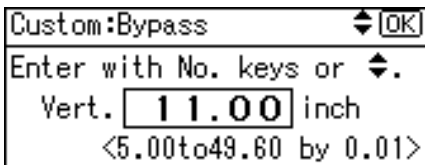

7. Press the [Menu] key to return to the initial screen.

Note

- For details about the printer driver, see the printer driver Help.

Specifying a paper type for the bypass tray

This section describes how to specify a paper type. You can improve printer performance by selecting the optimum paper type for the tray. You can select from the following paper types:

- No Display (Plain Paper), Middle Thick, Thick Paper 1, Thick Paper 2, Thick Paper 3, Thick Paper 4, Thin Paper, OHP (Transparency), Letterhead, Label Paper, Coated Paper (Glossy), CoatedPaper (Glossy:Thick), Coated Paper (Matted), CoatedPaper(Matted:Thick), Waterproof Paper, Special Paper 1, Special Paper 2, Special Paper 3, Preprinted Paper, Recycled Paper, Envelope

★ Important

- After loading paper on the tray, specify the paper type using the control panel and printer driver.
- The paper type selected using the printer driver overrides that selected using the control panel.

1. Press the [Menu] key.

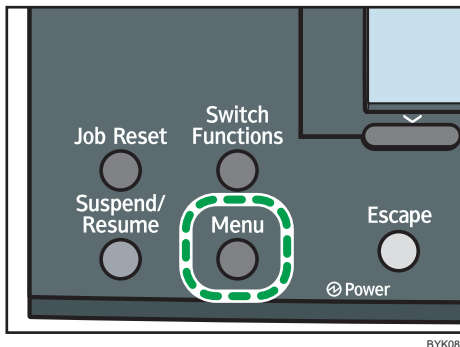

2. Press the [▼] or [▲] key to select [Paper Input], and then press the [OK] key.

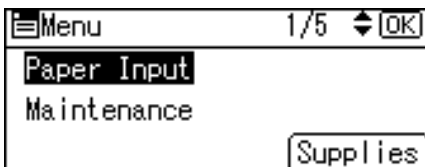

3. Press the [▼] or [▲] key to select [Paper Type:Bypass Tray] and then press the [OK] key.



4. Press the [▼] or [▲] key to select the paper type you want to use, and then press the [OK] key.

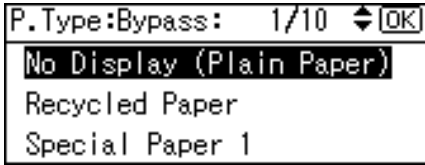

5. Press the [Menu] key to return to the initial screen.

Note

- If the printing result is badly smudged, change the setting on the printer's control panel. For details, see "Types of Paper and Other Media".
- The following paper types cannot be printed on both sides:
 - Thick Paper 3, Thick Paper 4, Thin Paper, OHP (Transparency), Label Paper, CoatedPaper (Glossy:Thick), CoatedPaper(Matted:Thick), Waterproof Paper, Preprinted Paper, Envelope

Reference

- p.123 "Types of Paper and Other Media"

Loading Envelopes

As there are many kinds of envelopes, be sure to check if those to be used are supported by this printer.

Reference

- p.123 "Types of Paper and Other Media"

Loading envelopes onto the bypass tray

Important

- Confirm that the envelope flaps are securely folded down, and that there is no air inside the envelopes.

1. Load envelopes until they stop, with the print side down and the sides of the flaps on the left as shown below.

Slide the side guides against the edge of the envelope stack.

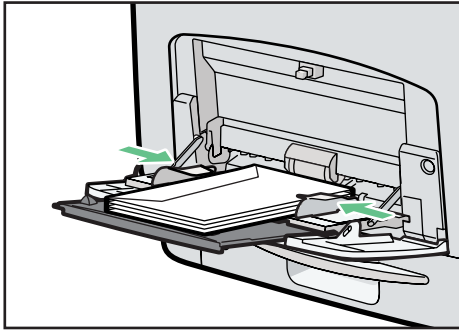

BYK095

- Set the envelope size and feed direction. Press the [Menu] key.

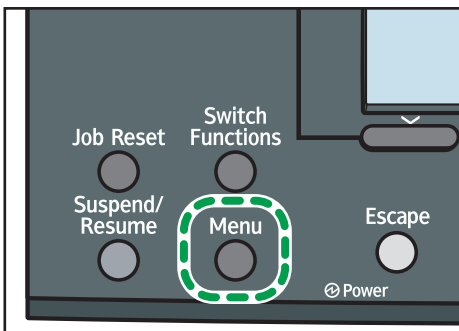

BYK087

- Press the [▼] or [▲] key to select [Paper Input], and then press the [OK] key.

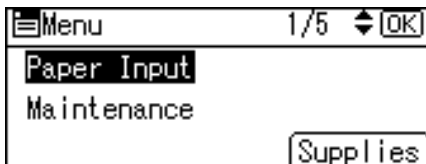

- Press the [▼] or [▲] key to select [Paper Size:Bypass Tray], and then press the [OK] key.

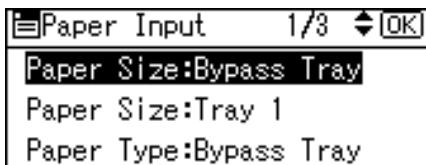

- Select the envelope type using the scroll keys, and then press the [OK] key.

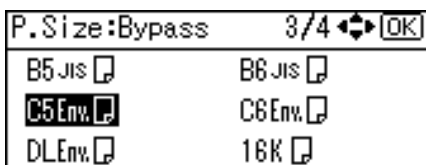

6. Press the [Menu] key.

The display returns to the initial screen.

Note

- Confirm that the top of the stack is not higher than the limit mark on the side guides.
- Do not push the stack of envelopes with too much force.
- Confirm that the edges of envelopes fit under the side guides.

Reference

- p.123 "Types of Paper and Other Media"

Loading envelopes into the standard paper feed tray

The following explanation uses the example of Loading envelopes into the standard paper feed tray (Tray 1).

1. Slowly slide out the paper tray (Tray 1), until it stops. Then, lift the front of the tray slightly, and then pull the tray completely out.

6

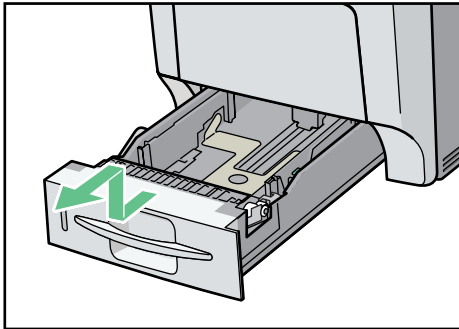

BYK078

Place the tray on a flat surface.

2. Pinch the green clips on the side guide and the end guide, and then adjust the guides to the envelope size being loaded.

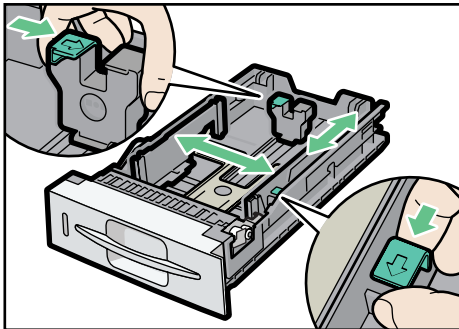

BYK079

3. Load envelopes into the paper tray, with the print side up and the flap on the left as shown in the illustration.

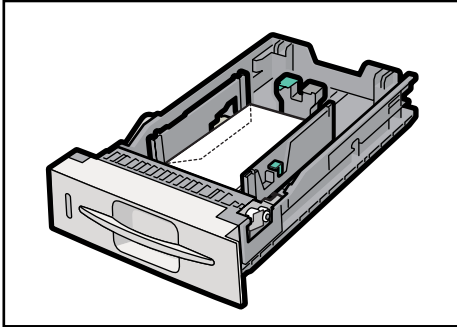

BYK096

4. Adjust the paper guides to close any gaps.

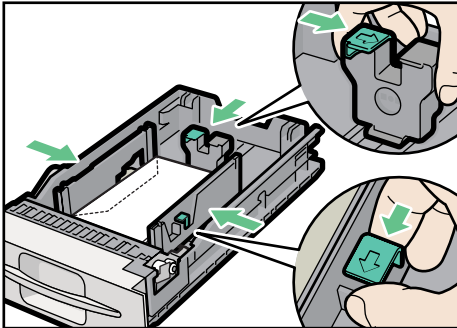

BYK125

5. Lift the front of the paper tray (Tray 1), and slowly slide the paper tray back in, until it stops. Make sure the tray is fully inserted to prevent a paper misfeed.

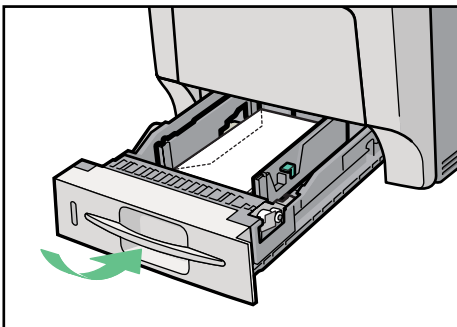

BYK082

6. Press the [Menu] key.

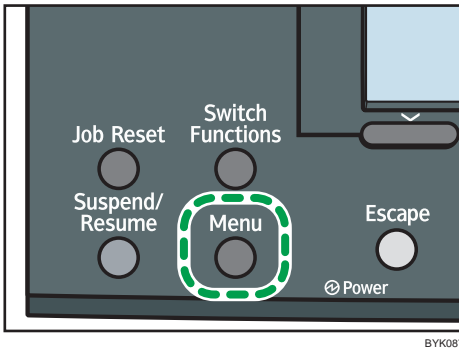

7. Press the [▼] or [▲] key to select [Paper Input], and then press the [OK] key.

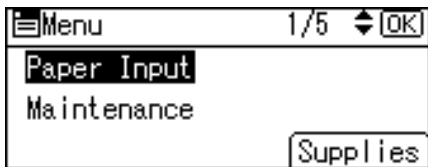

8. Press the [▼] or [▲] key to select [Paper Size:Tray 1], and then press the [OK] key.



9. Select the envelope type using the scroll keys, and then press the [OK] key.

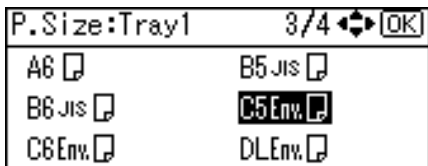

10. Press the [Menu] key.

The display returns to the initial screen.

Note

- Confirm that the top of the stack is not higher than the limit mark on the side guides.
- Confirm that the envelopes fit under the side guides.
- Do not push the stack of envelopes with too much force.
- Keep the removed paper tray with paper in a cool and dry place.

Reference

- p.123 "Types of Paper and Other Media"

Switching between Paper Trays

When paper of the same size is loaded in both the standard paper feed tray and optional paper feed tray, and when [Auto Tray Select] is set with the printer driver, paper will be fed from the standard paper feed tray when you start printing. To print on paper loaded in the optional paper feed tray, switch the tray to be used to the optional paper feed tray using [Tray Priority] in the [Paper Input] Menu.

1. Press the [Menu] key.

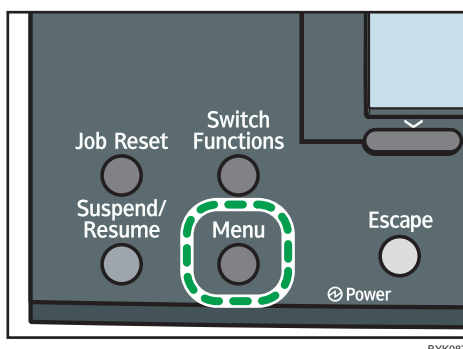

2. Press the [▼] or [▲] key to select [Paper Input], and then press the [OK] key.

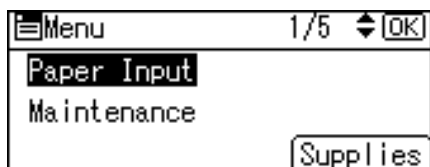

3. Press the [▼] or [▲] key to select [Tray Priority], and then press the [OK] key.

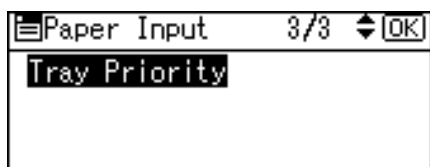

4. Press the [▼] or [▲] key to select the tray type you want to use, and then press the [OK] key.

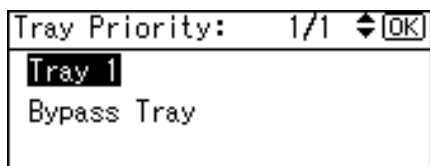

5. Press the [Menu] key to return to the initial screen.

The display returns to the initial screen.









Printing on Orientation-Fixed or Two-Sided Paper

This section explains how to print on paper whose orientation and printing side are unchangeable (letterhead paper, for example).

When loading paper with a fixed orientation, such as letterhead or letter paper, misprints may occur.

To make sure documents are printed correctly, press the [Menu] key using control panel, and in the [Print Settings] menu, select [Machine Modes], [Letterhead Setting] and [On (Always)] . Select [Letterhead] as the paper type in the printer driver's settings when you have selected [Auto Detect] or [Off] in the [Print Settings] menu.

For the letterhead print settings, see "Types of Paper and Other Media".

Paper Orientation	Paper trays 1 - 4		Bypass Tray	
	Letterhead Setting [On]	Letterhead Setting [Off]	Letterhead Setting [On]	Letterhead Setting [Off]
1-sided print ☞				
2-sided print ☞				

Note

- If you perform collated printing from a tray that is set for 2-sided printing, all printed after the first print will be output face-up instead of face-down, or vice versa. To ensure all paper is output facing the same direction, print from a tray that is not available for 2-sided printing.

Using Paper Types that Have Unique Names

From Registration of User Paper Types to Use

This section explains the procedures for selecting the paper type according to usage, registering the paper type under a unique name, and printing a file using the registered paper type.

★ Important

- This function can be used
 - when the printer is operating in a network,
 - in conjunction with the printer driver, and
- This function cannot be used
 - with the printer driver's [Manage Preset List...] function (registered paper types appear as [Plain] in the printer driver) and
 - if the printer and computer are not using bi-directional communication.
- Also, be aware that
 - the printer driver might not display the paper type name correctly if it is registered using an unsupported language,
 - the control panel might not display the paper type name correctly if it is registered using non-alphanumeric characters (i.e., other than a-z, A-Z, or 0-9), and
 - the printer's logs do not record names of user paper types.

The example below explains setting a custom type paper under the name "Invoice A" and feeding it from the bypass tray.

1. Using Web Image Monitor, register the name under [User Paper Type].
 - Enter "Invoice A" for [Paper Name] and select [Plain Paper (61 to 90g/m²)] for [Paper Type].
 - When printing a file, the paper type is automatically set by selecting [User Paper Types] on the printer driver setting screen.
 - For details about this procedure, see "Registering Names to Paper Types".
2. In Web Image Monitor, set [User Paper Type] for the bypass tray.
 - Set [Paper Type] for the tray to "Invoice A".
 - For details about this procedure, see "Setting User Paper Types to Trays".
3. Load the paper you want to use on the bypass tray.
 - Set an unprinted paper on the bypass tray.
 - For details about this procedure, see "Loading Paper".
4. Using the printer driver, print a document on the registered custom type paper.

- Select [Invoice A] for [Paper Type:], then proceed with the printing. When [Paper Type:] is set to [Invoice A], Plain paper that is suitable for "Invoice A" is selected automatically. Registering a descriptive name makes selecting a paper type from the [Paper Type:] list easier.
- For details about this procedure, see "Printing Using Registered Paper Types".

Note

- You can register up to eight user paper types.

Reference

- p.138 "Loading Paper"
- p.160 "Registering Names to Paper Types"
- p.161 "Setting User Paper Types to Trays"
- p.161 "Printing Using Registered Paper Types"

Registering Names to Paper Types

6

Important

- The control panel might not display the paper type name correctly if it is registered using non-alphanumeric characters (i.e., other than a-z, A-Z, or 0-9).

1. Log in to Web Image Monitor as an administrator.

For details about the login name and password, consult your network administrator.

2. In the menu area, click [Configuration].

3. In the [Device Settings] area, click [User Paper Type], and then change the settings as necessary.

The screen for selecting [User Paper Type] appears.

4. Make changes to the following settings:

Paper Name: Enter a descriptive name for easier recognition.

Paper Type: Select a suitable paper type from the list.

The example below is for printing invoices.

- Enter "Invoice A" for [Paper Name].
- Select [Plain Paper (61 to 90g/m²)] for [Paper Type]. If the setting is incorrect, the paper might become jammed or print quality could be affected.
- For details about combinations of paper sizes and types, see "Types of Paper and Other Media".

5. Click [OK].

Note

- You can register up to eight user paper types.

Setting User Paper Types to Trays

Before printing, set the paper registered on the user paper type to the paper tray, and then set the paper type already registered. Paper types can be set either from Web Image Monitor or from the printer's control panel.

- 1. Log in to Web Image Monitor as an administrator.**

For details about the login name and password, consult your network administrator.

- 2. In the menu area, click [Configuration].**

- 3. In the [Device Settings] area, click [Paper].**

- 4. Set the paper tray you want to use as a user paper type, and then select the registered paper type.**

The example below is for printing invoices.

The registered paper type "Invoice A" is displayed as [+ Invoice A (Custom x)] on this screen. Select [+ Invoice A (Custom x)] for [User Paper Type]. Make the appropriate changes to other settings as required.

- 5. Click [OK].**

- 6. Click [Logout].**

- 7. Quit Web Image Monitor.**

Note

- For details about loading paper, see "Loading Paper".
- For details about setting the paper type from the control panel, see "Specifying a paper type for standard paper feed tray and optional paper feed tray" and "Specifying a paper type for the bypass tray".

Reference

- p.138 "Loading Paper"
- p.144 "Specifying a paper type for standard paper feed tray and optional paper feed tray"
- p.151 "Specifying a paper type for the bypass tray"

Printing Using Registered Paper Types

Select a registered paper type to print onto.

- 1. Select your application's print command.**

- 2. On the tab in the properties dialog box that appears, select a registered paper type under [Paper Type:].**

If you select Custom Setting, click the [One Click Presets] tab.

3. Execute the print command.

The preregistered settings are applied and print is performed.

Note

- For details about printer driver settings, see the printer driver Help.

7. Maintaining the Printer

This chapter explains how to replace consumables, and clean the printer.

Adding Toner (Print Cartridge)

WARNING

- Do not incinerate toner (new or used) or toner containers. Doing so risks burns. Toner will ignite on contact with naked flame.

WARNING

- Do not store toner (new or used) or toner containers anywhere near naked flames. Doing so risks fire and burns. Toner will ignite on contact with naked flame.

WARNING

- Keep the polythene materials (bags, gloves, etc.) supplied with this machine away from babies and small children at all times. Suffocation can result if polythene materials are brought into contact with the mouth or nose.

CAUTION

- Do not crush or squeeze toner containers. Doing so can cause toner spillage, possibly resulting in dirtying of skin, clothing, and floor, and accidental ingestion.

CAUTION

- Keep toner (used or unused) and toner containers out of reach of children.

CAUTION

- If toner or used toner is inhaled, gargle with plenty of water and move into a fresh air environment. Consult a doctor if necessary.

CAUTION

- If toner or used toner gets into your eyes, flush immediately with large amounts of water. Consult a doctor if necessary.

CAUTION

- If toner or used toner is swallowed, dilute by drinking a large amount of water. Consult a doctor if necessary.

CAUTION

- When removing jammed paper or replacing toner, avoid getting toner (new or used) on your clothing. If toner comes into contact with your clothing, wash the stained area with cold water. Hot water will set the toner into the fabric and make removing the stain impossible.

CAUTION

- When removing jammed paper or replacing toner, avoid getting toner (new or used) on your skin. If toner comes into contact with your skin, wash the affected area thoroughly with soap and water.

Important

- When removing toner, be careful not to drop it.
- Do not forcefully push toner in.
- When handling toner, never stand them up on either end or position them upside down.
- Store toner in a cool dark place.

Note

- If toner are not changed when necessary, printing will become impossible. We recommend keeping a stock of containers.
- Toner (consumables) are not covered by warranty. However, if there is problem, contact the store where they were purchased.

Replace the toner cartridge if the following message appears on the display:

 Add Toner: (color)"

 Add toner <K,C,M,Y>
See instructions in Upper
Cover. Press the Menu key
to check Supplies.

- A combination of one to four colors, yellow, magenta, cyan, black, appears in "(color)".
- If cyan, magenta, or yellow toner runs out, you can print in black and white using black toner. Change the color mode setting to Black and White using the printer driver.
- If black toner runs out, you cannot print in black and white or color until the black toner cartridge is replaced.

When the following message appears on the display, the toner should be replaced soon. Prepare a new toner.

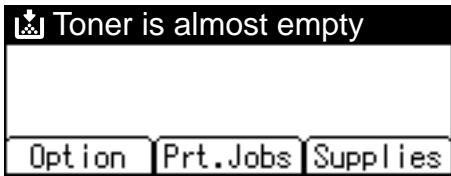

1. Open the top cover by pulling the handles on the left side.

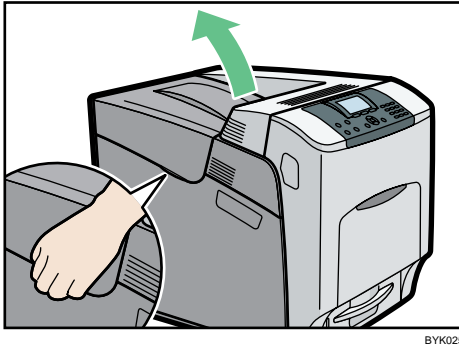

BYK025

From the back, the toner bottle is installed in the order of yellow (Y), magenta (M), cyan (C), and black (K).

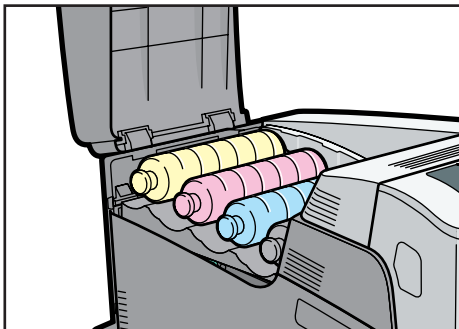

BYK127

2. Remove the toner bottle you want to replace.

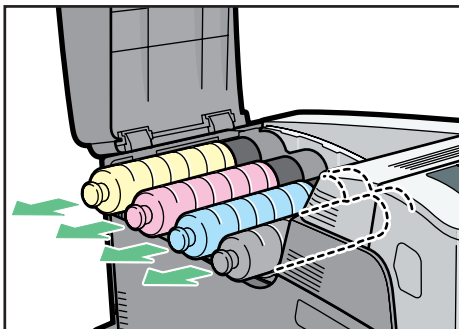

BYK114

- Do not shake the removed toner bottle. Any remaining toner may leak.

- Pull the toner bottle out slowly and carefully to prevent leakage.
- Place the old toner bottle on paper or some other material to avoid dirtying your workspace.

3. Take the new toner bottle out of its box, and then shake the toner bottle up and down seven or eight times. When holding or shaking the toner bottle, take care to hold the actual bottle, not the bottle's cover.

Even distribution of toner within the bottle improves print quality.

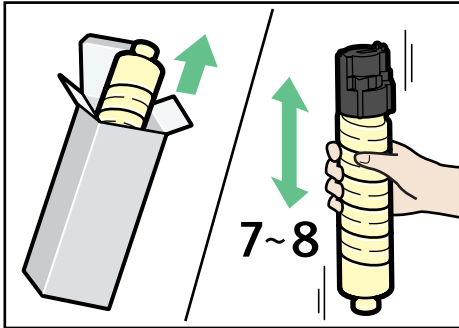

BYK111

4. Install the yellow toner bottle first. Holding the toner bottle horizontally with the label facing up, align the label with the position of the triangular mark.

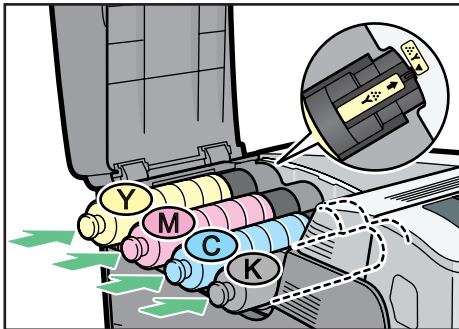

BYK113

Be sure to set the toner bottles so that they are straight and flat.

Carefully align the label on each toner bottle with the triangular mark on the receiving side.

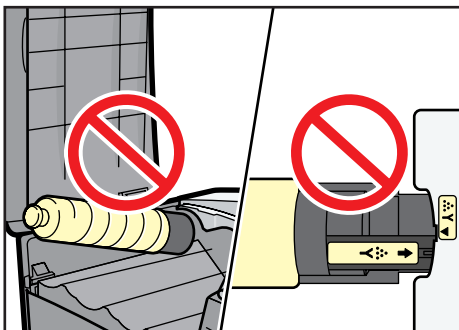

BYK121

5. Push in the toner bottle until you hear a clicking sound.

Do not repeatedly install and remove toner bottle. Doing so results in toner leak.

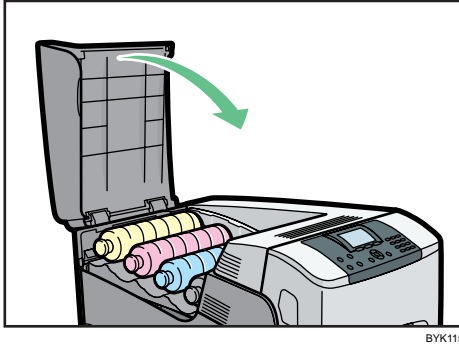
6. Close the top cover.

Wait while the toner loads.

To avoid malfunction, do not turn off the power while "Loading Toner" appears on the display.

Note

- Cooperate with the Toner Recycling Program, whereby are collected used toner. For details, consult with the dealer where you purchased the printer, or with a sales or service representative.

Replacing the Drum Unit

Refer to the maintenance guide provided with the new items for the replacement procedure of the drum unit.

★ Important

- Exposure to light reduces drum unit performance. Replace the unit as quickly as possible.
- Do not pull out the drum unit quickly or with force as it may fall.
- Take care that nothing comes into contact with the top surface of the drum unit.
- When holding the drum unit, grab the green grip on the left and the handle on the front together. Do not move the drum unit by only grabbing the grip. Doing so may damage the grip.
- The color drum units (yellow, magenta, and cyan) are supplied as a single item.

Black Drum Unit

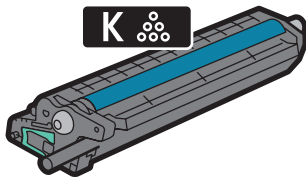

BYK100

Color Drum Units

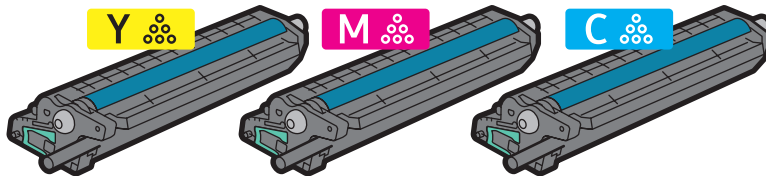

BYK101

Replace the black drum unit/color drum units if any of the following messages appear on the display:

"Rplcmnt Requird:PCU:Black"



"Rplcmnt Requird:PCU:Color"

Rplcmnt Requir:PCU:Color		
Option	Prt.Jobs	Supplies

When the following messages appear on the display, the black drum unit/color drum units should be replaced soon. Prepare a new Black Drum Unit/Color Drum Unit.

"Repl Rqrd Soon:PCU:Black"

Repl Rqrd Soon:PCU:Black		
Option	Prt.Jobs	Supplies

"Repl Rqrd Soon:PCU:Color"

Repl Rqrd Soon:PCU:Color		
Option	Prt.Jobs	Supplies

Replacing the Transfer Unit and Transfer Roller

Refer to the maintenance guide provided with the new items for the replacement transfer unit and transfer roller.

⚠ CAUTION

- The inside of the machine could be very hot. Do not touch the parts with a label indicating the "hot surface". Otherwise, an injury might occur.

★ Important

- Replace the transfer unit and transfer roller together.

Transfer Unit

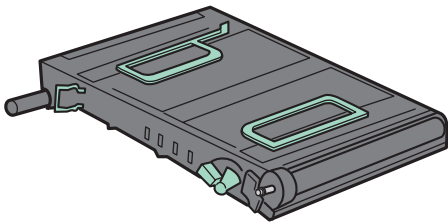

BYK130

Transfer Roller

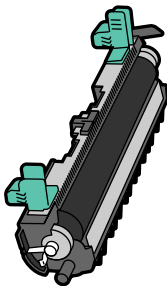

BYK131

Replace the transfer unit and transfer roller if the following message appears on the display:

"Replacmnt Requird:IntTrans"



When the following message appears on the display, the transfer unit and transfer roller should be replaced soon. Prepare a new Transfer Unit and Transfer Roller.

"Repl Rqrd Soon:IniTrans"



Replacing the Waste Toner Bottle

Refer to the maintenance guide provided with the new items for the replacement procedure of the waste toner bottle.

⚠ WARNING

- Do not incinerate toner (new or used) or toner containers. Doing so risks burns. Toner will ignite on contact with naked flame.

⚠ WARNING

- Do not store toner (new or used) or toner containers anywhere near naked flames. Doing so risks fire and burns. Toner will ignite on contact with naked flame.

⚠ WARNING

- Keep the polythene materials (bags, gloves, etc.) supplied with this machine away from babies and small children at all times. Suffocation can result if polythene materials are brought into contact with the mouth or nose.

⚠ CAUTION

- Keep toner (used or unused) and toner containers out of reach of children.

★ Important

- Waste toner bottles cannot be reused.
- Purchasing and storing extra waste toner bottles is recommended.
- Before removing the waste toner bottle from the printer, spread paper or some other material around the area to keep toner from dirtying your workspace.

Waste Toner Bottle

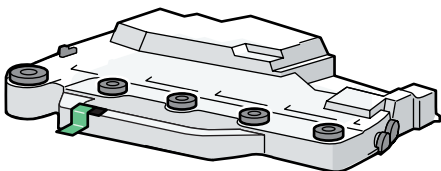

BYK106

Replace the waste toner bottle if the following message appears on the display:

" Waste Toner Bottle full"



When the following message appears on the display, the waste toner bottle should be replaced soon. Prepare a new Waste Toner Bottle.

"Waste Toner almost full"



Replacing the Fusing Unit and Dustproof Filters

Refer to the maintenance guide provided with the new items for the replacement procedure of the fusing unit and dustproof filters.

⚠ CAUTION

- The inside of the machine could be very hot. Do not touch the parts with a label indicating the "hot surface". Otherwise, an injury might occur.
- Wait at least one hour after power off before replacing parts. Not allowing the printer to cool may result in burns.

★ Important

- Replace the fusing unit and dustproof filters together.

Fusing Unit

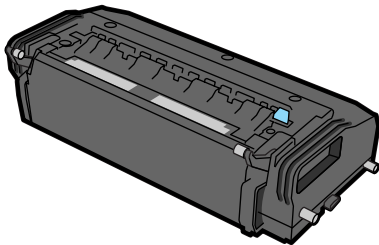

BYK133

Dustproof Filters

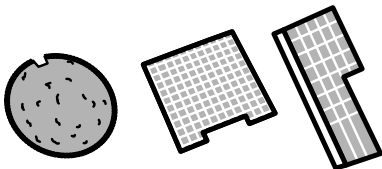

BYK134

Replace the fusing unit and dustproof filters if the following message appears on the display:

"Replcmnt Rqrd:Fusing Unit"



When the following message appears on the display, the fusing unit and dustproof filters should be replaced soon. Prepare a new Fusing Unit and Dustproof Filters.

"Repl Rqrd Soon:FusingUnit"



Cautions When Cleaning

WARNING

- Do not remove any covers or screws other than those explicitly mentioned in this manual. Inside this machine are high voltage components that are an electric shock hazard and laser components that could cause blindness. Contact your sales or service representative if any of the machine's internal components require maintenance, adjustment, or repair.
- Do not attempt to disassemble or modify this machine. Doing so risks burns and electric shock. Note again that exposure to the laser components inside this machine risks blindness.

CAUTION

- The inside of the machine could be very hot. Do not touch the parts with a label indicating the "hot surface". Otherwise, an injury might occur.

CAUTION

- Be sure to disconnect the plug from the wall outlet and clean the prongs and the area around the prongs at least once a year. Allowing dust to build up on the plug constitutes a fire hazard.

7

CAUTION

- If the machine's interior is not cleaned regularly, dust will accumulate. Fire and breakdown can result from heavy accumulation of dust inside this machine. Contact your sales or service representative for details about and charges for cleaning the machine's interior.

Clean the printer periodically to maintain fine printing.

Dry wipe the exterior with a soft cloth. If dry wiping is not enough, wipe with a soft, wet cloth that is wrung out well. If you still cannot remove the stain or dirt, apply a neutral detergent, and then wipe over with a well-wrung wet cloth, dry wipe, and then let it dry.

Important

- To avoid deformation, discoloration, or cracking, do not use volatile chemicals, such as benzine and thinner, or spray insecticide on the printer.
- If there is dust or grime inside the printer, wipe with a clean, dry cloth.
- You must disconnect the plug from the wall outlet at least once a year. Clean away any dust and grime from the plug and outlet before reconnecting. Accumulated dust and grime pose a fire hazard.

Cleaning the Paper Feed Roller

If the paper feed roller is dirty, multi-feeds or misfeeds might occur. In this case, clean the roller as shown below.

⚠ CAUTION

- When moving the machine, hold the inset grips at both sides, and then lift the printer slowly. Lifting it carelessly or dropping it may cause an injury.

⚠ CAUTION

- When performing maintenance on the machine, always disconnect the power cord from the wall outlet.

⚠ CAUTION

- When disconnecting the power cord from the wall outlet, always pull the plug, not the cord. Pulling the cord can damage the power cord. Use of damaged power cords could result in fire or electric shock.

★ Important

- Do not use chemical cleaner or organic solvent such as thinner or benzine.
1. Slowly slide the paper tray (Tray 1) out, until it stops. After that, lift the front of the tray slightly, and then pull the tray completely out.

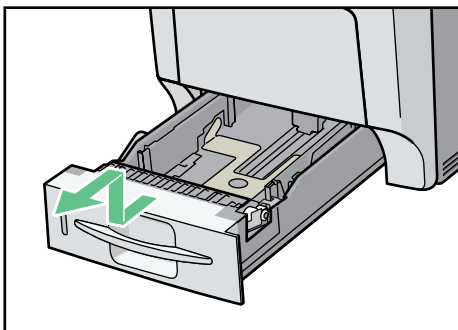

BYK078

2. Place the tray on a flat surface. When there is paper in the tray, remove paper.

3. Wipe the rubber part of the roller with a soft damp cloth. After that, wipe it with a dry cloth to remove the moisture.

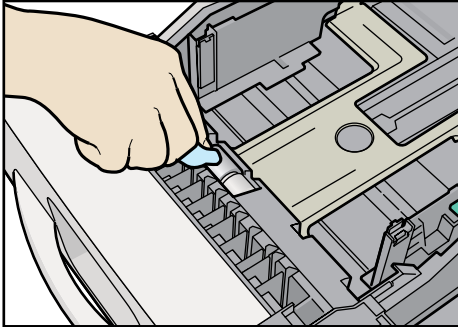

BYK083

4. Turn off the power switch.
5. Pull out the plug from the socket. Remove all the cables from the printer.
6. Move the printer to the edge of a stable table or desk.

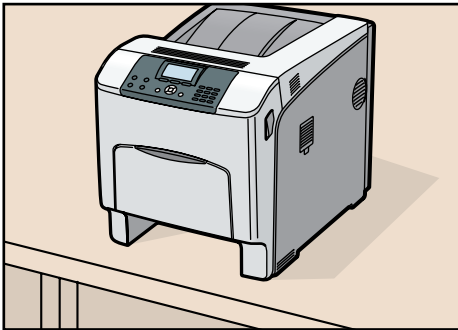

BYK107

Do not put the printer on an unstable or tilted surface.

If the printer is equipped with the optional paper feed unit, do not move the printer and unit together as they are not securely attached.

When lifting the printer, confirm that the optional paper feed unit is not attached to the printer.

7. Wipe the rubber part of the roller with a soft damp cloth. After that, wipe it with a dry cloth to remove the moisture.

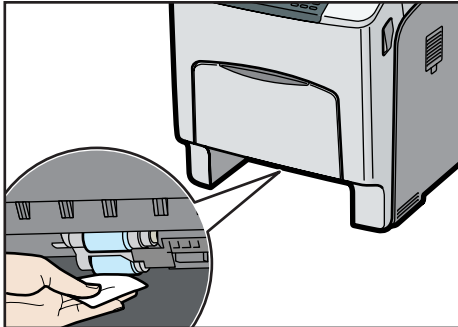

BYK084

Do not use chemical cleaner or organic solvent such as thinner or benzene.

8. Move the printer back to its original position. Lift the front of the tray, and slide it carefully into the printer until it stops.

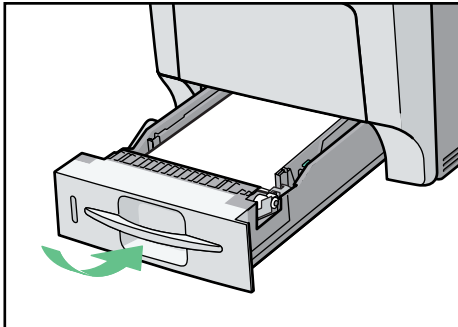

BYK082

Do not slide the paper tray in with force. If you do, the front and side guides might move.

9. Insert the plug of the power cord into the wall socket securely. Connect all the interface cables that were removed.
10. Turn on the power switch.

Note

- Follow the same procedure to clean the paper feed roller of the optional paper feed unit.

Cleaning the Registration Roller

⚠ CAUTION

- The inside of the machine could be very hot. Do not touch the parts with a label indicating the "hot surface". Otherwise, an injury might occur.

★ Important

- Do not use chemical cleaners or organic solvents such as thinners or benzine.
- Do not touch the belt of the roller when cleaning.
- Clean the registration roller if dots (caused by specks of paper stuck to the roller) appear on printed OHP transparencies.

1. Turn off the power, and then unplug the power cord.
2. Carefully open the printer's front cover by pulling the left and right side levers.

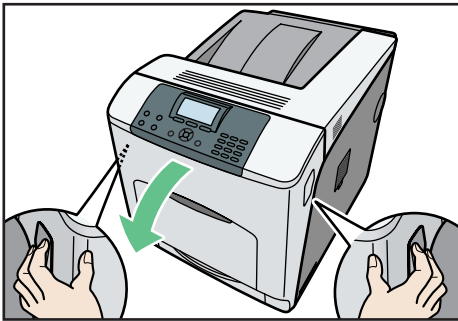

BYK135

3. Set the registration roller as shown.

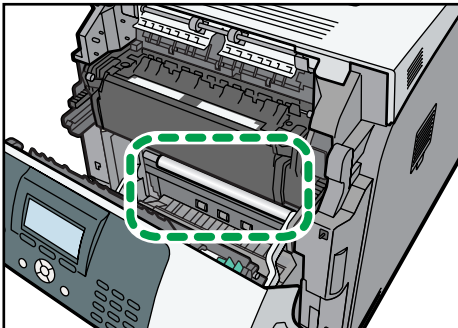

BYK085

4. Clean the registration roller by applying a soft damp cloth while turning it.

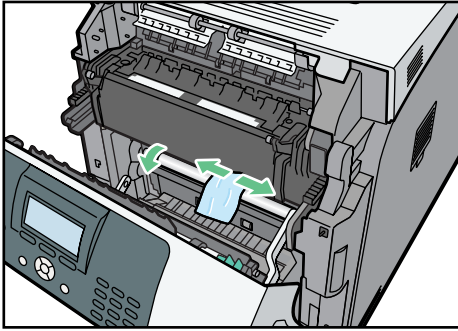

BYK086

5. Carefully close the front cover.
6. Plug in the power cord, and then turn on the power.

8. Adjusting the Printer

This chapter explains how to adjust the color gradations, color alignment, and print position.

Adjusting the Color Registration

This section describes automatic color adjustment.

After moving the printer, printing on thick paper, or printing repeatedly for some time, color degradation may occur. By performing automatic color adjustment, you can restore optimum print quality.

1. Press the [Menu] key.

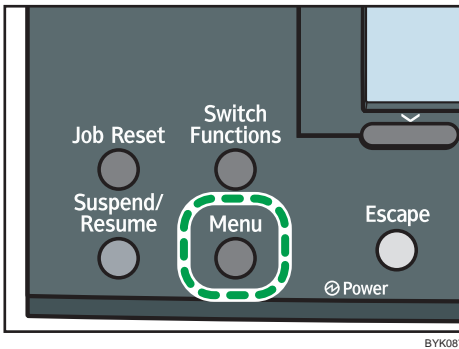

2. Press the [▼] or [▲] key to select [Maintenance], and then press the [OK] key.

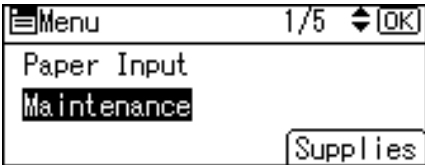

3. Press the [▼] or [▲] key to select [Quality Maintenance], and then press the [OK] key.

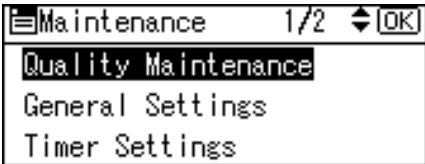

4. Press the [▼] or [▲] key to select [Color Registration], and then press the [OK] key.

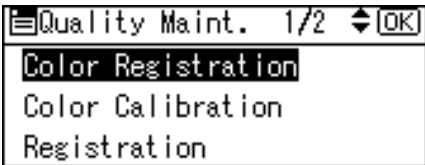

5. Select [Auto Adjust], and then Press the [OK] key.

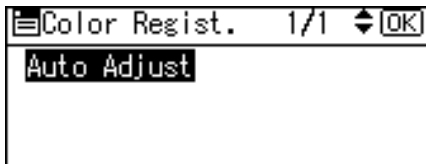

6. Press [OK].

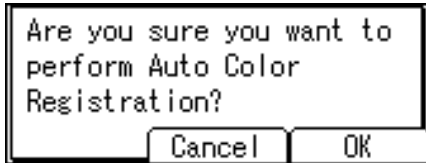

Automatic color adjustment begins.

Automatic color adjustment takes about 50 seconds.

A confirmation message appears when the adjustment is complete. Press [Exit].

7. Press the [Menu] key to return to the initial screen.

Correcting the Color Gradation

This section describes correcting the color gradation.

Color gradation during color printing can change slightly, depending on a number of factors. If you print the same file repeatedly or toner was recently replaced, changes may occur in color tones. In such cases, you can obtain optimal print results by correcting the color gradation.

Corrections to color gradation are performed in the following order:

1. Print gradation correction sheet 1.
2. Adjust the parts of highlight colors.

Set the correction value.

Print the gradation correction sheet, and then check the result of the correction.

3. Print gradation correction sheet 2.
4. Adjust the parts of middle colors.

Set the correction value.

Print the gradation correction sheet, and then check the result of the correction.

5. Save the correction value.

↓ Note

- If suitable results cannot be obtained after a single operation, repeat the correction several times, as needed.
- Corrections to color gradation will be applied to all user jobs.
- Use the same type of paper when printing a run of gradation corrections. If a different type of paper is used, corrections may not be apparent.
- This requires the use of the supplied Color Calibration Sample Sheet.

Setting the Gradation Correction Value

The following procedure describes adjusting the gradation correction value.

During printing, you can correct the gradation in two areas: bright part (highlight) and the medium (middle). The correction values for the highlight and the medium parts are set using [Print Test Pattern 1] and [Print Test Pattern 2] respectively.

1. Press the [Menu] key.

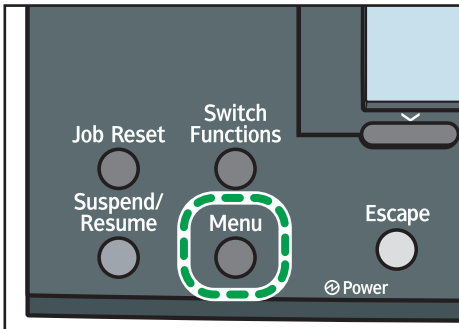

BYK087

2. Press the [▼] or [▲] key to select [Maintenance], and then press the [OK] key.

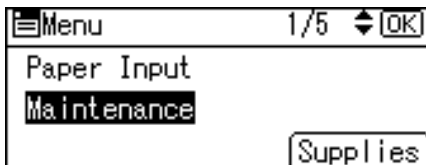

3. Press the [▼] or [▲] key to select [Quality Maintenance], and then press the [OK] key.

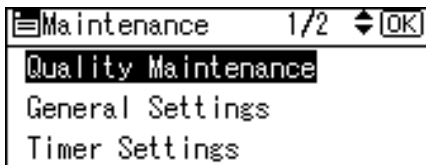

4. Press the [▼] or [▲] key to select [Color Calibration], and then press the [OK] key.

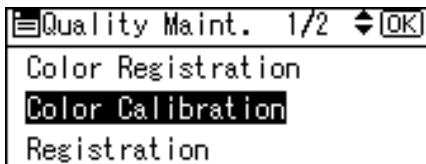

5. If you want to perform only auto color adjusting, press the [▼] or [▲] key select [Adjust Auto Density], and then press the [OK] key.

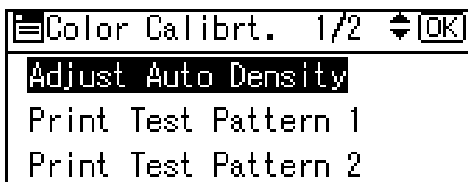

The confirmation message appears. Press [OK] to adjust Auto Density.

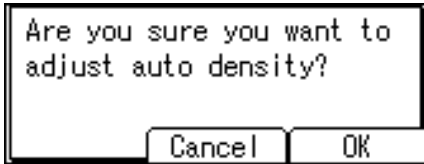

The confirmation message appears when complete. Press [Exit].

The display returns to the Color Calibration screen.

6. In the Color Calibration menu, press the [▼] or [▲] key to select [Print Test Pattern 1] or [Print Test Pattern 2], and then press the [OK] key.

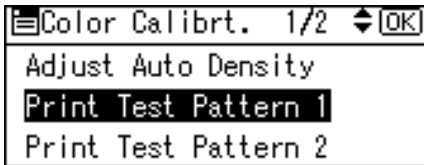

A confirmation message appears. Press [Print].

To cancel printing, press [Cancel].



7. When the selected sheet is printed, a confirmation message will appear. Press [Continue].

If you want to exit from this menu, press [Exit].

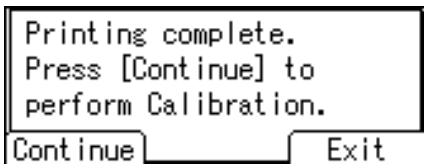

8. Press the [▼] or [▲] key to select the color you want to adjust, and then press the [OK] key.

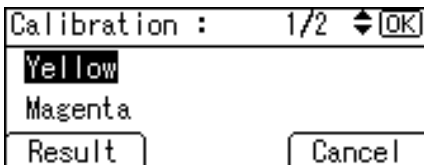

- 9. Press the number key (0-6) to adjust the correction value for the selected color, and then press the [OK] key.

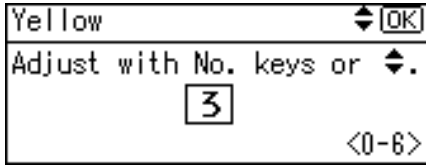

- 10. Press [Result].

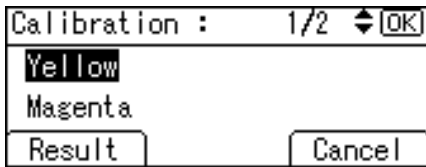

- 11. Press [Print] to check the result by printing the calibration sheet.

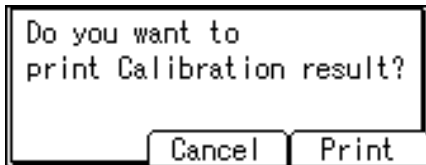

To cancel printing, press [Cancel].

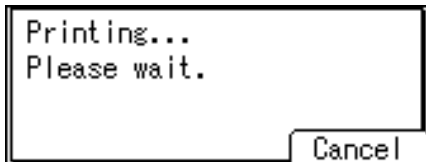

- 12. After printing, press [Yes] to save the settings.

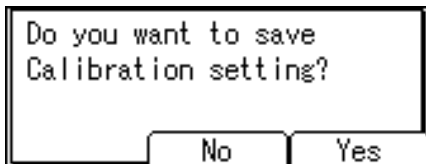

- 13. After completing all settings, press the [Menu] key to return to the initial screen.

Viewing the Color Calibration Sample Sheet and Gradation Correction Sheet

The Color Calibration Sample Sheet contains two color sample columns: "sample 1" column for adjusting highlights and "sample 2" column for adjusting midtones.

The gradation correction sheet contains "gradation correction sheet 1" for adjusting highlights and "gradation correction sheet 2" for adjusting midtones. Gradation correction sheet 1 is used for correction 1, while gradation correction sheet 2 is used for correction 2.

Color sample and correction values

The following explains how to view the color sample of the Color Calibration Sample Sheet and the correction values of the gradation correction sheet.

This explanation uses setting K (black) as an example. The setting method for M (magenta) is similar. For C/Y (cyan/yellow), the correction value is determined based on combinations of these two colors, although panel settings are configured for each color separately.

Note

- Hold the correction value (0 to 6) for "K" of the correction value setting sheet over the color sample of gradation correction 1 of the Color Calibration Sample Sheet and find the corrected color closest to that of the color sample. Then, enter the corresponding number using the operation panel. The currently set correction value is printed in red.

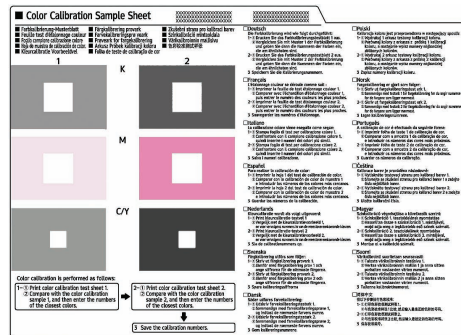
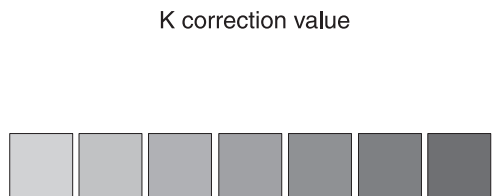

BFL360S

Reading the gradation correction sheet

The printed gradation correction sheet is read as shown below.

Comparing the gradation correction sheet and correction value of each color, K (black), M (magenta), and C (cyan)/Y (yellow) determine the required gradation correction and configure settings using the control panel.

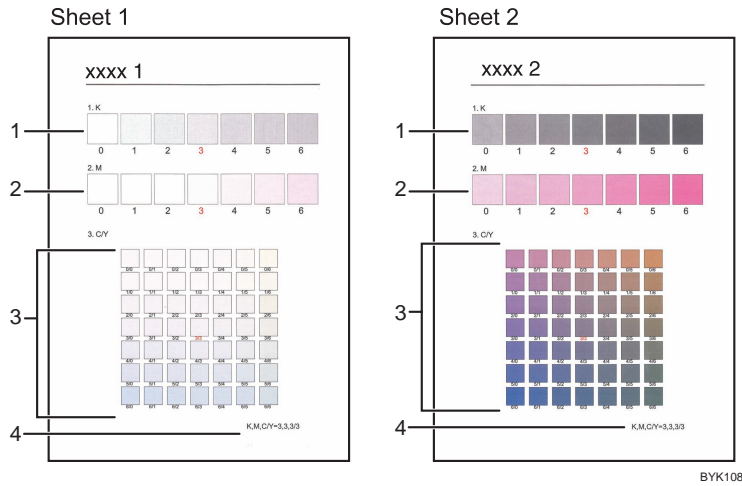

1. K (black) correction values

Used to adjust the color printed when only black toner is used. The currently set correction value is printed in red.

2. M (magenta) correction values

Used to adjust the color printed when only magenta toner is used. The currently set correction value is printed in red.

3. C (cyan)/Y (yellow) correction values

Used to correct the colors printed when cyan and yellow are used. For C/Y (cyan/yellow), the correction value is determined based on combinations of these two colors, although panel settings are configured for each color.

4. Setting value

The value displayed is the one currently set when the gradation correction sheet is printed. This value corresponds to the value set on the control panel.

Resetting the Gradation Correction Value to the Initial Value

Reset the correction value default.

1. Press the [Menu] key.

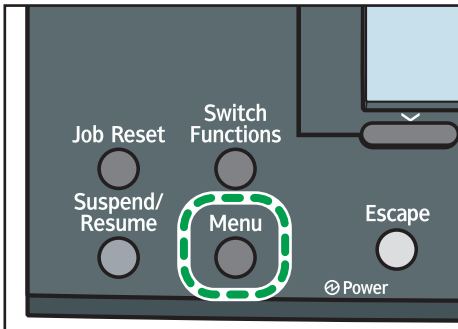

BYK087

2. Press the [▼] or [▲] key to select [Maintenance], and then press the [OK] key.

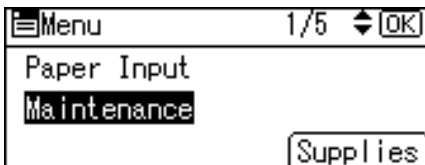

3. Press the [▼] or [▲] key to select [Quality Maintenance], and then press the [OK] key.

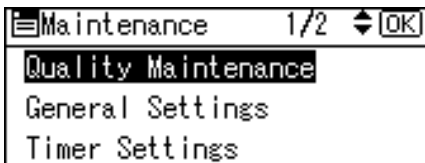

4. Press the [▼] or [▲] key to select [Color Calibration], and then press the [OK] key.

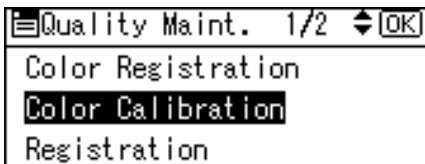

5. Press the [▼] or [▲] key to select [Reset Setting], and then press the [OK] key.

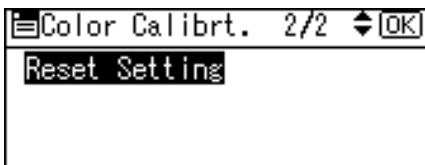

A confirmation message appears.

6. Press [Yes].

When resetting is completed, press [Exit].

7. Press [Menu] key to return to the initial screen.

Adjusting Printing Position

You can adjust the printing position for each tray. Only the horizontal printing position can be adjusted. "Horizontal" means perpendicular to the feed direction. Normally you do not need to update the printing position. However, updating is useful in some cases when the optional paper feed unit is installed.

1. Press the [Menu] key.

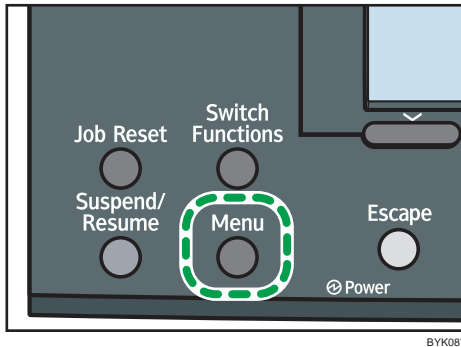

BYK087

2. Press the [▼] or [▲] key to select [Maintenance], and then press the [OK] key.

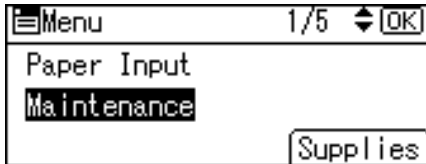

3. Press the [▼] or [▲] key to select [Quality Maintenance], and then press the [OK] key.

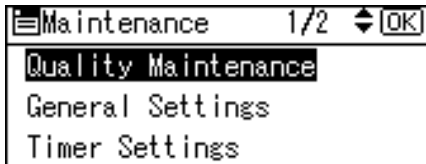

4. Press the [▼] or [▲] key to select [Registration], and then press the [OK] key.

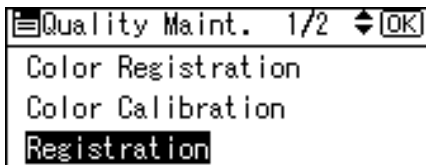

5. Press the [▼] or [▲] key to select [Print Test Sheet], and then press the [OK] key.

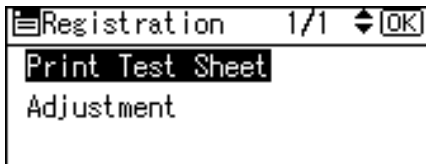

6. Press the [▼] or [▲] key to select the tray you want to adjust, and then press the [OK] key.
 7. Confirm the position of the image on the test sheet, and then adjust the registration value.

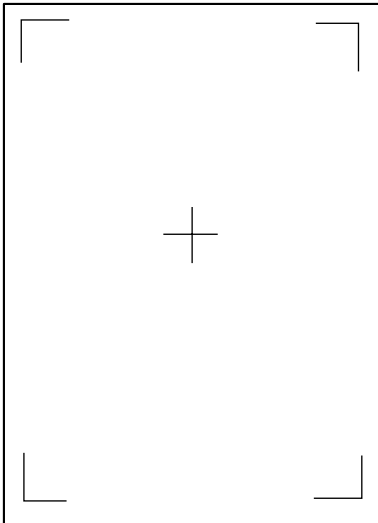

Use this sheet to confirm the current print position.

8. Press the [Escape] key until the screen returns to the [Registration] menu.
 9. Press the [▼] or [▲] key to select [Adjustment], and then press the [OK] key.

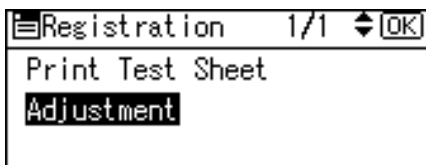

10. Press the [▼] or [▲] key to select the parameter you want to adjust, and then press the [OK] key.

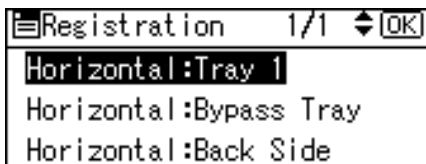

11. Press the [▼] or [▲] key to change the correction value (mm).

You can also use the number keys to change the value.

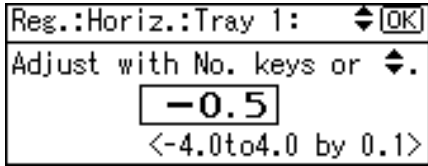

Increase the value to shift the print area in the direction indicated by the "+" symbol in the diagram below. Decrease the value to shift the print area in the direction indicated by the "-" symbol.

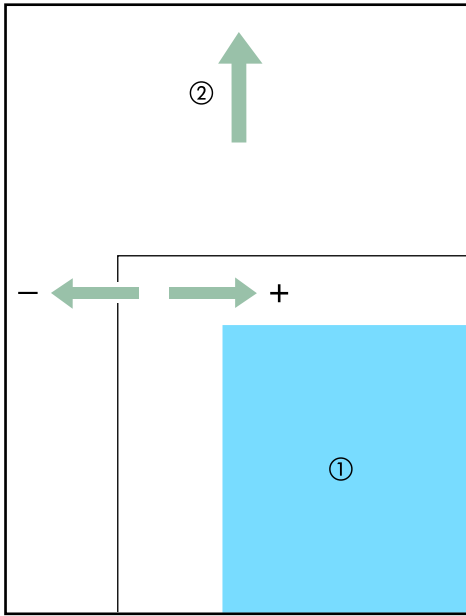

BFL383S

①: Print Area

②: Paper Feed Direction

Pressing the [▼] or [▲] key decreases or increases the value in steps of 1.0 mm.

12. Press the [OK] key to return to the [Registration] menu.

13. Print the test sheet to confirm the adjustment result.

14. Press the [Menu] key to return to the initial screen.

Adjusting the Paper Type

The following procedure explains how to change the paper thickness value.

1. Press the [Menu] key.

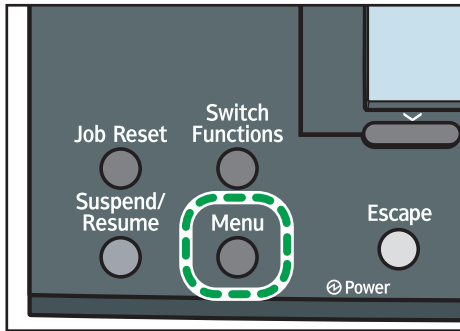

BYK087

2. Press the [▼] or [▲] key to select [Maintenance], and then press the [OK] key.

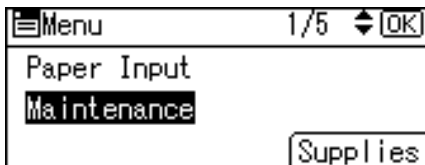

3. Press the [▼] or [▲] key to select [General Settings], and then press the [OK] key.

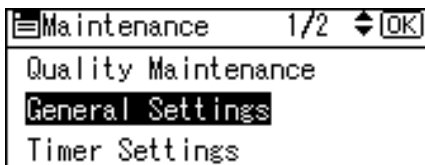

4. Press the [▼] or [▲] key to select the paper type you want to use, and then press the [OK] key.

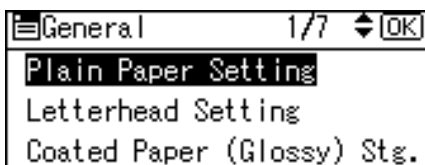

The following paper types are selectable:

Plain Paper, Letterhead, Coated Paper (Glossy), Coated Paper (Glossy:Thick), Coated Paper (Matted), Coated Paper (Matted:Thick), Waterproof Paper, Label Paper, Envelope.

5. If you have selected the [Plain Paper Setting], select the tray you want to set using the [▼] or [▲] key, and then press the [OK] key.

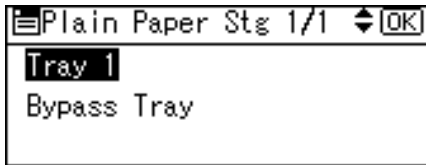

6. Press the [▼] or [▲] key to select the paper setting, and then press the [OK] key.

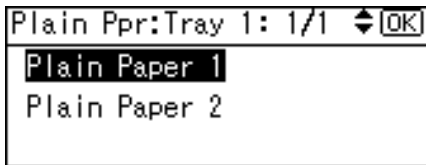

7. Press the [Menu] key to return to the initial screen.

9. Troubleshooting

This chapter provides solutions to common problems and it also explains how to correct unwanted print results.

Error and Status Messages Appear on the Control Panel

This section explains what the messages that appear on the control panel mean and what to do when a particular message appears.

Status Messages (in alphabetical order)

Calibrating...

The printer is calibrating the color. Wait a while.

Energy Saver

The printer is in Energy Saver mode. Press any key to recover to the normal mode.

Hex Dump Mode

In Hex Dump mode, the printer receives data in hexadecimal format. Turn off the printer after printing, and then turn back on.

Loading toner...

The printer is loading toner. Wait a while.

Please wait...

This message may appear for a few seconds. It means the printer is initializing, replenishing toner, or executing maintenance operations. Wait a while.

Printing...

The printer is printing. Wait a while.

Printing Suspended

Printing is suspended. To cancel the suspension, turn the printer off, wait a few moments, and then turn it back on.

Ready

This is the default ready message. The printer is ready for use. No action is required.

Resetting Job...

The printer is resetting the print job. Wait a while.

Setting change...

The printer is applying the changes made to its settings. Wait a while.

Waiting for print data...

The printer is waiting for the next data to print. Wait a while.

Alert Messages (in alphabetical order)**⚠(A) Remove misfeed in Trays. Opn & cls Frt Cov.**

Remove paper from the standard paper feed tray (Tray1) and then reload paper. Then open the front cover and then close it again, so the error message disappears.

For details, see p.218 "Paper Misfeed Message (A)".

⚠(B) (C) Open Front Cover and remove the paper.

Open the front cover and remove any jammed paper from the internal paper feed path.

For details, see p.219 "Paper Misfeed Message (B) (C)".

⚠(Y2) Remove misfeed in Tray 2. Opn & cls Frt. Cov.

Remove paper from the tray 2 and then reload paper. Then open the front cover and then close it again, so the error message disappears.

For details, see p.222 "Paper Misfeed Message (Y)".

⚠(Y3) Remove misfeed in Tray 3. Opn & cls Frt. Cov.

Remove paper from the tray 3 and then reload paper. Then open the front cover and then close it again, so the error message disappears.

For details, see p.222 "Paper Misfeed Message (Y)".

⚠(Y4) Remove misfeed in Tray 4. Opn & cls Frt. Cov.

Remove paper from the tray 4 and then reload paper. Then open the front cover and then close it again, so the error message disappears.

For details, see p.222 "Paper Misfeed Message (Y)".

⚠(Z) Open Frt. Cov and remove paper in Dup.Feed.

Open the front cover and remove any jammed paper from the duplex unit.

For details, see p.224 "Paper Misfeed Message (Z)".

🖨️ Add toner<K, C, M, Y>.

The printer has run out of the indicated toner. Replace the indicated toner cartridge.

For details, see p.163 "Adding Toner (Print Cartridge)".

📄 Toner is almost empty.

The printer is almost out of the toner indicated in the message. Contact your sales or service representative to obtain a new unit.

📄 Waste Toner almost full Contact your local vendor. Please call service.

The waste toner bottle is almost full. Contact your sales or service representative.

📄 Waste Toner Bottle full

Replace the waste toner bottle. For details, see p.172 "Replacing the Waste Toner Bottle".

Cannot connect with DHCP server.(101/201)

Cannot obtain IP address from DHCP server. Consult your network administrator.

Cannot connect with NetWare print server. (107/207)

Connection with NetWare print server is unavailable.

Cannot connect with NetWare server.(106/206)

Connection with NetWare server is unavailable. Consult your network administrator.

Cannot print.

Check the file you want to print is a supported file type. Check for misfeeds and ask your network administrator for help.

Check network settings.(103/203)

The IP address setting is incorrect. Check the IP address, subnet mask, and gateway address. For details, see p.93 "Ethernet Configuration".

Check the Left Cover is closed and the Waste Toner Bottle is set correctly.

Make sure the left cover is firmly closed. If the error message persists, remove the waste toner bottle and set it again.

Classification Code Error

A classification code is not specified for the print job. Enter a classification code using the printer properties and print the document again.

For details, see "Registering Classification Codes", Software Guide.

Connect failed:Wireless Card Turn power off, check card

Check there is a wireless LAN board installed.

Check that it is a supported board. If it is, check it is installed correctly.

Install the correct board properly.

For details, see p.75 "Installing the Interface Units".

Cover Open. Please close the indicated cover.

Close the cover indicated on the control panel.

Ethernet Board Error

An error on the Ethernet board is detected. Pull out and then re-install the controller board. If the problem persists, contact your sales or service representative.

IPv6 Address already exists Link-local Address(109/209)

The same IPv6 address already exists. Consult your network administrator.

IPv6 Address already exists Stateless Address(109/209)

The same IPv6 address already exists. Consult your network administrator.

IPv6 Address already exists Manual Config. Address (109/209)

The same IPv6 address already exists. Consult your network administrator.

Option RAM Error

The printer cannot detect an optional SDRAM module. It may be incorrectly installed.

Check if it is installed properly.

For details about installing the unit, see p.67 "Installing the Memory Expansion Units".

Parallel I/F Error

The printer's self diagnostic test failed due to a loopback error. Replace the IEEE 1284 board that caused the error.

For details, see p.75 "Installing the Interface Units".

Printer Font Error.

There are problems with the printer's font file.

Contact your sales or service representative.

Problem with Hard Disk Please call service.

The printer cannot detect a hard disk. It may be incorrectly installed.

Check if it is installed properly or contact your sales or service representative.

For details about installing the unit, see p.75 "Installing the Interface Units".

Problem:Wireless board Please call service.

The printer cannot detect a wireless LAN board failure. It may be incorrectly installed.

Check if it is installed properly or contact your sales or service representative.

For details about installing the unit, see p.75 "Installing the Interface Units".

Problem:Wireless card Please call service.

The printer cannot detect a wireless LAN board. It may be incorrectly installed.

Check if it is installed properly or contact your sales or service representative.

For details about installing the unit, see p.75 "Installing the Interface Units".

Repl Rqrd Soon:FusingUnit

You will need to replace the fusing unit soon. Contact your sales or service representative to obtain a new unit.

Repl Rqrd Soon:IntTrans

You will need to replace the transfer unit soon. Contact your sales or service representative to obtain a new unit.

Repl Rqrd Soon:PCU:Black

You will need to replace the black drum unit soon. Contact your sales or service representative to obtain a new unit.

Repl Rqrd Soon:PCU:Color

You will need to replace the color drum units soon. Contact your sales or service representative to obtain a new unit.

Replacmnt Requird:IntTrans

You need to replace the transfer unit. For details, see p.170 "Replacing the Transfer Unit and Transfer Roller".

Replcmnt Rqrd:Fusing Unit

You need to replace the fusing unit. For details, see p.174 "Replacing the Fusing Unit and Dustproof Filters".

Rplcmnt Requird:PCU:Black

You need to replace the black drum unit. For details, see p.168 "Replacing the Drum Unit".

Rplcmnt Requird:PCU:Color

You need to replace the color drum units. For details, see p.168 "Replacing the Drum Unit".

Set the Fusing Unit correctly.

The fusing unit may not be installed correctly. Turn the printer off and re-install the fusing unit.

If the message is still displayed after re-installation, contact your sales or service representative.

For details, see p.174 "Replacing the Fusing Unit and Dustproof Filters" for fusing unit installation.

Set the Intermediate Transfer Unit correctly.

The transfer unit may not be installed correctly. Turn the printer off and re-install the transfer unit.

If the message is still displayed after re-installation, contact your sales or service representative.

For details, see p.170 "Replacing the Transfer Unit and Transfer Roller" for transfer unit installation.

This NetBIOS name is already in use.(108/208)

The NetBIOS name specified for the machine is already in use by another device on the network. Consult your network administrator.

The same IPv4 Address already exists.(102/202)

The IPv4 address specified for the machine is already in use by another device on the network. Consult your network administrator.

The selected job has already been printed or deleted.

This message might appear if you print or delete a job from Web Image Monitor. Press Exit on the message screen.

Values set for IPv6/Gateway addresses are invalid.(110/210)

The IPv6 address or gateway address is invalid. Check the network settings.

WPA Auth. incomplete.(211)

WPA authentication could not complete. Consult your network administrator.

Note

- Confirm error details by printing the Error Log. For details, see "Test Printing".

Reference

- p.55 "Test Printing"

Panel Tones

The following table explains the meaning of the various tone patterns that the printer emits to alerts users about its condition.

Tone pattern	Meaning	Cause
Two long beeps.	Printer ready.	After cooling or being switched on, the printer has fully warmed up and is ready for use.
Single short beep.	Panel/screen input accepted.	A valid control panel or screen key was pressed. Single short beeps are produced only when valid keys are pressed.
Single long beep.	Job completed.	A Printer job has finished.
Four long beeps.	Printer initialized.	The screen is changing back to the initial screen after the printer came out of the energy-saving mode or was reset.
Five short beeps repeated five times.	Printer alert.	Printer requires user attention. Paper may have jammed or toner may need replenishing.

★ Important

- Users cannot mute the printer's tone alerts. When the printer beeps to alert users of a paper jam or toner request, if the printer's covers are opened and closed repeatedly within a short space of time, the tone alert might continue, even after normal status has resumed.

Printer Does Not Print

Is the power on?

Confirm that the cable is securely plugged into both the power outlet and the printer.
Turn on the power.

Does the Alert indicator stay red?

If so, check the error message on the display and take the required action.
For details, see p.197 "Error and Status Messages Appear on the Control Panel".

Is paper loaded?

Load paper into the paper tray or onto the bypass tray.
For details, see p.138 "Loading Paper".

Can you print a configuration page?

If you cannot print a configuration page, it probably indicates a printer malfunction. Contact your sales or service representative.
For details, see p.55 "Test Printing".

Is the interface cable connected securely to the printer and the computer?

Connect the interface cable securely. If it has a fastener, fasten it securely as well.

Are you using the correct interface cable?

The type of interface cable you should use depends on the computer you use. Be sure to use the correct one.

If the cable is damaged or worn, replace it with a new one.
For details, see p.232 "Specifications".

Is the Data In indicator blinking or lit after starting a print job?

If not blinking or lit, the data is not being sent to the printer.

If the printer is connected to the computer using the interface cable

Check the port connection setting is correct. For details about checking the port connection, see p.205 "Checking the Port Connection".

Network Connection

Consult your network administrator.

How is the signal strength when using the wireless LAN?

802.11 Ad hoc Mode

Either move to a location where the signal is good, or remove obstructions.

Infrastructure Mode

Check the signal status in the [Wireless LAN] menu on the control panel. If the signal is poor, either move to a location where it is good, or remove obstructions.

Checking the Port Connection

When the Data in indicator does not flash or light up, check the port connection as shown below to confirm the setting.

- For a parallel port connection, the port must be set to LPT 1 or LPT 2.
 - For a USB port connection, the port must be set to USB00(n)*.
- * (n) varies depending on the number of printers connected.

Windows 2000

1. Click the [Start] button, point to [Settings], and then click [Printers].
2. Click the icon of the printer. On the [File] menu, click [Properties].
3. Click the [Ports] tab.
4. In the [Print to the following port(s)] list, confirm the correct port is selected.

Windows XP Professional or Windows Server 2003/2003 R2

1. Click the [Start] button, and then click [Printers and Faxes].
2. Click the icon of the printer. On the [File] menu, click [Properties].
3. Click the [Ports] tab.
4. In the [Print to the following port(s)] list, confirm the correct port is selected.

Windows XP Home Edition

1. Click the [Start] button, and then click [Control Panel].
2. Click [Printers and Other Hardware].
3. Click [Printers and Faxes].
4. Click the icon of the printer. On the [File] menu, click [Properties].
5. Click the [Ports] tab.
6. In the [Print to the following port(s)] list, confirm the correct port is selected.

Windows Vista/ Windows Server 2008

1. Click the [Start] button, and then click [Control Panel].
2. Click [Printers].
3. Click the icon of the printer. On the [Organize] menu, click [Properties].

4. Click the [Ports] tab.
5. In the [Print to the following port(s)] list, confirm the correct port is selected.

Other Printing Problems

When You Cannot Print Properly

Toner smears appear on the print side of the page.

- The paper setting may not be correct. For example, you are using thick paper but the setting for thick paper might not be set.
- Check the paper settings.
- Check the printer driver's paper settings. See the printer driver Help.
- When the message "Rplcmnt Requird:PCU:Black" or "Rplcmnt Requird:PCU:Color" appears on the display, replace the drum unit. For details, see p.168 "Replacing the Drum Unit".
- Check that the paper is not curled or bent. Envelopes can easily become curled. For details, see p.123 "Paper Recommendations".

Photo images are coarse.

- Some applications lower the resolution for making prints.
Raise the resolution in the settings of the application.

Fine dot patterns do not print.

- Change the [Dithering:] setting in the printer driver's dialog box.
For details, see the printer driver Help.

Solid lines are printed as broken lines.

- Change the [Dithering:] setting in the printer driver's dialog box.
For details, see the printer driver Help.

The whole printout is blurred.

- The paper is damp, probably due to improper storage. Use dry paper that has been stored properly.
For details, see p.123 "Paper Recommendations".
- If you select [On] for [Economy Color:] on the [Print Quality] menu in the printer properties dialog box, print will be at lower density.
For details, see the printer driver Help.
- Toner is almost depleted. When the "Out of toner" / "(color)", or "Toner is almost empty" / "(color)" message appears on the display panel, or the toner indicator on the initial screen shows empty, replace the toner with new toner of the appropriate color.
For details, see p.163 "Adding Toner (Print Cartridge)".
- When the message "Rplcmnt Requird:PCU:Black" or "Rplcmnt Requird:PCU:Color" appears on the display, replace the drum unit.

For details, see p. 168 "Replacing the Drum Unit".

- Condensation may have collected. If rapid change in temperature or humidity occurs, use this printer only after it has acclimatized.

White streaks or color streaks appear.

- Toner is almost depleted. When the "Out of toner" / "(color)", or "Toner is almost empty" / "(color)" message appears on the display panel, or the toner indicator on the initial screen seems empty, replace the toner of the displayed color.

For details, see p. 163 "Adding Toner (Print Cartridge)".

- When the message "Rplcmnt Requird:PCU:Black" or "Rplcmnt Requird:PCU:Color" appears, replace the drum unit.

For details, see p. 168 "Replacing the Drum Unit".

- The paper is damp. Use paper that has been stored at a suitable temperature and humidity.

Specks of paper may be attached to the registration roller. Clean the registration roller.

For details, see p. 180 "Cleaning the Registration Roller".

Specks of paper may be attached to the registration roller. Clean the registration roller.

For details, see p. 180 "Cleaning the Registration Roller".

The backs of printed sheets are blemished.

- When removing a jammed sheet, the inside of the printer may have become dirtied. Print several sheets until they come out clean.
- If document size is larger than paper size, e.g. A4 document on B5 paper, the back of the next printed sheet may be dirtied.

9

If rubbed with your finger, it smears out.

- The setting of the paper may not be correct. For example, although thick paper is used, the setting for thick paper may not be set.

On the [Paper] tab of the printer driver, set [Paper Type:] to [Thick 1 (106 to 130 g/m²)] or [Thick 2 (131 to 163 g/m²)].

- Check the paper settings of this printer.

For details, see p. 123 "Types of Paper and Other Media".

- Check the paper settings of the printer driver.

For details, see the printer driver Help.

- The fusing unit is deteriorated or damaged. Replace the unit.

For details, see p. 174 "Replacing the Fusing Unit and Dustproof Filters".

When printing on OHP transparencies, a color is missing or black or white dots are obvious.

- The registration roller is dirty. Clean the registration roller.

For details, see p.180 "Cleaning the Registration Roller".

When printing on plain paper, white dots are obvious.

- The registration roller is dirty. Clean the registration roller.

For details, see p.180 "Cleaning the Registration Roller".

Paper Misfeeds Occur Frequently

Paper jams occur frequently.

- Number of paper set in the tray exceeds the limit. Confirm that the top of the stack is not higher than the limit mark inside the tray.

For details, see p.138 "Loading Paper".

- There may be a gap between the front guide and the paper, or between the side guides and the paper in the paper tray. Make sure there are no gaps.

For details, see p.138 "Loading Paper".

- Paper is either too thick or too thin.

For details, see p.123 "Types of Paper and Other Media".

- Paper is bent or wrinkled. Use paper that have no bents or wrinkles.

For details, see p.123 "Paper Recommendations".

- Paper has already been printed on.

For details, see p.123 "Types of Paper and Other Media".

- Paper is damp. Use paper that has been stored properly.

For details, see p.123 "Types of Paper and Other Media".

- When loading paper, separate paper from each other.

Multiple pages are fed at once.

- Paper is either too thick or too thin.

For details, see p.123 "Paper Recommendations".

- Paper has already been printed on.

For details, see p.123 "Paper Recommendations".

- Number of paper set in the tray exceeds the limit. Confirm that the top of the stack is not higher than the limit mark inside the tray.

For details, see p.138 "Loading Paper".

- Paper is static. Use paper that has been stored properly.

For details, see p.123 "Paper Recommendations".

- When loading paper, separate paper from each other.

Paper gets wrinkles.

- Paper is damp. Use paper that has been stored properly.
For details, see p.123 "Paper Recommendations".
- Paper is either too thick or too thin.
For details, see p.123 "Types of Paper and Other Media".
- There may be a gap between the front guide and the paper, or between the side guides and the paper in the paper tray. Make sure there are no gaps.
For details, see p.138 "Loading Paper".
- The fusing unit is deteriorated or damaged. Replace the unit.
For details, see p.174 "Replacing the Fusing Unit and Dustproof Filters".

The printed image is different from the image on the computer

A printed image is different from the image on the computer's display.

- When you use some functions, such as enlargement or reduction, the layout of the image might be different from that displayed on the computer display.

Images are printed at an angle

- Confirm that the side guides of the paper tray are locked.
If paper is not loaded correctly, it may be processed at an angle.

Images are cut off, or excess pages are printed.

- If you are using paper smaller than the paper size selected in the application, use the same size paper as that selected in the application. If you cannot load paper of the correct size, use the reduction function to reduce the image, and then print.
For details, see the printer driver Help.

PDF Direct Print is not executed (PDF file is not printed).

- You must install an optional hard disk drive or set the value of [RAM Disk] in the System Menu to 2 MB or higher.
For details about [RAM Disk], see "System Menu", Software Guide.
- After adding a memory unit and setting the value of [RAM Disk] in the System Menu to 16 MB, value of [RAM Disk] returns to 0 MB if the memory unit is removed. If this happens, reset the value of [RAM Disk] to 2MB or higher.
For details about [RAM Disk], see "System Menu", Software Guide.
- When printing a PDF with a password set, set the password of the PDF file using the [Change PDF Password] menu in [PDF Menu] or Web Image Monitor. For details about [Change PDF Password], see "PDF Menu", Software Guide.

For details about Web Image Monitor, see Web Image Monitor Help.

- PDF files not allowed to be printed by the PDF file security setting cannot be printed.
- Highly compressed PDFs cannot be printed using PDF Direct Print.

Open the relevant application and print the PDF file using the printer driver.

Set the file format to standard PDF.

As a result of printing using PDF Direct Printing, characters are missing or misshapen.

- Before printing, embed the font in the PDF file to be printed.

The paper size appears on the control panel and printing is not performed with PDF Direct Print.

- When using PDF Direct Print, printout requires paper set within the PDF file. When a message indicating a paper size appears, either place the indicated size in the paper tray, or perform Form Feed.

Also, if [Sub Paper Size] in the [System] Menu is set to [Auto], printing is performed assuming letter size and A4 size to be the same size. For example, When a PDF file set to A4 size paper is printed using PDF Direct Print and letter size paper is loaded in the paper tray, the file will be printed out. This applies similarly to the opposite case.

The color of the printout is different from the color on the computer's display.

- The colors made using color toner are different from colors displayed on the display in its production system.
- If you select [On] for [Economy Color:] on the [Print Quality] menu in the printer driver's dialog box, the color gradation may appear differently.

For details, see the printer driver Help.

Color changes extremely when adjusted with the printer driver.

- Do not make extreme settings for the color balance on the "Print Quality" tab in the printer driver's dialog box.

Note that the sample image displayed in the printer driver is used only to show what processing will be performed, so may not match the print results.

For details, see the printer driver Help.

Color documents are printed in black and white.

- The printer driver is not set up for color printing.

For details, see the printer driver Help.

- Some applications print color files in black and white.

Solid areas, lines or text are shiny or glossy when created as a mixture of cyan, magenta, yellow.

- Select [K (Black)] for [Gray reproduction (Text/Line Art):] in the printer driver's dialog box.

For details, see the printer driver Help.

Black gradation is not natural.

- Select [CMY + K] for [Gray reproduction (Text/Line Art):] in the printer driver's dialog box.

For details, see the printer driver Help.

A color is missing or partially blurred.

- Paper is damp. Use paper that has been stored properly.

For details, see p. 138 "Loading Paper".

- Toner is almost depleted. When the "Out of toner" / "(color)", "Toner is almost empty." / "(color)", or "Add Toner:" message appears on the display panel, or the toner indicator on the initial screen seems empty, replace the toner of the displayed color.

For details, see p. 163 "Adding Toner (Print Cartridge)".

- When "Rplcmnt Requird:PCU:Black" or "Rplcmnt Requird:PCU:Color" appears on the display, replace the drum unit.

For details, see p. 168 "Replacing the Drum Unit".

- Condensation may have collected. If rapid change in temperature or humidity occurs, use this printer only after it has acclimatized.

White or color rivers appear.

- When the message "Rplcmnt Requird:PCU:Black" or "Rplcmnt Requird:PCU:Color" appears, replace the drum unit.

For details, see p. 168 "Replacing the Drum Unit".

Printed pages are faint, or have white streaks.

- If  is flashing, toner is almost depleted. Add toner.

For details, see p. 163 "Adding Toner (Print Cartridge)".

When Printer is Not Functioning Properly

Paper is not fed from the selected tray.

- When you are using a Windows operating system, the printer driver settings override those set using the control panel. Set the desired input tray using the printer driver.

For details, see the printer driver Help.

It takes too much time to turn on the printer.

- If the printer is turned off while it is still accessing the hard disk (for example: during file deletion), the printer will require more time to power-up the next time it is turned on. To avoid this time delay, do not turn the power off while it is in operation.

It takes too much time to resume printing.

- The data is so large or complex that it takes time to process it. If the data in indicator is blinking, the data is being processed. Just wait until it resumes.
- If an OHP transparency or glossy paper is being used, printing takes more time to start.
- The printer was in the Energy Saver mode. To resume from the Energy Saver mode, the printer has to warm up, and this takes time until printing starts. To disable the Energy Saver mode, select [Off] for [Energy Saver On/Off] in the [System], [Energy Saver] menu.

It takes too much time to complete the print job.

- Photographs and other data intensive pages take a long time for the printer to process, so simply wait when printing such data.

Changing the settings with printer driver may help to speed up printing.

For details, see the printer driver Help.

- The data is so large or complex that it takes time to process it. If the data in indicator is blinking, the data is being processed. Just wait until it resumes.
- If "Waiting for print data..." appears on the display, the printer is now warming up. Wait for a while.

With Windows 2000/XP/Vista, Windows Server 2003/2003 R2/2008, attached options are not detected.

- The computer and printer are not in two-way communication. You must configure attached options in the printer properties.

For details, see the printer driver Help.

If the problem cannot be solved, contact your sales or service representative.

With Windows 2000/XP/Vista, Windows Server 2003/2003 R2/2008, when doing aggregate prints or bound prints.

- Check that the paper size and direction set in the [Menu] tab of the printer driver are the same as those set in the application.

If the settings are not the same, change the settings of the printer driver.

Some complex images do not print out on large custom size paper, such as paper with a length of 1260 mm (Type 1 model only).

- If the image prints out when a lower resolution is set, the printer does not have enough memory to process the image. To print the image at higher resolution, install the optional memory.

An empty tray is selected by Auto Tray Select, and the document does not print out due to out of paper error.

- If a paper tray is opened and closed while the printer is in Energy Saver mode, the printer will initialize the tray upon recovery, but the tray will not be selectable by Auto Tray Select.

To print from a paper tray that you have opened and closed while the printer was in Energy Saver mode, you must manually specify the tray as the source paper tray before printing. When the printer recovers from Energy Saver mode and completes initialization, it will then print the document from the tray you have specified.

Additional Troubleshooting

Strange noise is heard.

- If a supply was recently replaced or an option attached in the area the strange noise is coming from, check the supply or option is properly attached. If the strange noise persists, contact your sales or service representative.

No e-mail is received when an Alert occurs, and after resolving an Alert.

- Confirm [Auto E-mail Notify] is active in the [System] Menu on the Control Panel. See "System Menu", Software Guide.
- Access the printer through a Web browser, log in as an Administrator on Web Image Monitor, and then confirm the following settings in [Auto E-mail Notification]:
 - Device E-mail Address
 - Groups to Notify
 - Select Groups/Items to Notify

For details about the settings, see Web Image Monitor Help.

- Access the printer through the Web browser, log in as an Administrator on the Web Image Monitor, and then confirm the settings of the SMTP server in [E-mail]. For details about the settings, see Web Image Monitor Help.
- When the power is turned off before the e-mail is transmitted, the e-mail will not be received.
- Check the e-mail address set for the destination. Confirm the printer's operation history using Web Image Monitor's System Log menu in [Network]. If the e-mail was sent but not received, it is possible the destination was incorrect. Also check the information concerning error mail from the e-mail server.

The setting for [Auto E-mail Notify] on the System Menu was changed from [Off] to [On], but e-mail is not arriving.

- After changing the setting, turn the printer's power off and then back on again.

Error notification e-mail was received, but no error-solved e-mail is received.

- Check e-mail is set for sending using Web Image Monitor's [Auto E-mail Notification] at the time the error was fixed. You must click the [Edit] button of [Detailed Settings of Each Item] in [Auto E-mail Notification], and set [Notify when error:] to [Occurs & Fixed] on the displayed screen.

For details about the settings, see Web Image Monitor Help.

Alert Resolving is set for sending e-mail, but no Alert-resolved e-mail is sent.

- If the power of the printer is turned off after an alert occurs, and the alert is resolved during the time the power is off, no Alert-resolved e-mail is sent.

Alert Occurrence and Alert Resolving are set for sending e-mail, but while no Alert Occurrence mail is received, Alert-resolved e-mail is received.

- Alert-notification e-mail is not sent if the problem is resolved before sending. However, an Alert-resolved e-mail is sent.

Alert-notification level was changed, and e-mail stopped arriving.

- If an Alert-notification e-mail, set with the earlier notification level, arrives, later e-mail will not be sent, even if the notification level is changed after.

When no date information is included in sent e-mail, the mail server has a malfunction.

- Configure the setting for obtaining time information from the SNTP server. Refer to Web Image Monitor's Help to the settings.

There is toner remaining in the toner bottle.

- Depending on the environment in which the printer is located, there might be toner remaining in the toner bottle. If there is, remove the toner bottle and set it again. The printer will attempt to reload the toner automatically, and you might be able to continue operation if there is enough toner left in the bottle.

Note

- If the printer is still not operating satisfactorily, contact your sales or service representative. Consult with the store where the printer was purchased for information about the location of sales or service representatives.

10. Removing Misfed Paper

This chapter explains how to remove misfed paper.

Removing Misfed Paper

An error message appears if a paper misfeed occurs. The error message gives the location of the misfeed. Check the location and remove the paper.

CAUTION

- The inside of this printer becomes very hot. Do not touch parts labeled "△" (indicating a hot surface). Touching these parts will result in burns.

CAUTION

- Some of this machine's internal components get very hot. For this reason, take care when removing misfed paper. Not doing so could result in burns.

CAUTION

- When removing jammed paper or replacing toner, avoid getting toner (new or used) on your clothing. If toner comes into contact with your clothing, wash the stained area with cold water. Hot water will set the toner into the fabric and make removing the stain impossible.

CAUTION

- When removing jammed paper or replacing toner, avoid getting toner (new or used) on your skin. If toner comes into contact with your skin, wash the affected area thoroughly with soap and water.

Important

- Do not forcefully remove misfed paper, it may tear and torn pieces may remain inside the printer.
- When paper is misfed a number of times, the following are possible causes.
 - The control panel settings do not match the size or orientation of the loaded paper.
 - The paper feed roller is dirty.
- For details about cleaning the paper feed roller, see "Cleaning the Paper Feed Roller".
- Misfed paper may be covered with toner. Be careful not to get toner on your hands or clothes.
- If paper is still misfed after you have checked the above-mentioned causes, contact your sales or service representative.

Reference

- p.177 "Cleaning the Paper Feed Roller"

Paper Misfeed Message (A)

The "Error (A) Remove misfed in Trays. Opn & cls Frt Cov." error message appears when a paper misfeed occurs in the standard paper feed tray.

★ Important

- Forcefully removing misfed paper may cause paper to tear and leave scraps of paper in the printer. This might cause a misfeed and damage the printer.

1. Pull out the paper tray, and then carefully remove any misfed paper.

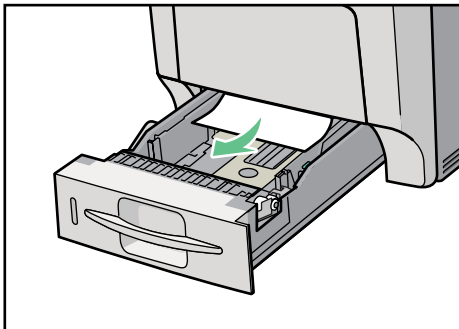

BYK136

2. Push in the paper tray. Make sure the tray is securely inserted to avoid paper jams.
3. Carefully open the printer's front cover by pulling the left and right side levers.

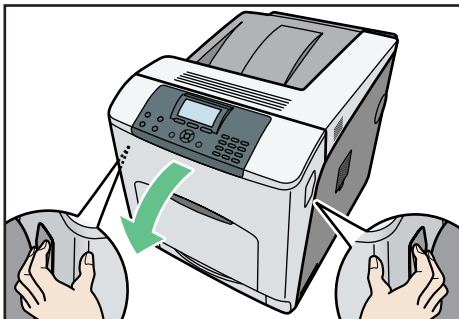

BYK135

4. Carefully close the front cover.

↓ Note

- When closing the front cover, push the upper side of the cover firmly. After closing the cover, check that the error has cleared.

Paper Misfeed Message (B) (C)

The "⚠(B)(C) Open Front Cover and remove the paper." error message appears when a paper misfeed occurs in the internal paper feed path.

⚠ CAUTION

- The inside of this printer becomes very hot. Do not touch parts labeled "⚠" (indicating a hot surface). Touching these parts will result in burns.

★ Important

- Forcefully removing misfed paper may cause paper to tear and leave scraps of paper in the printer.
- Remove the paper from the bypass tray before opening the front cover.
- If a misfeed occurs when using the bypass tray, open the front cover, and then remove the misfed paper.
- The inside of this printer becomes very hot. Before removing paper around the fusing unit, wait until the temperature of the covers inside the fusing unit and duplex unit cool down.

1. Carefully open the printer's front cover by pulling the left and right side levers.

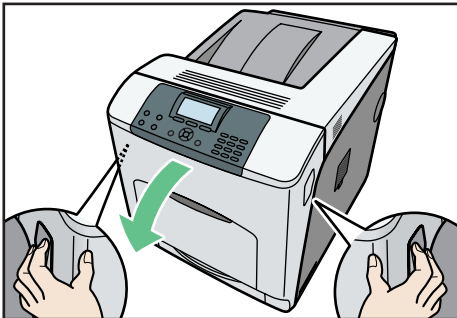

BYK135

2. Remove misfed paper slowly.

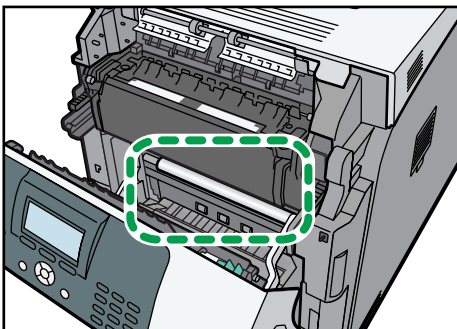

BYK085

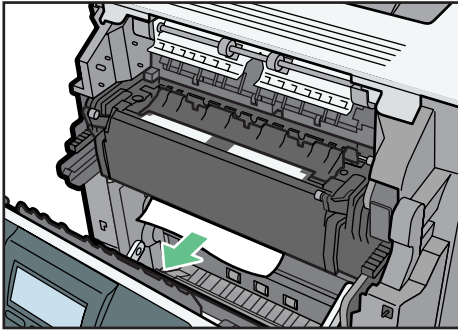

BYK137

If you cannot find the misfed paper, look inside the printer.

3. If a misfeed occurs in the output area of the fusing unit, open the output cover by pulling back the levers marked "C" (left and right on the fusing unit's upper side).

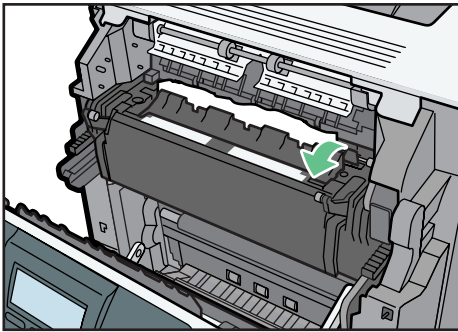

BYK116

4. Remove misfed paper slowly.

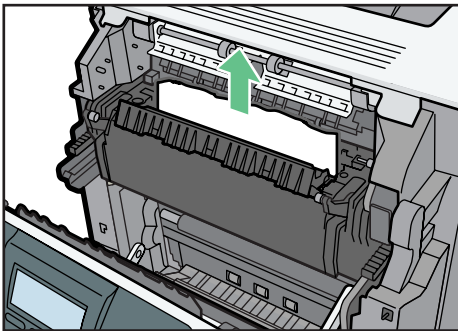

BYK117

5. Close the output cover of the fusing unit.

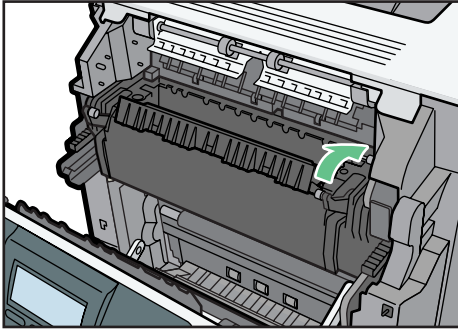

BYK118

6. Carefully close the front cover.

↓ Note

- When closing the front cover, push the upper side of the cover firmly. After closing the cover, check that the error has cleared.

Paper Misfeed Message (Y)

The "Ⓜr(Y2) Remove misfeed in Tray 2. Opn & cls Frt. Cov.", "Ⓜr(Y3) Remove misfeed in Tray 3. Opn & cls Frt. Cov." or "Ⓜr(Y4) Remove misfeed in Tray 4. Opn & cls Frt. Cov." error message appears when a paper misfeed occurs in the paper feed section.

★ Important

- Forcefully removing misfed paper may cause paper to tear and leave scraps of paper in the printer. This might cause a misfeed and damage the printer.

1. Pull out the optional paper tray until it stops, and then remove the jammed paper.

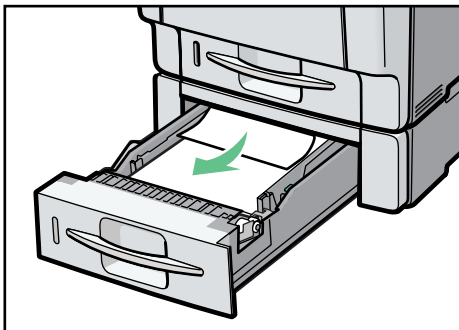

BYK138

2. Carefully slide the tray back into the optional paper feed until it stops.

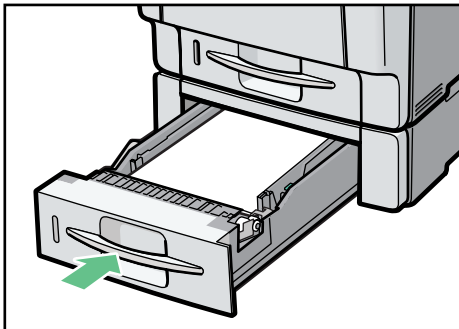

BYK139

3. Carefully open the printer's front cover by pulling the left and right side levers.

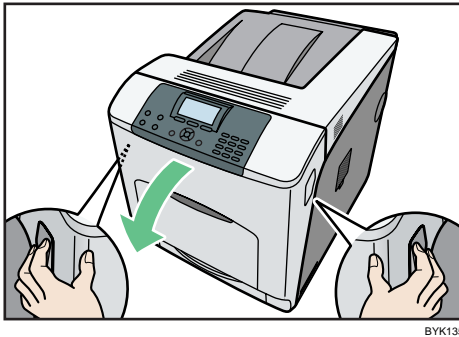

4. Carefully close the front cover.

↓ **Note**

- If a paper jam occurs in one of the optional paper feed trays, pull out all the paper trays above the tray in which the jam occurred, and then remove any jammed or partially fed sheets. If you cannot pull a tray fully out, jammed sheets are the most likely cause. To pull a stuck tray fully out, use moderate force.
- When closing the front cover, push the upper side of the cover firmly. After closing the cover, check that the error has cleared.

Paper Misfeed Message (Z)

The "Z Open Frt. Cov and remove paper in Dup.Feed." error message appears when a paper misfeed occurs inside the duplex unit.

CAUTION

- Some of this machine's internal components get very hot. For this reason, take care when removing misfed paper. Not doing so could result in burns.

Important

- The inside of this printer becomes very hot. Before removing paper from the area around the fusing unit, wait until both the fusing unit and the duplex unit have cooled down.
- If a paper misfeed occurs in the duplex unit, open the front cover to remove the misfed paper.

1. Carefully open the printer's front cover by pulling the left and right side levers.

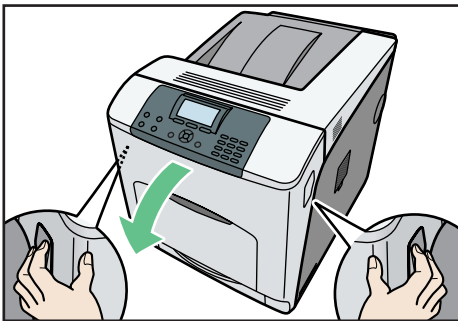

BYK135

2. Tilt the duplex unit backward by carefully raising its front end.

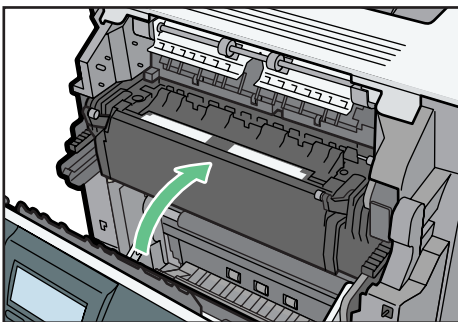

BYK119

3. Carefully remove misfed paper.

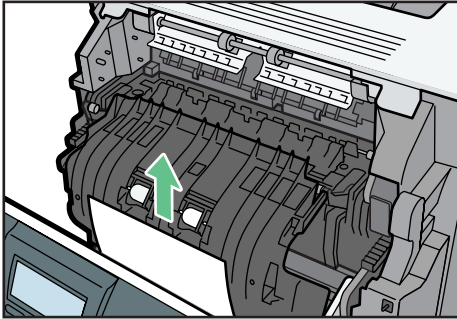

BYK159

4. Carefully close the front cover.

↓ Note

- When closing the front cover, push the upper side of the cover firmly. After closing the cover, check that the error has cleared.

11. Appendix

This section explains maintenance and operation procedures for this printer. It also describes the specifications of the printer and its options.

Moving and Transporting the Printer

WARNING

- If the machine topples, or if a cover or other part gets broken, you must turn the power switch to off and disconnect the power cord plug from the wall outlet. Then contact your service representative and report the problem. Do not use the machine. Doing so could result in fire or electric shock.

CAUTION

- When disconnecting the power cord from the wall outlet, always pull the plug, not the cord. Pulling the cord can damage the power cord. Use of damaged power cords could result in fire or electric shock.

CAUTION

- Unplug the power cord from the wall outlet before you move the machine. While moving the machine, take care that the power cord is not damaged under the machine. Failing to take these precautions could result in fire or electric shock.

CAUTION

- When moving the machine, each person should hold the handles that are located on opposite sides, and then lift it slowly. Lifting it carelessly or dropping it may cause an injury.

CAUTION

- When moving the printer after use, do not take out any of the toners, photo conductor units, nor waste toner bottle to prevent toner spill inside the machine.

Important

- **Be sure to disconnect all cables from the printer before transporting it.**
- **The printer is a piece of precision machinery. Take care to avoid damage during transportation.**
- **If optional paper feed units are attached, remove them from the printer and move them separately.**

Repack the printer using its original packaging for transporting.

Note

- The printer weighs approximately 57 kg (126 lb.).

Moving the Printer a Short Distance

1. Be sure to check the following points:

- The power switch is turned off.
- The power cord is unplugged from the wall outlet.
- The interface cable is unplugged from the printer.

2. If any external options are attached, remove them.

See the relevant sections in this manual and reverse the steps to remove options.

3. Lift the printer with four people by using the inset grips on both side of the printer, and then move it horizontally to the place where you want to install it.

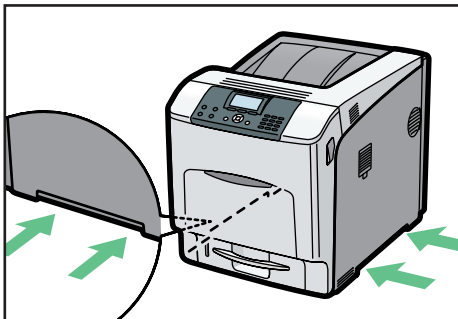

BYK157

When moving the printer, do not hold on the following parts as doing so could cause a malfunction:

- The handle onto the standard paper feed tray.
- The underside of the bypass tray.
- The underside of the box containing the controller board (on the back of the printer).

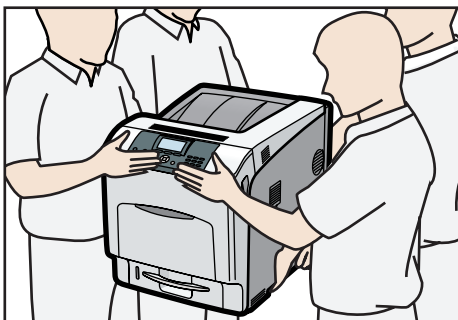

BYK015

4. If you removed options, reattach them.

For details, see the relevant sections in this manual.

Note

- Be sure to keep the printer horizontal while moving it. To prevent toner from being released, move the printer slowly.

Consumables

CAUTION

- Our products are engineered to meet the highest standards of quality and functionality. When purchasing expendable supplies, we recommend using only those specified by an authorized dealer.

Toner (Print Cartridge)

For details about the toner, please visit our Web site or consult an authorized dealer.

Waste Toner Bottle

Name	Average printable number of pages ^{*1}
Waste Toner Bottle SP C430	50,000 pages

^{*1} A4/Letter 5% test chart; 2 pages/job; 50% B&W/50% color printing.

Note

- The actual number of printable pages varies depending on the used paper type and size, and environmental conditions.
- If the waste toner bottles are not changed when necessary, printing will become impossible. We recommend keeping a stock of bottles or purchasing them soon.

Drum Unit

Name	Average printable number of pages ^{*1}
Black Drum Unit SP C430	50,000 pages
Color Drum Unit SP C430	50,000 pages

^{*1} A4/Letter 5% test chart; 2 pages/job; Color Drum Unit: color printing only.

Note

- The actual number of printable pages varies depending on the image volume and density, number of pages to be printed at a time, paper type and paper size used, contents of print images, and environmental conditions such as temperature and humidity.

- If the drum unit is not changed when necessary, print quality is not guaranteed. We recommend keeping a stock of drum unit.
- Drum unit (consumables) are not covered by warranty. However, if there is a problem, contact the store where they were purchased.

Transfer Unit

Transfer Unit SP C430

Name	Average printable number of pages ^{*1}
Intermediate transfer unit	150,000 pages
Transfer roller	150,000 pages

^{*1} A4/Letter 5% test chart, 2 pages/job.

↓ Note

- The actual number of printable pages varies depending on the image volume and density, number of pages to be printed at a time, paper type and paper size used, and environmental conditions such as temperature and humidity.
- If the transfer unit is not changed when necessary, the quality of printing is not guaranteed. We recommend keeping a stock of transfer unit or purchasing one soon.

Fusing Unit

Fusing Unit SP C430

Name	Average printable number of pages ^{*1}
Fusing unit	120,000 pages
Dustproof filter × 3	120,000 pages

^{*1} A4/Letter 5% test chart, 2 pages/job.

↓ Note

- The actual number of printable pages varies depending on the image volume and density, number of pages to be printed at a time, paper type and paper size used, and environmental conditions such as temperature and humidity.
- Fusing unit is not covered by warranty. However, if there is problem, contact the store where they were purchased.

Specifications

Mainframe

Configuration:

Desktop

Print Process:

Laser beam scanning and Electrophotographic printing

Four-drums tandem method

First Print Speed:

Monochrome: 10 seconds or less (A4, 8 1/2 " × 11 " (Letter))

Color: 15 seconds or less (A4, 8 1/2 " × 11 " (Letter))

Note that if the printer has not been used for some time, there may be a short delay before the first page starts printing.

Printing Speed:

Model types	Printing Speed: A4	Printing Speed: 8 1/2 " × 11 " (Letter)
Type 1	maximum 35 pages per minute	maximum 37 pages per minute
Type 2	maximum 40 pages per minute	maximum 42 pages per minute

Resolution:

1200 × 1200 dpi (RPCS, PostScript 3, PCL 6)

600 × 600 dpi (RPCS, PostScript 3, PCL 6, PCL 5c)

Paper Size:

For details, see p. 119 "Supported Paper for Each Tray".

Paper Weight:

For details, see p. 119 "Supported Paper for Each Tray".

Media Type:

For details, see p. 123 "Types of Paper and Other Media".

Paper Output Capacity:



Standard 500 sheets (80 g/m², 20 lb.)

Paper Input Capacity

Tray	Paper capacity
standard paper feed tray	550 sheets ^{*1}
Bypass Tray	100 sheets ^{*1}
Optional Paper Feed Units	550 sheets ^{*1} × 3

* 1 Paper weight: 80 g/m² (20 lb. bond)

Power Source:

-  **Region A** (mainly Europe and Asia)
220-240 V, 50/ 60 Hz, 8 A or more
-  **Region B** (mainly North America)
120-127 V, 60 Hz, 12 A or more

Power Consumption:

 **Region A** (mainly Europe and Asia)

Printing	1650 W or less
Energy saver mode	110 W or less
Auto off mode	6 W or less

 **Region B** (mainly North America)

Printing	1600 W or less
Energy saver mode	110 W or less
Auto off mode	6 W or less

Warm-up Time:

Less than 50 seconds (23 °C, 71.6 °F)

Dimensions (W × D × H):

444 × 658 × 490 mm (17.5 × 26 × 19.3 inches) ^{*1}

* 1 Printer only (tray not extended)

Weight:

Approximately 57 kg (126 lb.) (Toner and power cord included)

Noise Emission: *1

- Sound Power Level (During Printing)

Model types	Monochrome	Color
Type 1	68.3 dB (A)	68.5 dB (A)
Type 2	70 dB (A)	70 dB (A)

- Sound Pressure Level (During Printing) *2

Model types	Monochrome	Color
Type 1	62.3 dB (A)	62.5 dB (A)
Type 2	64 dB (A)	64 dB (A)

*1 The preceding measurements made in accordance with ISO7779 are actual values.

*2 Measured at the position of a bystander.

Memory:

Model types	Memory
Type 1	384 MB (Standard), up to 768 MB (with the optional memory unit)
Type 2	768 MB (Standard)

Hard Disk:

Model types	Hard Disk
Type 1	80 GB (Optional)
Type 2	80 GB (Standard)

Note

- Storage capacity is subject to change without prior notice.

Interfaces:

Standard:

- Ethernet (10BASE-T/100BASE-TX)
- USB 2.0
To use USB 2.0, a USB computer port and cable that support USB 2.0 are required.
- USB Host

Optional:

- IEEE 802.11 a/b/g (Wireless LAN)
- Parallel (Bidirectional IEEE 1284)
- Gigabit Ethernet (1000BASE-T)

Printer Language:

RPCS, PCL5c/PCL6, PS3/PDF

Fonts:

PCL 5c/PCL 6

45 fonts, 13 International fonts

PostScript 3, PDF

136 fonts (Type 2:24, Type 14:112)

Network:

Topology: The physical or logical layout of the nodes (devices) in a network. (10BASE-T/100BASE-TX)

Protocol: TCP/IP, IPX/SPX, AppleTalk

Options

Paper Feed Unit PB1020

Paper Size:

For details, see p. 119 "Supported Paper for Each Tray".

Dimensions (W × D × H):

444 × 590 × 140 mm (17.5 × 23.2 × 5.6 inches)

Paper weight:

52 - 220 g/m², (14 - 59 lb.)

Weight:

Less than 12 kg (26.5 lb.)

Hard Disk Drive Option Type 5000 (Type 1 model only)

Storage Capacity (Formatted):

80 GB

Note

- Storage capacity is subject to change without prior notice.

Specifications:

- Spooling print data to collate
- Storing/Spooling Sample Print/Locked Print/Hold Print/Stored Print data
- Storing PostScript fonts
- Storing log data

Memory Unit Type G 256 MB (Type 1 model only)

Module Type:

DIMM (Dual-in-line Memory Module)

Memory Type:

DDR-SDRAM (Double Data Rate Synchronous Dynamic RAM)

Number of Pins:

200 pins

Memory Unit Type I 512 MB (Type 1 model only)

Module Type:

DIMM (Dual-in-line Memory Module)

Memory Type:

DDR-SDRAM (Double Data Rate Synchronous Dynamic RAM)

Number of Pins:

200 pins

11

Gigabit Ethernet Board Type A

Interface Connector:

Ethernet (10BASE-T, 100BASE-TX, 1000BASE-T)

USB 2.0

To use USB 2.0, a USB computer port and cable that support USB 2.0 are required.

Data Transmission Speed: Ethernet: 10 Mbps, 100 Mbps, 1000 Mbps

USB: 480 Mbps (High speed: USB 2.0), 12Mbps (Full speed)

Protocol:

TCP/IP, IPX/SPX, AppleTalk

Maximum Length of Cable Between Devices:

Ethernet: 100 m

USB: 5 m

IEEE 802.11 a/g Interface Board Type M  Region **A (mainly Europe and Asia)****Transmission Specification:**

Based on IEEE 802.11 a/b/g (Wireless LAN)

Data Transfer Speed:

Auto select from the following speed:

1 Mbps, 2 Mbps, 5.5 Mbps, 6Mbps, 9Mbps, 11 Mbps, 12Mbps, 18Mbps, 24Mbps, 36Mbps, 48Mbps, 54Mbps

Frequency Range:

2412 to 2472 MHz (Channels 1 to 13)

5180 to 5320 MHz (Channels 36 to 64)

Transmission Mode:

- Ad hoc
- infrastructure mode

IEEE 802.11 a/g Interface Board Type L  Region **B (mainly North America)****Transmission Specification:**

Based on IEEE 802.11 a/b/g (Wireless LAN)

Data Transfer Speed:

Auto select from the following speed:

1 Mbps, 2 Mbps, 5.5 Mbps, 6Mbps, 9Mbps, 11 Mbps, 12Mbps, 18Mbps, 24Mbps, 36Mbps, 48Mbps, 54Mbps

Frequency Range:

2412 to 2462 MHz (1 to 11 channels)

5180 to 5320 MHz (Channels 36 to 64)

Transmission Mode:

- Ad hoc
- infrastructure mode

IEEE 1284 Interface Board Type A

Transmission Specification:

IEEE 1284

Required Cable:

Standard IEEE 1284-compliant Micro Getronics 36-pin cable

INDEX

A

Adding toner.....	163
Additional troubleshooting.....	215
Adjusting the color registration.....	183
Adjusting the paper type.....	195
Alert indicator.....	24
Available options.....	59

B

Browser.....	14
Bypass tray.....	17, 121, 138, 146, 147, 149, 151, 152
Bypass tray extension.....	17

C

Camera direct print card.....	82
CAUTION label.....	9
Cautions when cleaning.....	176
CD-ROM.....	14
Certificate.....	115
Checking the contents of the box.....	36
Checking the port connection.....	205
Cleaning the paper feed roller.....	177
Cleaning the registration roller.....	180
Clear key.....	26
Coated paper (glossy thick).....	129
Coated paper (glossy).....	128
Coated paper (matted thick).....	130
Coated paper (matted).....	129
Color calibration sample sheet.....	188
Color gradation.....	185
Consumables.....	230
Control panel.....	17, 23
Controller board.....	19, 62
Custom size paper.....	142, 149

D

Data in indicator.....	24
Data overwrite security unit.....	82
Data storage card.....	82
Device certificate.....	115
DHCP.....	96
Digital camera connection.....	90
Display.....	24

Display panel.....	25
Drum unit.....	21, 168, 230
Dustproof filter.....	231
Dustproof filters.....	174

E

ELP-NX card.....	56
Entering character.....	26
Envelopes.....	133
Error message.....	197
Escape key.....	23, 26
Ethernet.....	93
Ethernet cable connection.....	85
Ethernet configuration.....	93
Ethernet port.....	19
Ethernet speed.....	99
Exterior.....	17

F

Front cover.....	17
Front cover (A) open levers.....	19
Front cover open levers.....	18
Fusing unit.....	22, 174, 231

G

Gigabit Ethernet board.....	75
Gradation correction sheet.....	188
Gradation correction value.....	185, 190
Guide to the printer.....	17, 19, 21, 23

H

hard disk.....	70
HDD encryption unit.....	82
How to enter character.....	27
How to read this manual.....	6
HTML.....	14

I

IEEE 1284 interface board.....	79, 92
IEEE802.1X authentication.....	101
Inner cover.....	21
Installing options.....	59, 60
Installing the ELP-NX card.....	56
Installing the toner.....	43
Interface units.....	75

Interior.....	21
Intermediate transfer unit.....	231
IP address.....	93

J

Job reset key.....	23
--------------------	----

L

Label paper.....	127
LED lamps.....	87
Left cover.....	19
Letterhead.....	126
List of options.....	13
Loading envelopes.....	152, 154
Loading paper.....	47, 138

M

Machine types.....	7
Manuals.....	14
Manuals for this printer.....	11
Menu key.....	23
Middle thick.....	124
Model-specific information.....	7
Moving and transporting.....	227
Moving the printer a short distance.....	228

N

NetWare.....	98
Network.....	93, 104
Network setting.....	98
No DHCP.....	94
Number keys.....	24, 26

O

OHP transparencies.....	126
OK key.....	24, 26
Operational status or messages.....	25
Option.....	25
Optional interface board slots.....	19
Optional paper feed tray.....	119, 138
Order of option installation.....	59
Other printing problems.....	207

P

Panel tone.....	203
-----------------	-----

Paper feed roller.....	18, 177
Paper feed unit.....	47, 63, 138
Paper misfeed message (A).....	218
Paper misfeed message (B) (C).....	219
Paper misfeed message (Y).....	222
Paper misfeed message (Z).....	224
Paper not supported by this printer.....	135
Paper recommendations.....	123
Paper size.....	147
Paper type.....	144
Paper weight and capacity.....	122
Parallel cable connection.....	92
Place to install.....	32
Plain paper.....	123
Power connector.....	20
Power indicator.....	23
Power switch.....	19
Power switch symbols.....	10
Preprinted paper.....	132
Print area.....	136
Print test sheet.....	192
Printer does not print.....	204
Printer set up procedure.....	31
Printing position.....	192
Prt.jobs.....	25

R

Re-installing the controller board.....	62
Rear view.....	19
Recycled paper.....	133
Registration roller.....	180
Removing misfed paper.....	217
Removing the packaging materials.....	38
Replacing the drum unit.....	168
Replacing the dustproof filters.....	174
Replacing the fusing unit.....	174
Replacing the transfer roller.....	170
Replacing the transfer unit.....	170
Replacing the waste toner bottle.....	172

S

Scroll keys.....	23, 26
SD card slots.....	20
SDRAM module.....	67

Security.....	109
Selecting the display language.....	54
Selection keys.....	23, 26
Setting a paper size.....	140
Setting the paper size automatically.....	141
Shutdown.....	50
Site certificate.....	115
Special paper.....	132
Specifications.....	232
Specifying a paper type.....	151
SSID.....	106
Standard paper feed tray.....	17, 47, 119, 138, 154
Standard tray.....	18
Status message.....	197
Storing paper.....	123
Supplies.....	25
Supported paper.....	119
Suspend/resume key.....	23
Switch functions key.....	23
Switching between paper trays.....	157

T

Test printing.....	55
The remaining paper indicator.....	17
Thick paper.....	125
Thin paper.....	125
Toner.....	21, 43, 163, 230
Top cover.....	18
Transfer roller.....	22, 170, 231
Transfer unit.....	21, 170, 231
Tray 1.....	17, 47
Tray priority.....	157
Troubleshooting.....	197
Turning off the power.....	51
Turning on the power.....	50
Turning the power On and Off.....	50
Types of paper and other media.....	123

U

USB cable connection.....	89
USB port A.....	19
USB port B.....	19
User paper type.....	159, 160, 161

V

Vents.....	18, 19
VM card.....	82

W

WARNING label.....	9
Waste toner bottle.....	21, 172, 230
Waterproof paper.....	131
Web Image Monitor.....	159
WEP key.....	109
Wireless LAN.....	104, 107, 108, 109
Wireless LAN configuration.....	104
Wireless LAN connectivity.....	107
Wireless LAN interface unit.....	77
WPA.....	110, 115, 117
WPA2.....	110, 115, 117

MEMO

MEMO

MEMO

Trademarks

Adobe, Acrobat, Acrobat Reader, PostScript, and Reader are registered trademarks of Adobe Systems Incorporated.

Apple, Macintosh, and Mac OS are trademarks of Apple Computer, Inc., registered in the U.S. and other countries.

IPS is a trademark or registered trademark of Zoran Corporation and/ or its subsidiaries in the United States or other countries.

Microsoft®, Windows®, Windows Server®, and Windows Vista® are registered trademarks of Microsoft Corporation in the United States and/or other countries.

Monotype is a registered trademark of Monotype Imaging, Inc.

PCL® is a registered trademark of Hewlett-Packard Company.

PictBridge is a trademark.

UNIX is a registered trademark of The Open Group.

Other product names used herein are for identification purposes only and might be trademarks of their respective companies. We disclaim any and all rights to those marks.

The proper names of the Windows operating systems are as follows:

* The product names of Windows 2000 are as follows:

- Microsoft® Windows® 2000 Professional
- Microsoft® Windows® 2000 Server
- Microsoft® Windows® 2000 Advanced Server
- Microsoft® Windows® 2000 Datacenter Server

* The product names of Windows XP are as follows:

- Microsoft® Windows® XP Professional
- Microsoft® Windows® XP Home Edition
- Microsoft® Windows® XP Media Center Edition
- Microsoft® Windows® XP Tablet PC Edition
- Microsoft® Windows® XP Professional x 64 Edition

* The product names of Windows Vista are as follows:

- Microsoft® Windows Vista® Ultimate
- Microsoft® Windows Vista® Business
- Microsoft® Windows Vista® Home Premium
- Microsoft® Windows Vista® Home Basic
- Microsoft® Windows Vista® Enterprise

* The product names of Windows Server 2003 are as follows:

- Microsoft® Windows Server® 2003 Standard Edition
- Microsoft® Windows Server® 2003 Enterprise Edition
- Microsoft® Windows Server® 2003 Web Edition
- Microsoft® Windows Server® 2003 Datacenter Edition

* The product names of Windows Server 2003 R2 are as follows:

- Microsoft® Windows Server® 2003 R2 Standard Edition
- Microsoft® Windows Server® 2003 R2 Enterprise Edition
- Microsoft® Windows Server® 2003 R2 Datacenter Edition

* The product names of Windows Server 2008 are as follows:

- Microsoft® Windows Server® 2008 Foundation
- Microsoft® Windows Server® 2008 Standard
- Microsoft® Windows Server® 2008 Enterprise
- Microsoft® Windows Server® 2008 Datacenter





Operating Instructions Software Guide



-
- 1** Preparing for Printing
 - 2** Printing Documents
 - 3** Printing Stored Documents
 - 4** Direct Printing from a Digital Camera (PictBridge)
 - 5** Making Printer Settings Using the Control Panel
 - 6** Monitoring and Configuring the Printer
 - 7** Using a Printer Server
 - 8** Mac OS Configuration
 - 9** Appendix

Introduction

This manual contains detailed instructions and notes on the operation and use of this machine. For your safety and benefit, read this manual carefully before using the machine. Keep this manual in a handy place for quick reference.

Do not copy or print any item for which reproduction is prohibited by law.

Copying or printing the following items is generally prohibited by local law:

bank notes, revenue stamps, bonds, stock certificates, bank drafts, checks, passports, driver's licenses.

The preceding list is meant as a guide only and is not inclusive. We assume no responsibility for its completeness or accuracy. If you have any questions concerning the legality of copying or printing certain items, consult with your legal advisor.

Important

Contents of this manual are subject to change without prior notice.

In no event will the company be liable for direct, indirect, special, incidental, or consequential damages as a result of handling or operating the machine.

For good print quality, the manufacturer recommends that you use genuine toner from the manufacturer.

The manufacturer shall not be responsible for any damage or expense that might result from the use of parts other than genuine parts from the manufacturer with your office products.

Some illustrations in this manual might be slightly different from the machine.

Certain options might not be available in some countries. For details, please contact your local dealer.

TABLE OF CONTENTS

How to Read This Manual.....	8
Symbols.....	8
Model-Specific Information.....	9
Machine Types.....	9
Manuals for This Printer.....	11
List of Options.....	13
Using Keys.....	14

1. Preparing for Printing

Before Using the Printer.....	17
Drivers and Utilities.....	17
Using User Authentication.....	17
Accessing the Extended Features.....	18
Software Included on the CD-ROM.....	19
Viewing the Contents of the CD-ROM.....	19
Printer Drivers for This Printer.....	19
Downloading Utility Software.....	21
SmartDeviceMonitor for Admin.....	21
DeskTopBinder.....	21
SmartDeviceMonitor for Client.....	22
If User Authentication is Specified.....	23
User Code Authentication (Using the Printer Driver).....	23
Log in (Using the Control Panel).....	23
Log out (Using the Control Panel).....	24
Log in (Using the Printer Driver).....	24
Log in (Using Web Image Monitor).....	25
Log out (Using Web Image Monitor).....	25

2. Printing Documents

Displaying the Printer Driver Settings Screen.....	27
Making Printer Default Settings - The Printer Properties.....	27
Making Printer Default Settings - Printing Preferences.....	27
Making Printer Settings from an Application.....	28
Making Printer Settings - One Click Presets.....	29
Frequently Used Print Methods.....	30

Standard Printing.....	30
Printing on Both Sides of Sheets.....	32
Combining Multiple Pages into Single Page.....	35
Advanced Printing.....	39
Menu Names and Brief Overview of Each Function.....	39
Specifying Printer Driver or Print Command Priority.....	40
Printing on Cover Sheet.....	42
Inserting Slip Sheets.....	43
Printing with Watermarks.....	45
Collate Function.....	47
Spool Printing.....	48
Setting Spool Printing.....	48
Viewing or Deleting spooled jobs using Web Image Monitor.....	49
Printing a PDF File Directly.....	50
Using DeskTopBinder Lite.....	50
PDF Direct Printing Using Function Palette.....	51
PDF Direct Print Properties.....	52
Using Commands to Print.....	53
Specifying the Classification Code for a Print Job.....	55
Using the Virtual Printer.....	57
Adding a Virtual Printer.....	57
Changing a Virtual Printer Configuration.....	58
Confirming a Virtual Printer Configuration.....	58
Deleting a Virtual Printer.....	59
Printing Using a Virtual Printer.....	60
If Errors Occur with the Specified Paper Size and Type.....	61
Changing the Paper Tray Settings.....	61
Printing from a Selected Tray.....	62
Canceling a Print Job.....	62
Proceeding with Printing using the Bypass Tray.....	63
3. Printing Stored Documents	
Using the Print Job Function.....	65
Print Job Screen.....	65

Printing from the Print Job Screen.....	68
Sample Print.....	68
Locked Print.....	71
Hold Print.....	75
Stored Print.....	78
Printing from the User ID Screen.....	82
Printing the Selected Print Job.....	82
Printing All Print Jobs.....	83
Canceling a Print Job.....	85
Canceling a Print Job Using the Control Panel.....	85
Windows - Canceling a Print Job from the computer.....	85
Mac OS - Canceling a Print Job from the computer.....	86

4. Direct Printing from a Digital Camera (PictBridge)

What is PictBridge?.....	87
PictBridge Printing.....	88
What Can be Done on This Printer.....	89
Index Printing.....	89
Trimming.....	90
Date and File Name Printing.....	91
Paper Size.....	91
Image Print Size.....	91
Multi-Image-Layout.....	92
Duplex Printing.....	94
Printing Quality.....	94
Color Matching.....	94
Paper Type Specification.....	94
Form Printing.....	95
Toner Saving.....	95
Camera Memo Printing.....	95
Exiting PictBridge.....	96
When PictBridge Printing Does Not Work.....	97
Other Reference Information.....	98

5. Making Printer Settings Using the Control Panel

Menu Chart.....	99
Memory Erase Status Menu.....	104
Paper Input Menu.....	105
Paper Input Menu Parameters.....	105
Changing the Paper Input Menu.....	107
Maintenance Menu.....	110
Maintenance Menu Parameters.....	110
Changing the Maintenance Menu.....	118
List/Test Print Menu.....	119
List/Test Print Menu Parameters.....	119
Printing a Configuration Page.....	119
Interpreting the Configuration Page.....	120
System Menu.....	124
System Menu Parameters.....	124
Changing the System Menu.....	128
Print Settings Menu.....	130
Print Settings Menu Parameters.....	130
Changing the Print Settings Menu.....	138
Security Options Menu.....	140
Security Options Menu Parameters.....	140
Changing the Security Options Menu.....	143
Host Interface Menu.....	145
Host Interface Menu Parameters.....	145
Changing the Host Interface Menu.....	150
Language Menu.....	152
Language Menu Parameters.....	152
Changing the Language Menu.....	152
Options Menu.....	153
Options Menu Parameters.....	153
Checking the Error Log.....	153

6. Monitoring and Configuring the Printer

Using Web Image Monitor.....	155
------------------------------	-----

Introduction to Web Image Monitor.....	155
Displaying Top Page.....	156
When User Authentication is Set.....	158
About Menu and Mode.....	158
Access in the Administrator Mode.....	159
Displaying Web Image Monitor Help.....	160
Registering Classification Codes.....	162
Configuring Classification Codes.....	163
Address Book Backup and Restore.....	164
Backing Up Address Book Data.....	164
Restoring Address Book Data.....	164
Using SmartDeviceMonitor for Admin.....	166
When Using IPP with SmartDeviceMonitor for Client.....	167
Printer Status Notification by E-Mail.....	168
Auto E-mail Notification.....	169
On-demand E-mail Notification.....	170
Mail Authentication.....	170
Sending On-demand E-mail.....	171
7. Using a Printer Server	
Preparing Printer Server.....	175
Printing notification via SmartDeviceMonitor for Client.....	175
Using NetWare.....	177
Setting Up as a Print Server (NetWare 3.x).....	177
Setting Up as a Print Server (NetWare 4.x, 5 / 5.1, 6 / 6.5).....	179
Using Pure IP in the NetWare 5 / 5.1 or 6 / 6.5 Environment.....	180
Setting Up as a Remote Printer (NetWare 3.x).....	182
Setting Up as a Remote Printer (NetWare 4.x, 5 / 5.1, 6 / 6.5).....	183
8. Mac OS Configuration	
Using PostScript 3.....	187
Job Type.....	187
Paper Type.....	200
Resolution.....	201
Fit to Paper.....	201

Economy Color.....	201
Image Smoothing.....	202
Color Mode.....	202
Gradation.....	203
Color Setting.....	203
Color Profile.....	204
Dithering.....	204
Gray Reproduction.....	205
Black Over Print.....	205
Separate into CMYK.....	206
CMYK Simulation Profile.....	206
Rotate by 180 degrees.....	206
Orientation Override.....	206
Watermark.....	207
Watermark Text.....	207
Watermark Font.....	207
Watermark Size.....	207
Watermark Angle.....	207
Watermark Style.....	208

9. Appendix

When Using Windows Terminal Service/Citrix Presentation Server/Citrix XenApp.....	209
Operating Environment.....	209
Supported Printer Drivers.....	209
Limitations.....	209
Using DHCP.....	211
Using AutoNet.....	211
Configuring the WINS Server.....	212
Using Web Image Monitor.....	212
Using telnet.....	212
Using the Dynamic DNS Function.....	213
Updating.....	213
DNS Servers Targeted for Operation.....	214
DHCP Servers Targeted for Operation.....	214

Setting the Dynamic DNS Function.....	214
Precautions.....	216
Connecting a Dial-Up Router to a Network.....	216
When the Wireless LAN Interface Unit Is Installed.....	216
Copyright Information about Installed Applications.....	218
expat.....	218
NetBSD.....	218
FreeBSD 4.6.2/netipx.....	227
Sablotron(Version 0.82).....	228
JPEG LIBRARY.....	228
SASL.....	228
RSA BSAFE®.....	229
Open SSL.....	229
Open SSH.....	231
Open LDAP.....	235
Heimdal.....	236
IPS™ print language emulations.....	237
AppleTalk.....	237
SPX/IPX.....	237
WPA Supplicant.....	237
nana.....	238
ILU.....	238
racoona.....	239
TrouSerS.....	239
Samba.....	242
INDEX.....	251

How to Read This Manual

Symbols

This manual uses the following symbols:

Important

Indicates points to pay attention to when using the machine, and explanations of likely causes of paper misfeeds, damage to originals, or loss of data. Be sure to read these explanations.

Note

Indicates supplementary explanations of the machine's functions, and instructions on resolving user errors.

Reference

This symbol is located at the end of sections. It indicates where you can find further relevant information.

[]

Indicates the names of keys on the machine's display or control panels.

 **Region A** (mainly Europe and Asia)

 **Region B** (mainly North America)

Differences in the functions of Region A and Region B models are indicated by two symbols. Read the information indicated by the symbol that corresponds to the region of the model you are using. For details about which symbol corresponds to the model you are using, see "Model-Specific Information".

Model-Specific Information

This section explains how you can identify the region your machine belongs to.

There is a label on the rear of the machine, located in the position shown below. The label contains details that identify the region your machine belongs to. Read the label.

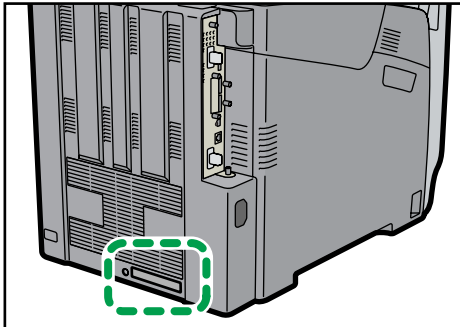

BYK003

The following information is region-specific. Read the information under the symbol that corresponds to the region of your machine.

 **Region A** (mainly Europe and Asia)

If the label contains the following, your machine is a region A model:

- CODE XXXX -22, -27
- 220-240V

 **Region B** (mainly North America)

If the label contains the following, your machine is a region B model:

- CODE XXXX -11, -17
- 120-127V

 **Note**

- Dimensions in this manual are given in two units of measure: metric and inch. If your machine is a Region A model, refer to the metric units. If your machine is a Region B model, refer to the inch units.

Machine Types

This printer comes in two models that have different printing speeds.

When describing procedures that are model-specific, this manual refers to the different printer models as Type 1 or Type 2. The following table describes the model types.

Model types

Model types	Printing Speed	Hard Disk
Type 1	maximum 35 pages per minute (A4 [□])	Optional
Type 2	maximum 40 pages per minute (A4 [□])	Standard

Manuals for This Printer

Read this manual carefully before you use this printer.

Refer to the manuals that are relevant to what you want to do with the printer.

Important

- Media differ according to manual.
- The printed and electronic versions of a manual have the same contents.
- Adobe Acrobat Reader/Adobe Reader must be installed in order to view the manuals as PDF files.
- A Web browser must be installed in order to view the html manuals.

Safety Information

Contains information about safe usage of this printer.

To avoid injury and prevent damage to the printer, be sure to read this.

Quick Installation Guide

Contains procedures for removing the printer from its box, and connecting it to a computer.

Hardware Guide

Contains information about paper and procedures such as installing options, replacing consumables, responding to error messages, and resolving jams.

Driver Installation Guide

Contains procedures for installing the printer driver. This manual is included on the driver CD-ROM.

Software Guide (This manual)

Contains information about using this printer, its software, and its security functions.

Security Guide

This manual is for administrators of the printer. It explains security functions that you can use to prevent unauthorized use of the printer, data tampering, or information leakage. Be sure to read this manual when setting the enhanced security functions, or user and administrator authentication.

Enhanced Locked Print NX User's Guide (Type 2 model only)

This manual is for ordinary users (non-administrators) of Enhanced Locked Print NX. It explains the procedures for configuring authentication using the printer driver, and logging on to Enhanced Locked Print NX to print or delete jobs.

Enhanced Locked Print NX Administrator's Guide (Type 2 model only)

This manual is for administrators of Enhanced Locked Print NX. It explains the procedures for using the management tool to configure system and option settings, and manage print jobs.

This manual is provided in English only.

VM Card Extended Feature Settings Web Reference

Contains information about setting up the extended features settings using Web Image Monitor.

UNIX Supplement

Contains information about the usage of commands to operate this printer.

To obtain the "UNIX Supplement", visit our Web site or consult an authorized dealer.

This manual includes explanations of functions and settings that might not be available on this printer.

This manual is provided in English only.

Note



- Manuals provided are specific to printer types.
- The following software products are referred to as using general names:

Product name	General name
DeskTopBinder Lite and DeskTopBinder Professional ^{*1}	DeskTopBinder

*1 Optional

List of Options

This section provides a list of options for this printer, and how they are referred to as in this manual.

Option List	Referred to as
Paper Feed Unit PB1020	Paper feed unit
Hard Disk Drive Option Type 5000	Hard disk
Memory Unit Type G 256 MB	SDRAM module
Memory Unit Type I 512 MB	SDRAM module
 Region B IEEE 802.11a/g Interface Unit Type L	Wireless LAN interface unit
 Region A IEEE 802.11a/g Interface Unit Type M	Wireless LAN interface unit
IEEE 1284 Interface Board Type A	IEEE 1284 interface board
Camera Direct Print Card Type H	Camera direct print card
Data Overwrite Security Unit Type K	Data overwrite security unit
HDD Encryption Unit Type D	HDD encryption unit
SD card for NetWare printing Type D	NetWare card
VM Card Type O	VM card

 **Note**

- For details about the specifications of each option, see "Specifications", Hardware Guide.

Using Keys

This section explains names and usage of the parts of the control panel.

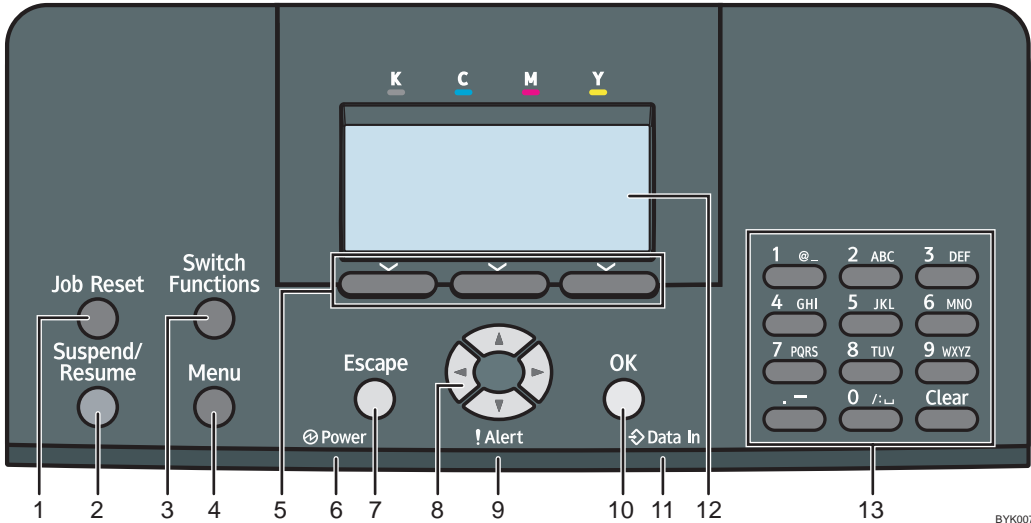

1. [Job Reset] Key

When the printer is online, press this key to cancel an ongoing print job.

2. [Suspend/Resume] Key

Press this to suspend a print job. This key remains lit as long as the job is suspended. To resume the job, press this key again.

3. [Switch Functions] Key

Press this key to switch between the operation screen of the printer function and the function screens of the extended features currently in use.

4. [Menu] Key

Press this key to configure and check the current printer settings.

5. Selection Keys

Correspond to the function items at the bottom line on the display.

Example: When this manual instructs you to press [Option], press the selection key on the left below the initial screen.

6. Power Indicator

Lights up when the printer is ready to receive data from a computer. Flashes when the printer is warming up or receiving data. It is unlit when the power is off or while the printer is in energy saver mode.

7. [Escape] Key

Press this key to return to the previous display.

8. Scroll Keys

Press these keys to move the cursor in each direction.

When the [▲] [▼] [◀] [▶] keys appear in this manual, press the scroll key of the same direction.

9. Alert Indicator

Lights up or flashes when a printer error occurs.

Steady red: printing is not possible, or is possible but print quality cannot be ensured.

Flashing yellow: the printer will soon require maintenance or a replacement consumable such as toner.

Follow the instructions that appear on the display.

10. [OK] Key

Use this key to confirm settings, or setting values, or move to the next menu level.

11. Data In Indicator

Flashes when the printer is receiving data from a computer. The data in indicator is lit if there is data to be printed.

12. Display

Displays current printer status and error messages.

Entering energy saver mode turns off the back light. For details about energy saver mode, see "System Menu".

13. Number Keys

Use these to enter characters or numbers.

Reference

- p.124 "System Menu"



1. Preparing for Printing

This chapter explains the preparation procedure to use this printer.

Before Using the Printer

This section explains the settings, procedures, items, and other information on which the user is recommended to check before you can use this printer.

Drivers and Utilities

To use this printer, you must install its driver on your computer.

For details about the procedure for installing the printer driver, see Driver Installation Guide on the driver CD-ROM.

This printer comes with two CD-ROMs: a driver CD-ROM and a manual CD-ROM.

For details about the contents of the drivers CD-ROM, see "Software Included on the CD-ROM".

Besides drivers, there are other useful utilities available for this printer.

For details about these utilities, see "Downloading Utility Software".

Reference

- p.19 "Software Included on the CD-ROM"
- p.21 "Downloading Utility Software"

Using User Authentication

Using authentication, administrators manage the printer and its users. To enable authentication, information about both administrators and users must be registered in order to authenticate users via their login user names and passwords.

There are four kinds of administrator. Each administrator manages a specific area of printer usage, such as settings or user registration.

Access limits for each user are specified by the administrator responsible for user access to printer functions and documents and data stored in the printer.

When authentication is set on the printer, see "If User Authentication is Specified".

Reference

- p.23 "If User Authentication is Specified"

Accessing the Extended Features

1

Various functions besides printing can be accessed using the [Switch Functions] key on this printer.

Use the following procedure to switch between applications. For details about using ELP NX, see Enhanced Locked Print NX User's Guide.

1. Press the [Switch Functions] key.

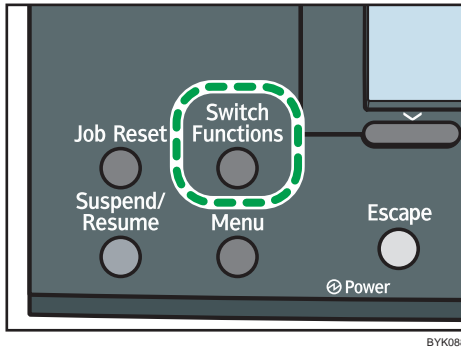

2. Press the [▼] or [▲] key to select the [Java™/X].
3. Press the [OK] key.
4. If more than one extended feature is installed, use the [▼] or [▲] key to select the extended feature you want to access.
5. Press the [OK] key.

↓ Note

- On Type 1 models, function switching is possible only when the VM card is installed.
- This manual explains the procedure for changing settings when 'Printer' is selected as the application.

Software Included on the CD-ROM

This section explains the software included on the "Printer Drivers" CD-ROM that comes with this printer.

1

Viewing the Contents of the CD-ROM

This section explains how to view the contents of the CD-ROM.

1. **Insert the CD-ROM into the CD-ROM drive.**

The installer starts.

2. **Select a language, and then click [OK].**

3. **Click [Browse This CD-ROM].**

Explorer starts and displays the contents of the CD-ROM.

Printer Drivers for This Printer

This section explains printer drivers for this printer.

★ Important

- You can install the PCL printer drivers (PCL 5c and PCL 6), and the PostScript3 printer driver from the CD-ROM provided with this printer or download them from the manufacturer's Web site. If your operating system is Windows XP x64/Vista x64, Windows Server 2003 x64/2003 R2 x64/2008 x64, you must download the printer drivers from the manufacturer's Web site. Select this printer and the operating system you are using, and then download them.

Printing requires installation of a printer driver for your operating system. The following drivers are included on the CD-ROM labeled "Printer Drivers".

Operating System	PCL 5c	PCL 6	PostScript 3
Windows 2000 ^{*1}	OK	OK	OK
Windows XP ^{*2}	OK	OK	OK
Windows Vista ^{*3}	OK	OK	OK
Windows Server 2003 ^{*4}	OK	OK	OK
Windows Server 2008 ^{*5}	OK	OK	OK
Mac OS X ^{*6}	—	—	OK

- *1 Microsoft Windows 2000 Professional /Microsoft Windows 2000 Server/Microsoft Windows 2000 Advanced Server
- *2 Microsoft Windows XP Professional/Microsoft Windows XP Home Edition/Windows XP Media Center Edition / Windows XP Tablet PC Edition
- *3 Microsoft Windows Vista Ultimate/Microsoft Windows Vista Enterprise/Microsoft Windows Vista Business/Microsoft Windows Vista Home Premium/Microsoft Windows Vista Home Basic
- *4 Microsoft Windows Server 2003 Standard Edition/Microsoft Windows Server 2003 Enterprise Edition/Microsoft Windows Server 2003 R2 Standard Edition/Microsoft Windows Server 2003 R2 Enterprise Edition/
- *5 Microsoft Windows Server 2008 Standard /Microsoft Windows Server 2008 Enterprise/Microsoft Windows Server 2008 Foundation/
- *6 Mac OS X 10.2 later

PCL Printer Drivers

Two kinds of PCL printer drivers (PCL 5c and PCL 6) are included. These drivers allow your computer to communicate with this printer using a printer language.

PS Printer Driver

PostScript printer driver allows the computer to communicate with the printer using a printer language.

PPD files

PPD files allow the printer driver to enable specific printer functions.

Note

- Some applications may require installation of the PCL 5c printer driver.
- For details about installation procedure, see Driver Installation Guide.

Downloading Utility Software

This section explains the utility software for this printer.

1

SmartDeviceMonitor for Admin

This section describes the functions available with SmartDeviceMonitor for Admin.

SmartDeviceMonitor for Admin is an application that uses TCP/IP to monitor network printers. It can monitor multiple network printers using IP address. We recommend that network administrators use this application.

You can use SmartDeviceMonitor for Admin through Web Image Monitor to easily check the following:

- Levels of supplies such as paper or toner
- Results of print jobs executed from the computer

SmartDeviceMonitor for Admin with full functionality can be purchased from your local dealer. Contact your local dealer for information on purchasing the software.

SmartDeviceMonitor for Admin with limited functionality is available as a free download. Contact your local dealer for information on downloading the software.

↓ Note

- For details about the functionality, see the manual for SmartDeviceMonitor for Admin.

DeskTopBinder

This section describes the functions available with DeskTopBinder.

DeskTopBinder is to be installed on the client computers for integration and management of various kinds of files such as scan files, files created with applications, and existing scan files. This software allows you to use various functions for stored scan files such as viewing stored files. Also, with the ScanRouter delivery software, you can view the files stored in in-trays of the delivery server, or use other functions for stored files.

DeskTopBinder Professional provides the full functionality of the software. Contact your local dealer for information on purchasing the software.

DeskTopBinder Lite with limited functionality is available as a free download. Contact your local dealer for information on downloading the software.

↓ Note

- For details about the functionality, see Help of DeskTopBinder.

SmartDeviceMonitor for Client

1

This section describes the functions available with SmartDeviceMonitor for Client.

SmartDeviceMonitor for Client allows you to manage and print various data such as files created with an application, images scanned with a scanner, and existing images as one document.

SmartDeviceMonitor for Client is available as a free download. Contact your local dealer for information on downloading the software.

 **Note**

- For details about the functionality, see Help of SmartDeviceMonitor for Client.

If User Authentication is Specified

When user authentication (User Code Authentication, Basic Authentication, Windows Authentication, LDAP Authentication, or Integration Server Authentication) is specified, an authentication screen appears whenever a user attempts to use the machine. The printer is usable only if the user enters a valid user name and password on this screen.

When authentication is specified, users must log in to use the printer and log out when they have finished using it. Logging out prevents unauthorized usage of the printer, so users must be sure to log out.

Note

- Consult the User Administrator about your log in user name, password, and user code.
- For user code authentication, enter a number registered in the Address Book as User Code.

User Code Authentication (Using the Printer Driver)

To specify User Code using the printer driver, you must specify a user code in the printer Printing Preference of the printer driver.

1. On the [Start] menu, click [Printers and Faxes].

The [Printers and Faxes] window appears.

2. Click the icon of the printer you want to use.

3. On the [File] menu, click [Printing Preferences...].

The [Printing Preferences] dialog box appears.

4. Click the [Detailed Settings] tab.

5. In the [Menu:] box, click the [Job Setup] icon.

6. Enter the user code in [User Code:], using up to 8 numeric characters.

7. Click [OK].

Log in (Using the Control Panel)

Use the following procedure to log in when Basic Authentication, Windows Authentication, LDAP Authentication, or Integration Server Authentication is enabled.

1. Press the [Menu] key.

2. Press [Login].

3. Enter the login user name using the number keys, and then press the [OK] key.

4. Enter the login password using the number keys, and then press the [OK] key.

When the user is authenticated, the screen for the function you are using appears.

Log out (Using the Control Panel)

Use the following procedure to log out when Basic Authentication, Windows Authentication, or LDAP Authentication is set.

1. Press the [Menu] key.
2. Press [Logout].
3. Press [Yes].

↓ Note

- Users who log in using the printer driver do not have to log out.

Log in (Using the Printer Driver)

When Basic Authentication, Windows Authentication, or LDAP Authentication is set, users must enter a login user name and password to use the machine and/or print an individual job.

Setting Authentication

1. On the [Start] menu, click [Printers and Faxes].
The [Printers and Faxes] window appears.
2. Click the icon of the printer you want to specify authentication for.
3. On the [File] menu, click [Properties].
The [Printer Properties] dialog box appears.
4. Click the [Advanced Options] tab.
5. On the [Authentication] menu, select [User Authentication].
6. Click [OK].

Setting Authentication for individual print jobs

1. On the [Start] menu, click [Printers and Faxes].
The [Printers and Faxes] window appears.
2. Click icon of the printer you want to specify authentication for.
3. Click [Printing Preferences...].
The [Printing Preferences] dialog box appears.
4. Click the [Detailed Settings] tab.
5. In the [Menu:] box, click the [Job Setup] icon.
6. Click [Authentication...].
The [Authentication] dialog box appears.

7. In [Login User Name:], enter a login user name using up to 32 characters.
8. In [Login Password:], enter a login password using up to 128 characters. Then, in [Reenter the confirmation password:], enter the login password again, and then click [OK].

Log in (Using Web Image Monitor)

Use the following procedure to log in to the printer via Web Image Monitor.

1. Click [Login] in the Header area of Web Image Monitor.
2. Enter a login user name and password, and then click [Login].

Depending on the configuration of your Web browser, the login user name and password might be saved. If you do not want to save them, configure your Web browser's settings so that this information is not saved.

↓ Note

- For user code authentication, enter a user code in "User Name", and then click [Login].
- The procedure may differ depending on Web Image Monitor used.

Log out (Using Web Image Monitor)

Use the following procedure to log out of Web Image Monitor.

1. Click [Logout] to log out.

↓ Note

- Delete the cache memory in Web Image Monitor after logging out.

2. Printing Documents

This chapter explains how to print documents using the printer driver. It also describes the procedure for configuring PDF Direct Print and other printing functions.

Displaying the Printer Driver Settings Screen

2

This section explains how to open and configure the printer driver properties.

The following procedure explains how to configure the printer driver settings under Windows XP. If you are using another operating system, the procedure might vary slightly.

Making Printer Default Settings - The Printer Properties

★ Important

- To change the printer's default settings (including settings for options), log on using an account that has Manage Printers permission. Members of the Administrators group have Manage Printers permission by default.
- You cannot change the printer default settings for individual users. Settings made in the [Printer Properties] dialog box are applied to all users.

1. On the [Start] menu, click [Printers and Faxes].

The [Printers and Faxes] window appears.

2. Click the icon of the printer you want to use.

3. On the [File] menu, click [Properties].

The [Printer Properties] dialog box appears.

4. Make the settings you require, and then click [OK].

↓ Note

- Depending on the applications, the settings you make here may not be used as the default settings.
- For details, see the printer driver Help.

Making Printer Default Settings - Printing Preferences

★ Important

- When the printer driver is distributed from the print server, the setting values specified by the server are displayed as the default for [Printing Defaults...].

1. On the [Start] menu, click [Printers and Faxes].

The [Printers and Faxes] window appears.

2. Click the icon of the printer you want to use.**3. On the [File] menu, click [Printing Preferences...].**

The [Printing Preferences] dialog box appears.

4. Make the settings you require, and then click [OK].

The setting is temporarily registered as [Unregistered] in the [One Click Preset List:] area.

Note

- Depending on the applications, the settings you make here may not be used as the default settings.
- The [Unregistered] setting is invalid if the other [One Click Presets] icon is selected. If you wish to confirm the [Unregistered] setting, click [Register Current Settings...]. For details about confirming the setting, see "Making Printer Settings - One Click Presets".
- For details, see the printer driver Help.

Reference

- p.29 "Making Printer Settings - One Click Presets"

Making Printer Settings from an Application

You can make printer settings for a specific application.

To make printer settings for a specific application, open the [Printing Preferences] dialog box from that application. The following procedure explains how to make printer settings for a specific application using Windows XP WordPad as an example.

1. On the [File] menu, click [Print...].

The [Print] dialog box appears.

2. In the [Select Printer] list, select the printer you want to use.**3. Click [Preferences].**

The [Printing Preferences] dialog box appears.

4. Make the settings you require, and then click [OK].**Note**

- Procedures for opening the [Printing Preferences] dialog box vary depending on the application. For details, see the manuals provided with the application.
- Any settings you make using this procedure apply to the current application only.
- General users can change the properties displayed in the [Print] dialog box of an application. Settings made here are used the defaults when printing from the application.

- For details, see the printer driver Help.

Making Printer Settings - One Click Presets

This section explains how to register and use one click presets.

Each function explained in this section is preconfigured and registered under [One Click Preset List:] on the [One Click Presets] tab.

You can apply the relevant setting simply by clicking on the one click preset name. This helps to avoid incorrect settings and misprints.

One click presets can be added, modified, and deleted as required. By using registered one click presets, users without in-depth knowledge of the printer driver can utilize advanced printing functions easily.

Follow the procedure to register one click presets.

- 1. In the application, on the [File] menu, click [Print].**

The [Print] dialog box appears.

- 2. Select the printer, and then open the [Printing Preferences] dialog box in the document's native application.**

The [Printing Preferences] dialog box appears.

- 3. Make the settings you require.**

- 4. Click [Register Current Settings...]. Enter a name and comment that describe the setting, and then click [OK].**

The newly registered icon appears with its registered name in the [One Click Preset List:] area.

- 5. Click [OK].**

Note

- Under Windows operating systems, this function is available through the PCL 6 and PostScript 3 printer driver.
- For details about modifying and deleting one click presets, see the printer driver Help.

Frequently Used Print Methods

This section explains how to use the various printing functions including normal printing, duplex printing, and combine printing.

Each function described in this section is configured and registered under "One Click Presets". You can also change the parameters for each function by modifying "One Click Presets". For details about custom settings, see "Making Printer Settings - One Click Presets".

Reference

- p.29 "Making Printer Settings - One Click Presets"

Standard Printing

Use the following procedure to print documents using the normal printing function with the printer driver.

Important

- If you are using a Type 2 model with ELP NX installed, all print jobs for which "Normal Print" or "Locked Print" is specified are stored in ELP NX when user authentication is set. After issuing the print command from the printer driver, log in to ELP NX and print the job.
- If you are using a Type 2 model with ELP NX installed, all print jobs for which "Locked Print" is specified are stored in ELP NX when user authentication is not set. Also note that any jobs for which "Locked Print" is not specified will be deleted according to the default setting of ELP NX.
- For details about how to print using ELP NX, see Enhanced Locked Print NX User's Guide.
- For details about the option settings of ELP NX, consult your administrator.
- Before printing, make sure that the settings for the installed options and loaded paper are correctly configured.

For the PCL 6 printer driver:

1. After creating a document, open the Printing Preferences dialog box in the document's native application.
The [Printing Preferences] dialog box appears.
2. Click the [One Click Presets] tab, if it is not already selected.
3. In the [Job Type:] list, select [Normal Print].
If you want to print multiple copies, specify a number of sets in the [Copies:] box.
4. In the [Document Size:] list, select the size of the original to be printed.
5. In the [Orientation:] list, select [Portrait] or [Landscape] as the orientation of the original.

6. In the [Input Tray] list, select the paper tray that contains the paper you want to print onto.

If you select [Auto Tray Select] in the [Input Tray] list, the source tray is automatically selected according to the paper size and type specified.

7. In the [Paper Type:] list, select the type of paper that is loaded in the paper tray.
8. Select [Color] or [Black and White] in the [Color/ Black and White:] list.
9. To save current setting in the One Click Preset List, click [Register Current Settings...]. Enter a name and comment that describe the setting, and then click [OK].

The newly registered icon appears in the [One Click Preset List:] area.

10. Click [OK] to close the Printing Preferences dialog box.
11. Print the document using the print function in the document's native application.

For the PCL 5c printer driver:

1. After creating a document, open the Printing Preferences dialog box in the document's native application.

The [Printing Preferences] dialog box appears.

2. In the [Job Type:] list, select [Normal Print].

If you want to print multiple copies, specify a number of sets in the [Copies:] box.

3. In the [Orientation:] list, select [Portrait] or [Landscape] as the orientation of the original.

4. Select [Color] or [Black and White] in the [Color/ Black and White:] list.

5. Click the [Paper] tab.

6. In the [Document Size:] list, select the size of the original to be printed.

7. In the [Input Tray:] list, select the paper tray that contains the paper you want to print onto.

If you select [Auto Tray Select] in the [Input Tray:] list, the source tray is automatically selected according to the paper size and type specified.

8. In the [Type:] list, select the type of paper that is loaded in the paper tray.

9. Click [OK] to close the Printing Preferences dialog box.

10. Print the document using the print function in the document's native application.

↓ Note

- The types of paper loaded in the paper trays are indicated on the printer's display. This allows you to see which tray the selected paper type is loaded in. However, the paper type setting available in the printing preference dialog box might be different from the type indicated on the printer's display.
- If a warning message appears notifying you of a paper type or size mismatch see "If Errors Occur with the Specified Paper Size and Type".

- If [Color] is selected in the [Color/ Black and White:] list, you can print using special color outputs suitable for color vision impaired users. To use this function, click the [Detailed Settings] tab. Click the [Print Quality] menu in the [Menu:] box, and then select [Barrier-free Color Management]. This function is available with the PCL 6 and PostScript 3 printer driver.

E Reference

- p.61 "If Errors Occur with the Specified Paper Size and Type"

2

Printing on Both Sides of Sheets

This section explains how to print on both sides of each page using the printer driver.

For the PCL 6 printer driver:

1. **After creating a document, open the Printing Preferences dialog box in the document's native application.**

The [Printing Preferences] dialog box appears.

2. **To use an existing One Click Presets, click the [One Click Presets] tab, and then click the icon in the [One Click Preset List:] box.**

If you do not wish to modify a custom setting that is already registered in the printer driver, change settings such as paper size and source tray as required, and then proceed to step 8.

3. **Click the [Detailed Settings] tab.**
4. **In the [Menu:] box, click the [Edit] icon.**
5. **In the [2 sided:] list, select [Open to Left], or [Open to Top].**
6. **Change any other print settings if necessary.**
7. **To save current setting in the One Click Preset List, click [Register Current Settings...]. Enter a name and comment that describe the setting, and then click [OK].**

The newly registered icon appears in the [One Click Preset List:] area.

8. **Click [OK] to close the Printing Preferences dialog box.**
9. **Print the document using the print function in the document's native application.**

For the PCL 5c printer driver:

1. **After creating a document, open the Printing Preferences dialog box in the document's native application.**

The [Printing Preferences] dialog box appears.

2. **In the [Duplex:] list, [Open to Left], [Open to Top], or [Booklet:].**
3. **Change any other print settings if necessary.**
4. **Click [OK] to close the Printing Preferences dialog box.**
5. **Print the document using the print function in the document's native application.**

Note

- If the document contains pages with different original sizes, page breaks may occur.

Paper sizes and types supported by duplex printing function

This section explains the paper sizes and types that can be used with the duplex printing function.

2

Paper sizes supported by duplex printing function

- A4
- A5
- A6
- B5
- B6
- $8\frac{1}{2} \times 14$
- $8\frac{1}{2} \times 13$
- $8\frac{1}{2} \times 11$
- $8\frac{1}{4} \times 13$
- 8×13
- $7\frac{1}{4} \times 10\frac{1}{2}$
- $5\frac{1}{2} \times 8\frac{1}{2}$
- 16K
- Custom

Note

- Tray 1 - 4 supports custom size paper approximately 98 - 216 mm (3.86 - 8.5 inches) in width and 148 - 355.5 mm (5.83 - 13.99 inches) in length. When loading custom size paper in tray 1 - 4, be sure to specify the custom size using both the control panel and the printer driver.
- Bypass Tray supports custom size paper approximately 70 - 216 mm (2.76 - 8.5 inches) in width and 127 - 1260 mm (5 - 49.6 inches) in length. When loading custom size paper in tray 1 - 4, be sure to specify the custom size using both the control panel and the printer driver.

Paper types supported by duplex printing function

- Plain Paper
- Middle Thick
- Thick 1
- Thick 2
- Letterhead
- Coated Paper (Glossy)

- Coated Paper (Matted)
- Special Paper 1
- Special Paper 2
- Special Paper 3
- Recycled Paper

2

Types of duplex printing

This section explains the binding directions available when using the duplex printing function. When using the duplex printing function, you can select whether to bind copies by edge or in the center.

Edge Binding

- Open to Left

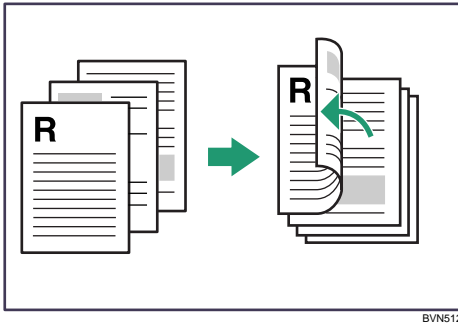

- Open to Top

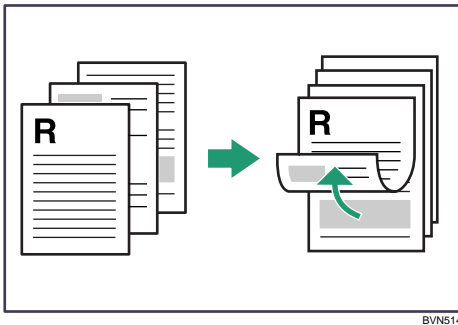

- Booklet:

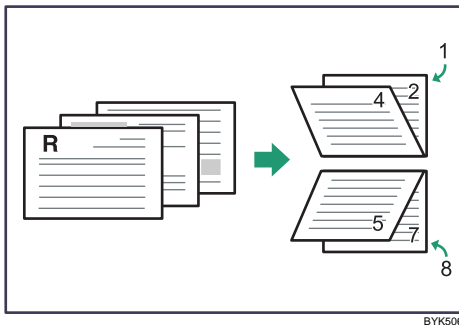
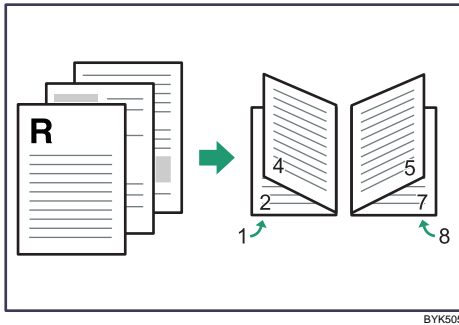

Combining Multiple Pages into Single Page

This section explains how to print multiple pages onto a single sheet. The combine printing function allows you to economize on paper by printing multiple sheets at reduced size onto a single sheet.

★ Important

- The combine printing function is not available on a custom size paper. To use the combine printing function, specify a standard size paper.

For the PCL 6 printer driver:

1. After creating a document, open the Printing Preferences dialog box in the document's native application.

The [Printing Preferences] dialog box appears.

2. To use an existing One Click Presets, click the [One Click Presets] tab, and then click the icon in the [One Click Preset List:] box.

If you do not wish to modify a custom setting that is already registered in the printer driver, change settings such as paper size and source tray as required, and then proceed to step 8.

3. Click the [Detailed Settings] tab.
4. In the [Menu:] box, click the [Edit] icon.
5. In the [Layout:] list, select the combination pattern.

6. Change any other print settings if necessary.
7. To save current setting in the One Click Preset List, click [Register Current Settings...]. Enter a name and comment that describe the setting, and then click [OK].
The newly registered icon appears in the [One Click Preset List:] area.
8. Click [OK] to close the Printing Preferences dialog box.
9. Print the document using the print function in the document's native application.

For the PCL 5c printer driver:

1. After creating a document, open the Printing Preferences dialog box in the document's native application.
The [Printing Preferences] dialog box appears.
2. In the [Layout:] list, select the combination pattern.
3. Change any other print settings if necessary.
4. Click [OK] to close the Printing Preferences dialog box.
5. Print the document using the print function in the document's native application.

↓ Note

- If the document contains pages with different original sizes, page breaks may occur.
- If the application you are using also has a combine function, disable it. If the application's combine function is also enabled when the driver's combine function enabled, incorrect printing is likely.
- For details about combining pages with different orientations and other advanced functions, see the printer driver Help.

Types of combine printing

This section explains the different methods of combine printing that are available. For 2 pages per sheet combine, you can select from three patterns. When combining 4 or more pages onto a single sheet of paper, four patterns are available. The page order can be specified from the following four patterns:

2 Pages per Sheet

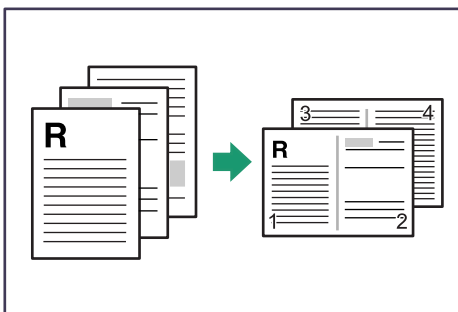

BVN521

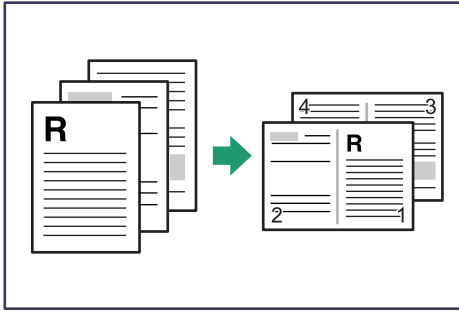

BVN526

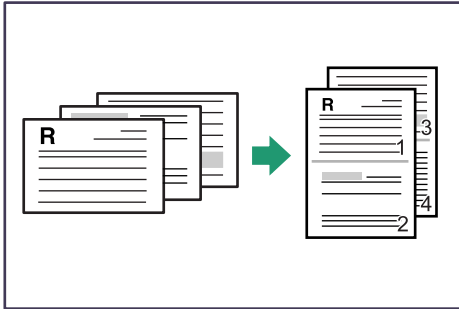

BVN527

4 Pages per Sheet

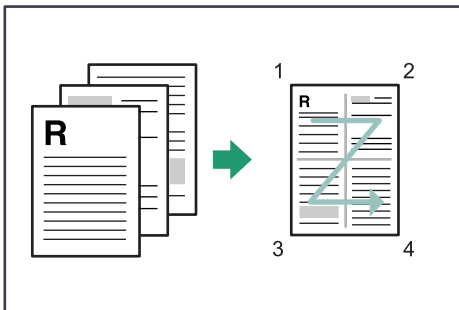

BVN522

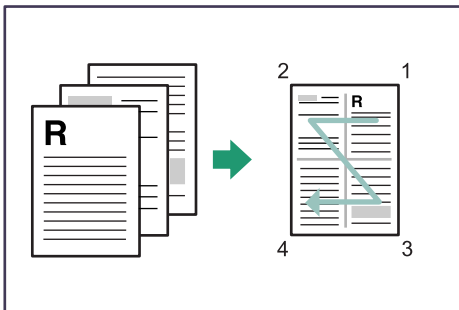

BVN523

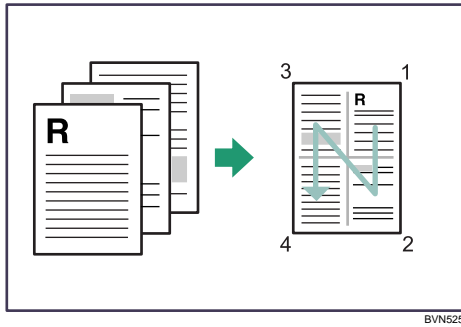
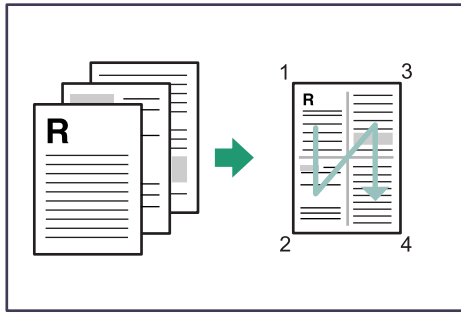

Advanced Printing

This section explains the printer's advanced printing functions.

Other than the functions that can be configured in the [One Click Presets] tab, various print functions can be setup from each [Menu:] icon in the [Detailed Settings] tab. The settings for each function described in this section can be changed by using the following menus.

Using the PCL6 printer driver as an example, the following procedure explains how to configure the printer's advanced printing functions.

2

Menu Names and Brief Overview of Each Function

The following is an overview of the settings that are available on the [Basic], [Paper], and [Effects] menus.

[Basic] menu

You can specify the type of the paper you want to print on.

- Document Size:

If the printer's trays do not contain paper matching the settings of the print job, you can proceed with printing by using the bypass tray.

For details about this function, see "Specifying Printer Driver or Print Command Priority".

[Paper] menu

You can enable/disable the cover and slip sheets function.

- Paper Type

You can specify the type of the paper you want to print on. If the printer's trays do not contain paper matching the settings of the print job, you can proceed with printing by using the bypass tray.

For details about this function, see "Specifying Printer Driver or Print Command Priority".

- Front Cover

Using this function, you can insert cover sheets fed from a different tray to that of the main paper, and print on them. For details, see "Printing on Cover Sheet".

- Slip Sheet

Using this function, you can insert slip sheets fed from a different tray to that of the main paper, and print on them. For details, see "Inserting Slip Sheets".

[Effects] menu

You can enable/disable the Watermark function.

The Watermark function prints text under the main content of every page of a document. For details about this function, see "Printing with Watermarks".

Reference

- p.40 "Specifying Printer Driver or Print Command Priority"
- p.42 "Printing on Cover Sheet"
- p.43 "Inserting Slip Sheets"
- p.45 "Printing with Watermarks"

2

Specifying Printer Driver or Print Command Priority

If you select [Any Size/Type] or [Any Custom Size/Type] for [Bypass Tray] in [Tray Setting Priority] under [Print Settings] using the control panel, you can print onto a specified paper without changing or confirming the paper settings for print jobs.

If the printer's trays do not contain paper matching the settings of the print job, you can proceed with printing by applying the paper settings specified in the print job to paper fed from the bypass tray. You do not need to change the paper settings using the control panel, even if you frequently use paper of different sizes, or if you are printing onto an unusual type of paper.

★ Important

- To continue printing from the bypass tray onto all paper sizes, select [Any Size/Type] for [Bypass Tray] in [Tray Setting Priority] under [Print Settings]. To continue printing from the bypass tray onto custom size paper only, select [Any Custom Size/Type] for [Bypass Tray] in [Tray Setting Priority] under [Print Settings]. For details about each setting on the Print Settings menu, see "Print Settings Menu".
- Select [Auto Tray Select] in the printer driver. If [Auto Tray Select] is specified when a job is sent to the printer, the matching tray will be detected in the order specified in [Tray Priority] under [Paper Input]. If you select [Bypass Tray] for [Tray Priority], paper will always be fed from the bypass tray, as long as paper is loaded there. For details about printer driver settings, see "Menu Names and Brief Overview of Each Function". For details about the [Tray Priority] setting, see "Paper Input Menu Parameters".

If you select [Any Size/Type] or [Any Custom Size/Type] for the bypass tray, jobs will be printed in the following manner.

Any Size/Type

If the printer's trays do not contain paper matching the settings of the print job, printing can proceed from the bypass tray with the job's settings applied.

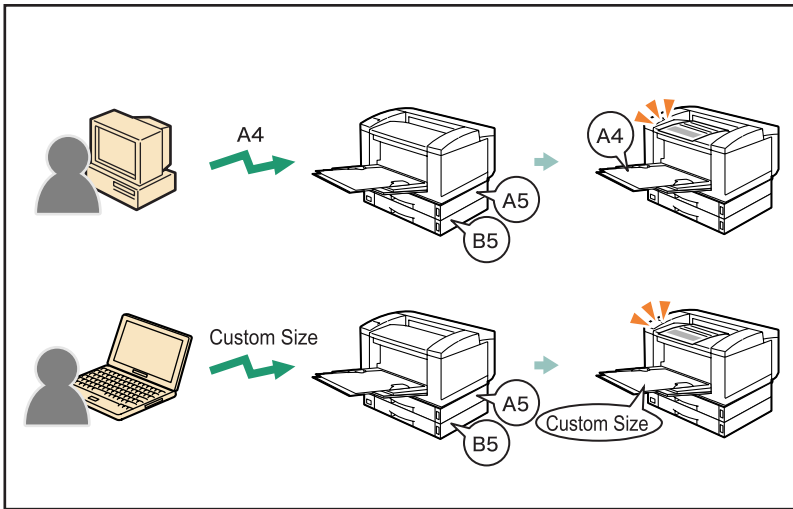

BVP507

Any Custom Size/Type

If the printer's trays do not contain paper matching the settings of the print job but custom paper was specified using the printer driver or by print command, printing can proceed from the bypass tray with the job's settings applied.

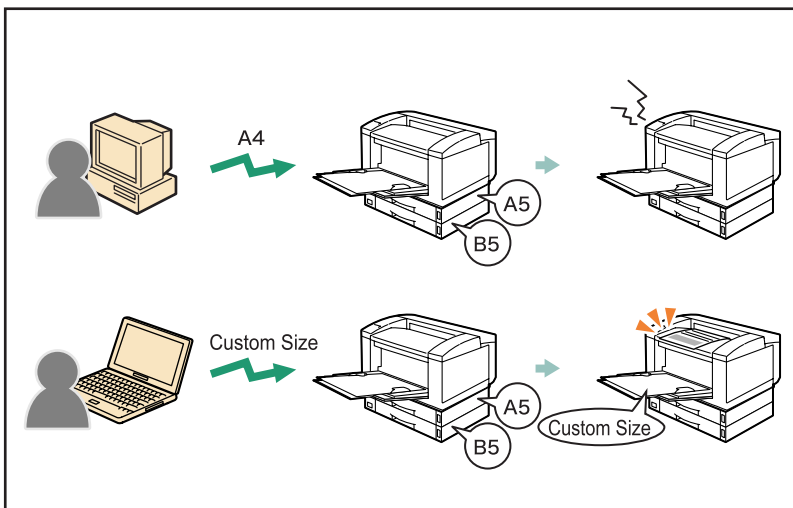

BVP508

↓ Note

- When this function is enabled, printing may be slower than usual.
- If paper is not loaded in the bypass tray when a job is received, a message prompting you to load paper will appear on the control panel. When this message appears, load paper of the indicated size and type print side up on the bypass tray.

- If a job features pages of different paper sizes that are not loaded in the trays, the entire job will be printed on paper fed from the bypass tray. If the printer's trays contain paper matching the required sizes, the relevant pages will be printed on paper fed from those trays.

Reference

- p.40 "Specifying Printer Driver or Print Command Priority"
- p.105 "Paper Input Menu"
- p.130 "Print Settings Menu"

Printing on Cover Sheet

Using this function, you can insert cover sheets fed from a different tray to that of the main paper, and print on them.

Important

- **To use this function, Collate must be set.**

Prints the first page of the document on the sheet for the cover page.

Print on one side

Prints on one side of the cover sheet only, even when duplex printing is selected.

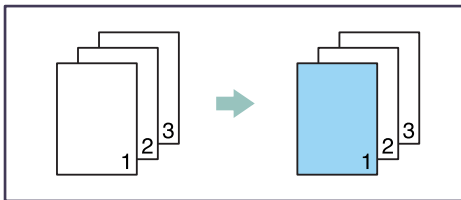

Print on both sides

Prints on both sides of the cover sheet when duplex printing is selected.

- Cover sheet printed on both sides

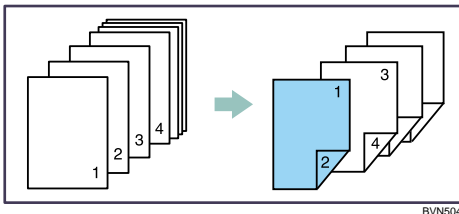

- Cover sheet printed on one side

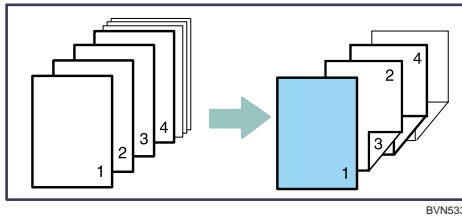

Blank

- When printing one side

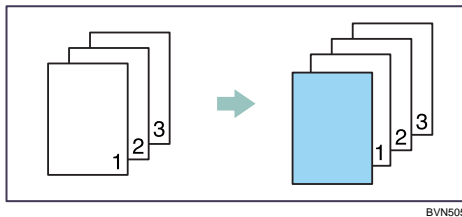

- When printing both side

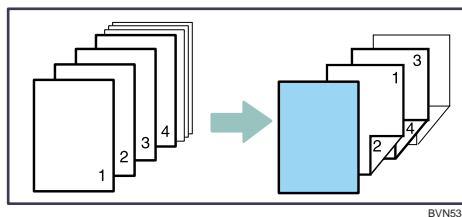

Note

- The cover sheets should be the same size and orientation as the body of the paper.
- If "Auto Tray Select" is set for the body paper feed tray, body paper will be delivered from a tray that contains paper set in portrait orientation. Therefore, if the cover paper is set to landscape orientation, the orientation of the cover and body paper will be different.
- For printing methods, see the printer driver Help.

Inserting Slip Sheets

Inserting a slip sheet between each page

- Print

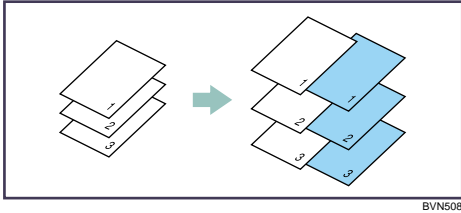

BVN508

- Blank

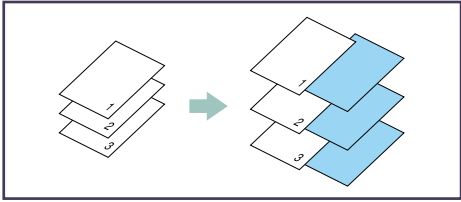

BVN506

Inserting a slip sheet between OHP transparencies

- Print

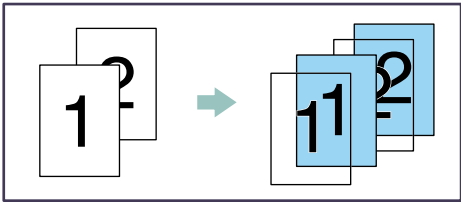

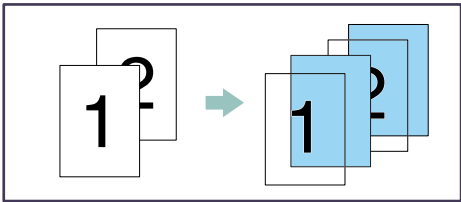

BVN509

- Blank



BVN507

↓ Note

- Collate cannot be set when using slip sheets.
- When the duplex printing or cover printing is set, you cannot insert slip sheets.
- The slip sheet should be the same size and orientation as the body paper.
- If "Auto Tray Select" has been set as the paper feed tray for the body paper, the paper will be delivered from a tray containing paper in  orientation. Therefore, when the slip sheet has been set to  orientation, the orientation of the output slip sheet and body paper will be different.
- The same paper feed tray cannot be set for the body of the document and slip sheets.

Printing with Watermarks

Using this function, you can print documents with text watermarks.

This function increases a document's security and identifiability by embedding a specified text (watermark) on every page. You can specify only one type of watermark at a time.

↓ Note

- You can create and apply custom watermarks. For details about creating original watermarks, see the printer driver Help.

2

Types of watermarks

This section explains the types of watermarks available.

Following are the pre-registered text watermarks that are available:

- COPY

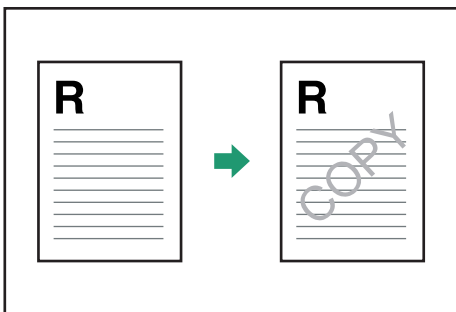

BMU900S

- URGENT

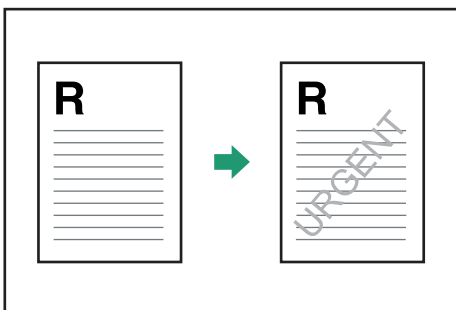

BMU901S

- CONFIDENTIAL

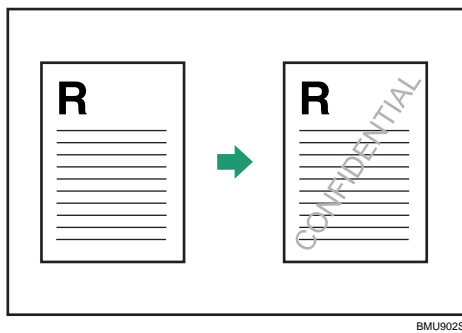

BMU902S

- DRAFT

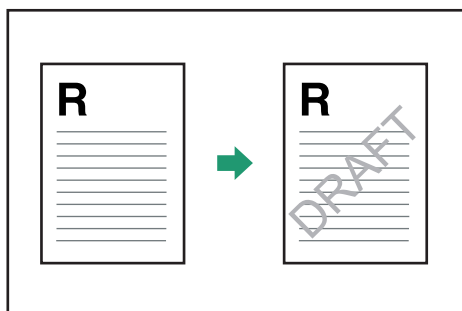

BMU903S

- ORIGINAL

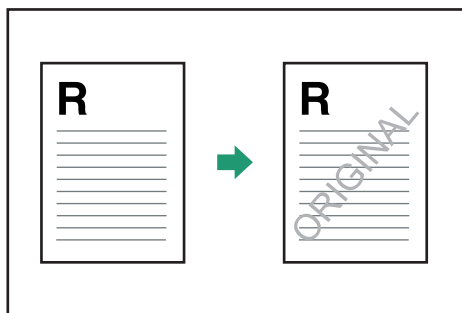

BMU904S

Collate Function

This section explains the printer's Collate function.

The Collate function allows you to print while sorting printouts into page-ordered sets, such as when printing multiple copies of meeting materials.

★ Important

- Up to 150 pages can be stored in the printer's RAM. If the hard disk is installed, up to 1,000 pages can be stored.

Output can be assembled as sets in sequential order.

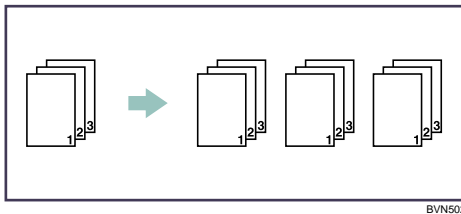

↓ Note

- Collate will be canceled if "Auto Continue" is specified during printing of the first set.
- Collate will be canceled if a form feed error occurs during printing of the first set.

Spool Printing

Spool Printing allows print jobs transferred from a computer to be temporarily stored, and then prints them after they are transferred. This shortens printing time as it maximizes printer efficiency.

With Spool Printing, the print data is saved in the hard disk before printing. To use this function, set it from the menu. See UNIX Supplement.

2

★ Important

- This function is available only if the hard disk is installed on the printer.
- Use the "spoolsw clear job" telnet command to clear a spooled print job. Do not turn off the printer or computer while a print job is being spooled and the Data In is flashing. Print jobs that are interrupted in this way remain on the printer's hard disk and will finish printing out when the printer is turned back on.
- The Spool Printing function is available for data received using "diprint", "lpr", "ipp", "ftp", "sftp (TCP/IP (IPv6))", and "wsd (printer)".
- When using diprint, the Spool Printing function cannot be used with bi-directional communication.
- The domain reserved for spool printing is about 1 GB.
- When Spool Printing is on, the size of a single print job cannot exceed 500 MB.
- When receiving jobs from multiple computers, the printer can spool a maximum of ten lpr jobs, and only one "diprint", "ipp", "ftp", "sftp", "smb", or "wsd (printer)" job. If the printer's spooling capacity is exceeded, newer jobs cannot be printed. You must wait before sending further jobs.

↓ Note

- Printing the first page with Spool Printing will be slow.
- The computer requires less print processing time when large amounts of data are spooled.
- Stored spool jobs can be viewed or deleted using Web Image Monitor.
- The list of spool jobs cannot be viewed from the printer's control panel.
- For information about the "spoolsw clear job" command on the telnet, see UNIX Supplement.

Setting Spool Printing

Spool printing settings can be made using control panel or telnet or Web Image Monitor.

- Using control panel
In [System] menu, select [On] in [Spool Printing].
- Using Web Image Monitor
In [System] on the [Configuration] menu, click [Active] in [Spool Printing].
- Using telnet

Enter "spoolsw spool on".

↓ Note

- For details about control panel, see "System Menu".
- For details about Web Image Monitor, see Web Image Monitor Help.
- For details about "spoolsw spool on", see UNIX Supplement.

📖 Reference

- p.124 "System Menu"

Viewing or Deleting spooled jobs using Web Image Monitor

Follow the procedure below to check or delete spooled jobs using Web Image Monitor.

- 1. Open a Web browser.**
- 2. Enter "http://(printer's IP address)/" in the address bar to access the printer whose settings you want to change.**

Top Page of Web Image Monitor appears.
- 3. Click [Login].**

The window for entering the login user name and password appears.
- 4. Enter the login user name and password, and then click [Login].**

Contact your administrator for information about the settings.
- 5. In the menu area, click [Job].**

A submenu will appear.
- 6. On the [Printer] menu, click [Spool Printing].**

A list of spooled jobs appears.
- 7. To delete a job, select the check box of the job you want to delete, and then click [Delete].**

The selected job is deleted.
- 8. Click [Logout].**
- 9. Quit Web Image Monitor.**

↓ Note

- For details about Web Image Monitor, see Web Image Monitor Help.

Printing a PDF File Directly

This section explains how to print PDF files directly without having to open a PDF application by using DeskTopBinder Lite or UNIX commands.

2

Using DeskTopBinder Lite

This section explains how to print PDF files directly without having to open a PDF application by using DeskTopBinder Lite. To use this function, you must first download DeskTopBinder Lite from the manufacturer's Website and install it on your computer. Contact your local dealer for information on downloading DeskTopBinder Lite.

★ Important

- This function is possible for genuine Adobe PDF files only.
- Version 1.3, 1.4, 1.5, and 1.6 PDF files are compatible.
- PDF files created using PDF version 1.5 Crypt Filter functions or more than eight DeviceN Color Space components cannot be printed.
- PDF files created using PDF version 1.6 watermark note functions, or extended optional contents cannot be printed.
- PDF version 1.7 (Acrobat 8.0) files created without any functions that are exclusive to PDF version 1.7 can be printed.
- If the document contains transparency function data, it may fail to print. When this happens, use the printer driver to print the document.
- Due to reasons such as insufficient memory, some types of high compression PDF files created using the machine's scanner function cannot be printed directly.

↓ Note

- Paper size errors may occur when printing on custom size paper.

Expanding DeskTopBinder Lite features

This section explains how to extending the features of DeskTopBinder Lite.

To extend a feature, click on its icon in the [Type:] list.

The following procedure explains how to use the extended features Wizard to print PDF files directly.

1. On the [Start] menu, point to [All Programs], [DeskTopBinder], and then click [Extended Features Wizard].

The [Extended Features Wizard] dialog box appears.

2. Select [Easy settings], then click [Start] and then, click [Next>] repeatedly until the [Printing Function2] dialog box appears.

If you have selected [All function settings], click [Start], and then click the [Output] icon in the [Type:] list. Select [PDF Direct Print] in [Selectable function(s):], and then click [Add].

3. In the [Printing Function2] dialog box, click [Add...].

The [PDF Direct Print Properties] dialog box appears.

4. Select the printer's name, and then click [OK].

The [PDF Direct Print Properties] dialog box closes.

5. Click [Specify...], and then enter the IP address or host name of the printer.

6. Click [Next>] repeatedly until [Finish] appears.

7. Click [Finish].

Function palette

The Function Palette contains buttons for functions that are already configured through expanded DeskTopBinder Lite functions. Using these buttons, you can print Windows files, preview printouts, convert images, and register scanners for documents without having to open DeskTopBinder Lite. You can also use these functions simply by dragging a target file to the button corresponding to the required function and dropping it there.

1. On the [Start] menu, point to [All Programs], [DeskTopBinder], and then click [Function Palette].

An icon for the Function palette is added to the task tray displayed at the bottom right of the screen.

2. Right-click the new icon that has been added to the task tray, and then click [Properties...].

The [Properties] dialog box appears.

3. Click the [Contents] tab, select the [PDF Direct Print] check box at the center, and then click [OK].

The [Properties] screen closes and the [PDF Direct Print] icon is added to the palette.

PDF Direct Printing Using Function Palette

Follow the procedure below to print PDF files directly.

1. Drag the PDF file you want to print to the PDF Direct Printing icon on the Function Palette and drop it there.

The [Output File List - PDF Direct Print] dialog box appears.

2. Highlight the PDF file you want to print, and then click [OK].

The PDF file is printed.

PDF Direct Print Properties

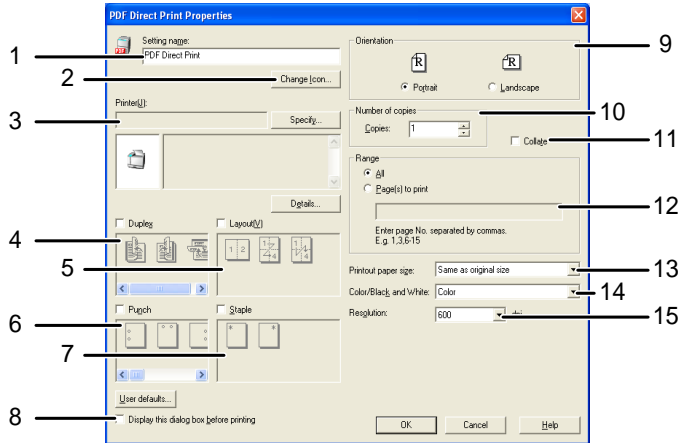

BRP007S

1. Setting name:

Displays the plug-in configuration name (up to 63 single byte characters)

2. Change Icon...

Changes the icon displayed on the tool bar.

3. Printer:

Displays printer's IP address or hostname.

4. Duplex

Prints on both sides of sheets.

5. Layout

Prints multiple pages on a single sheet.

6. Punch (not supported for this printer)

Punches holes in printed sheets.

7. Staple (not supported for this printer)

Staples together printed sheets.

8. Display this dialog box before printing

Appears in PDF direct printing mode if this check box is selected.

9. Orientation:

Specify the original's orientation.

10. Number of copies

Specify the number of copies to print.

11. Collate

Sorts printed sheets.

12. Range:

Specify which paper to print.

13. Printout paper size:

Specify the paper size you want copies to be printed onto.

14. Color/Black and White:

Specify color or black-and-white printing.

15. Resolution:

Specify a print resolution.

Using Commands to Print

This section explains how to print PDF files directly using printing commands, such as "ftp", "sftp", and "lpr".

Sending a PDF file

Use the following procedure to send a PDF file to this printer using printing commands.

Following is an example when using the "lpr" command to print a PDF file by specifying the printer's IP address.

```
c:> lpr -S printer's IP address -P printer name [-o l] \path\ PDF file name
```

Note

- Entering the text enclosed in brackets [] is optional.

Entering the PDF password

Use the following procedure to print a password protected PDF file directly.

To print a PDF file that is protected by a password, enter the password using the control panel, Web Image Monitor, or the PJI command. When the password is entered using the PJI command, the password entered using the control panel or Web Image Monitor is ignored.

Using the PJI command

To enter the password for a password protected PDF file, use the following command and value in conjunction with the PJI command.

- Command: SET
- Value: PDFPASSWORD
- Example: @PJI SET PDFPASSWORD=the PDF password

Up to 32 ASCII characters (0x20 - 0x7E (Except 0x22)) can be entered as the PDF password.

Using the Control Panel

To enter a PDF password using the control panel, select [Change PDF Password] on [PDF Menu] under [Print Settings].

Using Web Image Monitor

To enter the PDF password using Web Image Monitor, select [Set Password], and then set [PDF Temporary Password].

Specifying the Classification Code for a Print Job

When printing in an environment where classification codes are required, a classification code must be specified for each print job.

★ Important

- The PostScript 3 printer driver does not support the classification codes and it cannot be used to print under environment which the classification codes are required.

2

For the PCL 6 printer driver:

1. Open the printer properties dialog box after creating a document in an application.
2. Click the [Detailed Settings] tab.
3. In the [Menu:] box, click the [Job Setup] icon.
4. Enter the classification code in the [Classification Code:] box, and then click [OK].

This code identifies the user. The classification code can contain up to 32 alphanumeric (a-z, A-Z, 0-9, "-") characters.

5. Make any other necessary print settings, and then click [OK].
6. A confirmation message appears. Read it, and then click [OK].
7. Execute the print command.
8. The print job is sent to the printer.

For the PCL 5c printer driver:

1. Open the printer properties dialog box after creating a document in an application.
2. Click the [Valid Access] tab.
3. Enter the classification code in the [Classification Code:] box.

This code identifies the user. The classification code can contain up to 32 alphanumeric (a-z, A-Z, 0-9, "-") characters.

4. Make any other necessary print settings, and then click [OK].
5. A confirmation message appears. Read it, and then click [OK].
6. Execute the print command.
7. The print job is sent to the printer.

↓ Note

- The specified classification code is stored in the printer driver.
- To switch between different classification codes, install the printer driver under different names, and specify different classification code for each driver.

- For details about how to view the log collected using Classification Code, see the manual for the external log collection system.

Using the Virtual Printer

This section explains virtual printer functions.

A virtual printer is a pseudo printer that can only be recognized on a network. The virtual printer has various print options, such as feeding tray selection and duplex printing, which you can set in advance. You can also use the interrupt printing function. This function suspends the ongoing job and gives priority to a new job.

This function is available only if the hard disk is installed on the printer.

If you use the virtual printer under UNIX, Solaris, and other operating systems, various print functions are possible without having you manually enter usual print commands.

Adding a Virtual Printer

Use this procedure to add a virtual printer.

★ Important

- Adding a virtual printer requires Administrators privilege. Log in using an account that has Administrators privilege.
- The following Virtual Printer protocols are available: "TCP/IP (Unspecified, Normal)", "TCP/IP (Unspecified, Priority)", "TCP/IP (DIPRINT)", "TCP/IP (RHPP)", "AppleTalk", and "NetWare".

1. Log in to Web Image Monitor as an administrator.
2. In the menu area, click [Configuration], and then click [Virtual Printer Settings] in the "Printer" category.

A list of the available virtual printers appears.

3. Click [Add].

The screen for adding virtual printers appears.

4. In [Virtual Printer Name], enter a name for the new printer, and then select the protocol in the [Protocol] list.

5. Click [OK].

The virtual printer is added.

↓ Note

- If you select [TCP/IP (DIPRINT)], [AppleTalk], or [NetWare] in the [Protocol] list, you cannot specify a virtual printer name.
- You can specify a virtual printer name using up to 47 characters.
- You can add up to 50 virtual printers. After 50 virtual printers have been added, [Add] will no longer be displayed.

- For details about login user names and passwords, see "Using Web Image Monitor".

Reference

- p.155 "Using Web Image Monitor"

2

Changing a Virtual Printer Configuration

Use this procedure to change a virtual printer configuration.

Important

- **You must have Administrators privilege to change the configuration of a virtual printer. Log in using an account that has Administrators privilege.**

1. Log in to Web Image Monitor as an administrator.

2. In the menu area, click [Configuration], and then click [Virtual Printer Settings] in the "Printer" category.

A list of the available virtual printers appears.

3. Select the virtual printer whose configuration you want to change, and then click [Change].

If you want to configure this virtual printer for an interrupt printer, select [TCP/IP (Unspecified, Priority)] in the protocol list.

4. Change the configuration as required.

5. Click [OK].

Note

- For details about virtual printer configuration, see Web Image Monitor Help.
- For details about login user names and passwords, see "Using Web Image Monitor".

Reference

- p.155 "Using Web Image Monitor"

Confirming a Virtual Printer Configuration

Use this procedure to confirm a virtual printer configuration.

1. Start Web Image Monitor.

2. In the menu area, click [Configuration], and then click [Virtual Printer Settings] in the "Printer" category.

A list of available virtual printers appears.

3. Select the virtual printer whose configuration details you want to confirm, and then click [Details].

A configuration list for the selected virtual printer appears.

↓ Note

- [Details] is not displayed if you log in to Web Image Monitor as an administrator. To confirm a virtual printer configuration, click [Change].
- For details about login user names and passwords, see "Using Web Image Monitor".

📖 Reference

- p.155 "Using Web Image Monitor"

Deleting a Virtual Printer

Use this procedure to delete a virtual printer.

★ Important

- You must have Administrators privilege to delete a virtual printer. Log in using an account that has Administrators privilege.

1. Log in to Web Image Monitor as an administrator.
2. In the menu area, click [Configuration], and then click [Virtual Printer Settings] in the "Printer" category.

The list of available virtual printers appears.

3. Select the virtual printer that you want to delete, and then click [Delete].

The delete confirmation screen appears.

4. Click [OK].

↓ Note

- You cannot delete this printer's default virtual printer.
- [Delete] appears only if you have already added a virtual printer.
- For details about login user names and passwords, see "Using Web Image Monitor".

📖 Reference

- p.155 "Using Web Image Monitor"

Printing Using a Virtual Printer

To print directly from a specified virtual printer, assign the virtual printer in the print command. If you use the interrupt printing function, enter the name of the virtual printer that you configured for interrupt printing. Before printing for the first time, specify the virtual printer you want to use.

2

1. Log in to Web Image Monitor in administrator mode.
2. In the menu area, click [Configuration], and then click [Basic Settings] in the "Printer" category.
3. Select [Active] in [Virtual Printer], and then click [OK].
4. Send a command from your computer.

lpr

```
c:> lpr -S printer's IP address -P Virtual printer name [-o l] \path\file name
```

rcp

```
c:> rcp [-b] \path name\file name [\path\file name...] printer's host name:["Virtual Printer Name"]
```

ftp

```
ftp>mput \path\file name [\path\ Virtual Printer Name]
```

Note

- When the ongoing job meets any of the following conditions, interrupt printing is not possible even if you print with the virtual printer that is configured for interrupt printing. The printer waits to print a new job until it finishes printing the current job.
 - When the ongoing print job is performed using the bypass tray
 - When a function related to cover or slip paper is specified for the ongoing print job
- If a large amount of memory is used for the ongoing print job or a large number of sheets are being printed, there may not be enough memory to process an interrupt print job, or only part of the interrupt job may be printed. If this happens, certain functions for the interrupt job, such as stapling or storing data onto the printer, can be canceled or sheets can be sorted in a number smaller than the standard maximum capacity.
- For details about login user names and passwords, see "Using Web Image Monitor".

Reference

- p.155 "Using Web Image Monitor"

If Errors Occur with the Specified Paper Size and Type

If no trays contain paper matching the specified size and type, or if the paper fed from the bypass tray does not match the size and type specified for the print job, a message warning you of the mismatch will appear on the control panel. Resolve the mismatch by following the message's instructions.

2

Changing the Paper Tray Settings

Use the following procedure to change the paper size and type specified for a tray and continue printing.

1. On the warning screen, press [Change].

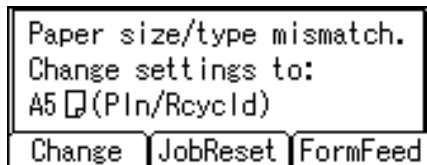

The [Paper Input] screen appears.

2. Press the [▼] or [▲] key to select the tray whose paper size setting you want to change, and then press the [OK] key.
3. Press the [▼] or [▲] key to select the paper size you require, and then press the [OK] key.

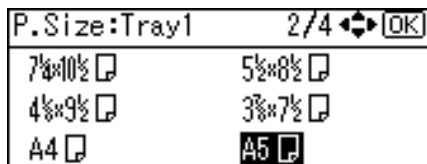

The [Paper Input] screen appears.

4. Press the [▼] or [▲] key to select the tray whose paper type you want to change, and then press the [OK] key.
5. Press the [▼] or [▲] key to select the paper type you require, and then press the [OK] key.

The [Paper Input] screen appears.

6. Press the [Escape] key

Printing starts if the selected tray contains paper matching the size and type settings specified in the print job.

Printing from a Selected Tray

If the printer does not have a tray for the selected paper size or paper type, or if the selected paper loaded in the printer has run out, a caution message appears. If this message appears, do the following procedure.

1. When the caution message appears, press [FormFeed].

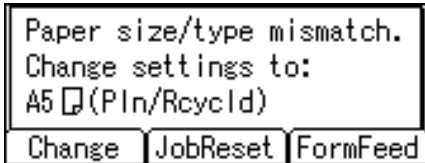

A confirmation message appears.

2. Press the [OK] key.
3. Select the tray for form feed using the [▼] or [▲] key from those that appear on the display panel, and then press the [OK] key.

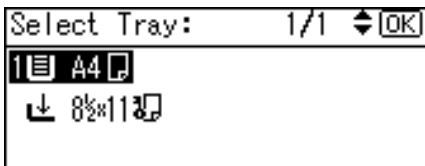

Note

- If a tray with a smaller paper size is selected, the print job may be cut short, or other problems may occur.

Canceling a Print Job

Follow this procedure for canceling the print job if the message prompting form feed appears.

1. Press [JobReset].

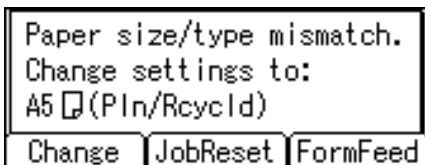

2. Press [Current].

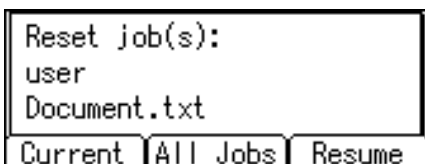

The confirmation message appears.

To resume printing jobs, press [Resume].

3. Press [Yes] to cancel the print job.

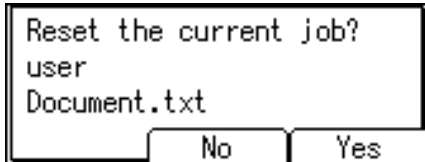

4. Press [No] to return to the previous display.

Note

- If the printer is shared by multiple computers, be careful not to accidentally cancel someone else's print job.
- Under Windows, If the printer is connected to the computer using a parallel cable, sent print jobs may be canceled if the [Job Reset] key is pressed while "Please wait..." is displayed on the control panel. After the interval set in [I/O Timeout] in [Host Interface] has passed, the next print job can be sent. A print job sent from a different client computer will not be canceled in this case.
- You cannot stop printing data that has already been processed. For this reason, printing may continue for a few pages after you press the [Job Reset] key.
- A print job containing a large volume of data may take considerable time to stop.
- To stop data printing, see "Canceling a Print Job".

Reference

- p.85 "Canceling a Print Job"

Proceeding with Printing using the Bypass Tray

If you select [Any Size/Type] or [Any Custom Size/Type] for the bypass tray, a warning message will appear whenever the paper fed from the source tray does not match the size or type specified in the print job.

When this warning message appears, check the size of the loaded paper and do the following.

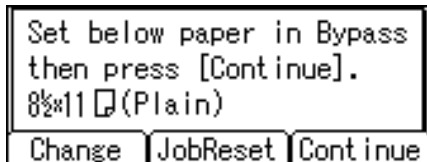

- 1. Load paper of the size/type indicated in the message onto the bypass tray.**
- 2. Press [Continue].**

Printing resumes from the page in which the error occurred.

Note

- For details about [Any Size/Type] or [Any Custom Size/Type], see "Specifying Printer Driver or Print Command Priority" and "Print Settings Menu".

Reference

- p.40 "Specifying Printer Driver or Print Command Priority"
- p.130 "Print Settings Menu"

3. Printing Stored Documents

This chapter explains how to print documents stored in the printer.

Using the Print Job Function

This describes how to print or delete files stored in the printer. There are following types of print files: Sample Print, Locked Print, Hold Print, and Stored Print.

Print files sent from computers can be stored in the hard disk of the printer. Using the Print Job function, you can print or delete the print files.

3

★ Important

- This function is available only if the hard disk is installed on the printer.

Print Job Screen



If you press [Prt.Jobs] on the initial screen, a screen prompting to select the type of print job appears.

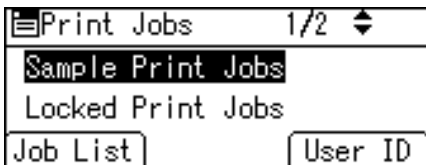

After selecting a type, you can select print files in the list by pressing:

- [Job List]
Displays the Job List screen.
- [User ID]
Displays the User ID screen.

If you select Sample Print, Locked Print, or Hold Print, the print files saved in the printer are deleted after printing is completed. If you select Stored Print, the files remain in the printer even after printing is finished.

Job List Screen

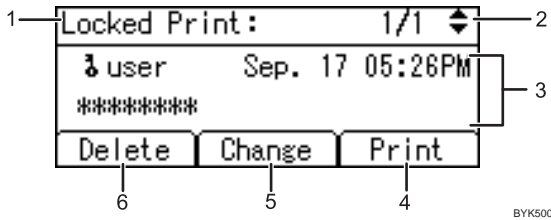

1. The type of print jobs

Displays the type of the print job you select.

2. Page number

Displays the current page number. Each time pressing the [▼] or [▲] key, the screen switches.

3. User ID, Date/Time, and File Name display

- User ID shows the user's ID set by the printer driver.
- Date and Time show the time at which the print job was stored in the printer.
- File name shows the name of the file. However, "*****" is shown instead of the file name for a Locked Print file.

4. [Print]

Prints a selected file.

5. [Change]

Changes or clears the password of a file if a password is set. To change the password of a Locked/Stored Print job, press [Change], enter the current password, and then enter the new password on the confirmation screen. To clear the password, press [Change], leave the entering/confirming a new password box blank, and then press the [OK] key.

You can also set passwords to the Stored Print files that do not currently have passwords.

6. [Delete]

Deletes a selected file.

↓ Note

- When you press [Change] to change or clear a password, you must first enter the existing password. If the password you entered is incorrect, you cannot change or clear any current passwords.
- You can use [Change] to set or clear passwords only when Stored Print files are stored in the printer.

User ID Screen

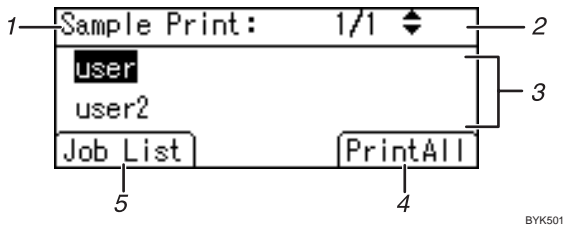

1. The type of print jobs

Displays the type of the print job you select.

2. Page number

Displays the current page number. Each time pressing the [▼] or [▲] key, the screen switches.

3. User ID

- User ID shows the ID of the user who stored the selected type of files.
- User ID set by the printer driver is shown.

4. [PrintAll]

Prints all files stored by the user whose user ID has been selected.

5. [Job List]

Switches the screen to the [Job List] screen.

Displays the print jobs of the selected user only.

↓ Note

- To cancel selecting a file, press the [Job Reset] key.
- The display is not updated if a new file is stored while the list of stored files is displayed. To update the display, press the [Menu] key to return to the initial screen, and then press [Prt.Jobs] again.
- If a large number of print jobs are stored in the printer, processing may slow temporarily, depending on which functions are used.

📖 Reference

- For details about printing each type of print job, see the followings:
 - p.68 "Sample Print"
 - p.71 "Locked Print"
 - p.75 "Hold Print"
 - p.78 "Stored Print"

Printing from the Print Job Screen

This section gives instruction about Sample Print, Locked Print, Hold Print, and Stored Print.

★ Important

- If you are using a Type 2 model with ELP NX installed, all print jobs for which "Normal Print" or "Locked Print" is specified are stored in ELP NX when user authentication is set. After issuing the print command from the printer driver, log in to ELP NX and print the job.
- If you are using a Type 2 model with ELP NX installed, all print jobs for which "Locked Print" is specified are stored in ELP NX when user authentication is not set. Also note that any jobs for which "Locked Print" is not specified will be deleted according to the default setting of ELP NX.
- For details about how to print using ELP NX, see Enhanced Locked Print NX User's Guide.
- For details about the option settings of ELP NX, consult your administrator.
- This function is available only if the hard disk is installed on the printer.

Sample Print

Use this function to print only the first set of a multiple-set print job. After you have checked the result, remaining sets can be printed or canceled using the printer's control panel. This can reduce misprints due to mistakes in content or settings.

★ Important

- A Sample Print file cannot be stored if:
 - the hard disk is not installed in the printer.
 - the total number of Sample Print, Locked Print, Hold Print, and Stored Print files in the printer is over 100. (The maximum number varies depending on the volume of data in files.)
 - the file contains over 1,000 pages.
 - sent or stored files in the printer contain over 9,000 pages in total.

↓ Note

- If a Sample Print file has not been stored properly, check the error log in the control panel.
- Even after you turn off the printer, stored documents in the printer remain. However, the [Auto Delete Temporary Jobs] or [Auto Delete Stored Jobs] settings are applied first.
- If the application has a collate option, make sure it is not selected before sending a print job. By default, Sample Print jobs are automatically collated by the printer driver. If a collate option is selected from the application's Print dialog box, more prints than intended may be produced.
- If the first set of the Sample Print files is not as you expected and you do not want to print remaining sets, delete the Sample Print file using the display panel. If you print the remaining sets of the Sample Print file, the job in the printer is deleted automatically.

- Sample Print files printed or deleted using Web Image Monitor, after you select [Sample Print] using the control panel will appear on the display panel. However, an error message will appear if you try to print or delete those Sample Print files.
- If stored files have similar and long file names, recognizing the file you want to print on the display panel may be difficult. Print the file you want to print either by checking the user ID or the time the file is sent, or by changing the file name to something that can be recognized easily.
- For details about the error log in the display panel, see "Checking the Error Log".
- For details about [Auto Delete Temporary Jobs] and [Auto Delete Stored Jobs], see "Maintenance Menu".

Reference

- p.110 "Maintenance Menu"
- p.153 "Checking the Error Log"

Printing a Sample Print file

The following procedure describes how to print a Sample Print file with the PCL 6/PCL5c or PostScript 3 printer driver.

Important

- **Applications with their own drivers, such as PageMaker, do not support this function.**

1. From an application, select a command to print.

The Print dialog box appears.

2. Select the printer you want to use in the [Name] list, and then click [Properties].

The printer properties dialog box appears.

3. In the [Job Type:] list, click [Sample Print].

4. Click [Details...], and then enter a user ID in the [User ID:] box.

This is used to identify the user. The user ID can contain up to eight alphanumeric characters (a-z, A-Z, 0-9).

5. Execute a command to print.

Make sure to set more than two copies.

The Sample Print job is sent to the printer, and the first set is printed.

6. On the printer's control panel, press [Prt.Jobs].



7. Select [Sample Print Jobs] using the [▼] or [▲] key, and then press [Job List].



A list of Sample Print files stored in the printer appears.

Depending on the security settings, certain print jobs may not be displayed.

You can print files also by pressing [User ID].

8. Select the file you want to print using the [▼] or [▲] key, and then press [Print].

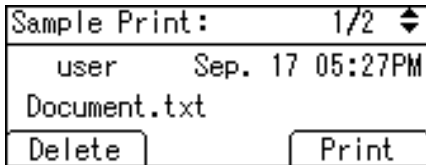

Enter the new number of sets using the scroll keys. You can enter up to 999 sets.

Press the [Escape] key to correct any entry mistakes.

9. Press [Print].

The remaining sets are printed.

To cancel printing, press [Cancel].

↓ Note

- If the set quantity is changed when [User ID] is pressed in step 7, the changed quantity is applied to all selected files.
- When printing is completed, the stored file will be deleted.
- To stop printing after printing has started, press the [Job Reset] key. The file will be deleted.
- For details about [User ID], see "Printing from the User ID Screen".

📖 Reference

- p.82 "Printing from the User ID Screen"

Deleting Sample Print files

If you are not satisfied with the Sample printout, you can delete the Sample Print file, revise it and print it again until the settings are suitable.

1. Press [Prt.Jobs].



2. Select [Sample Print Jobs] using the [▼] or [▲] key, and then press [Job List].

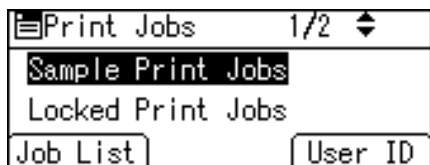

A list of Sample Print files stored in the printer appears.

Depending on the security settings, certain print jobs may not be displayed.

3. Select the file you want to delete using the [▼] or [▲] key, and then press [Delete].

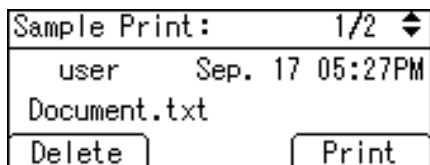

The delete confirmation screen will appear.

4. Press [Delete].

The selected file is deleted.

To cancel printing, press [Cancel].

Locked Print

Use this function to maintain privacy when printing confidential documents on the printer over a shared network. Usually, it is possible to print data using the display panel once it is stored in this printer. When using Locked Print, it is not possible to print unless a password is entered on the printer's display panel. Your confidential documents will be safe from being viewed by other people.

★ Important

- If you are using a Type 2 model with ELP NX installed, all print jobs for which "Normal Print" or "Locked Print" is specified are stored in ELP NX when user authentication is set. After issuing the print command from the printer driver, log in to ELP NX and print the job.
- If you are using a Type 2 model with ELP NX installed, all print jobs for which "Locked Print" is specified are stored in ELP NX when user authentication is not set. Also note that any jobs for which "Locked Print" is not specified will be deleted according to the default setting of ELP NX.

- For details about how to print using ELP NX, see *Enhanced Locked Print NX User's Guide*.
- For details about the option settings of ELP NX, consult your administrator.
- A Locked Print file cannot be stored if:
 - the hard disk is not installed in the printer.
 - the total number of Sample Print, Locked Print, Hold Print, and Stored Print files in the printer is over 100. (The maximum number varies depending on the volume of data in files.)
 - the file contains over 1,000 pages.
 - sent or stored files in the printer contain over 9,000 pages in total.

 **Note**

- If a Locked Print file has not been stored properly, check the error log in the control panel.
- Even after you turn off the printer, stored documents remain. However, the [Auto Delete Temporary Jobs] or [Auto Delete Stored Jobs] settings are applied first.
- If the application has a collate option, make sure it is not selected before sending a print job. Locked Print jobs are automatically collated by the printer driver as default. If a collate option is selected in the application print dialog box, more sets than intended may be printed.
- After the Locked Print file is printed, the job is automatically deleted.
- Locked Print files printed or deleted using Web Image Monitor, after you select [Locked Print] using the control panel will appear on the display panel. However, an error message will appear if you try to print or delete those Locked Print files.
- For details about the error log in the display panel, see "Checking the Error Log".
- For details about [Auto Delete Temporary Jobs] and [Auto Delete Stored Jobs], see "Maintenance Menu".

 **Reference**

- p.110 "Maintenance Menu"
- p.153 "Checking the Error Log"

Printing a Locked Print file

The following procedure describes how to print a Locked Print file with the PCL 6/PCL 5c or PostScript 3 printer driver.

 **Important**

- Applications with their own drivers, such as PageMaker, do not support this function.

1. Configure the Locked Print in the printer driver's properties.

For details about configuring the printer drivers, see the corresponding Help files.

2. Start printing from the application's Print dialog box.

The Locked Print job is sent to the printer.

3. On the printer's control panel, press [Prt.Jobs].



4. Select [Locked Print Jobs] using the [▼] or [▲] key, and then press [Job List].

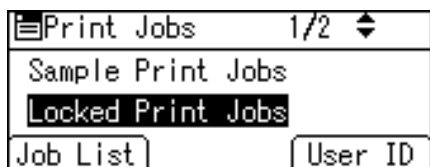

A list of Locked Print files stored in the printer appears.

Depending on the security settings, certain print jobs may not be displayed.

You can print files also by pressing [User ID].

5. Select the file you want to print using the [▼] or [▲] key, and then press [Print].

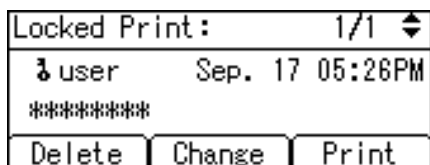

The password screen appears.

6. Enter the password using the number keys, and then press the [OK] key.

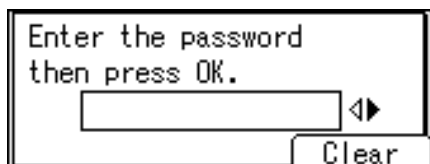

The print confirmation screen appears.

A confirmation screen will appear if the password is not entered correctly. Press [Clear] to enter the password again.

If you forget your password, contact your administrator for help.

7. Press [Print].

The remaining sets are printed.

To cancel printing, press [Cancel].

Note

- When printing is completed, the stored file will be deleted.
- To stop printing after printing has started, press the [Job Reset] key. The file will be deleted.
- For details about [User ID], see "Printing from the User ID Screen".

Reference

- p.82 "Printing from the User ID Screen"

3 Deleting Locked Print files

1. Press [Prt.Jobs].



2. Select [Locked Print Jobs] using the [▼] or [▲] key, and then press [Job List].



A list of Locked Print files stored in the printer appears.

Depending on the security settings, certain print jobs may not be displayed.

3. Select the file you want to delete using the [▼] or [▲] key, and then press [Delete].

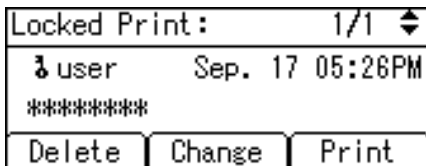

The password screen appears.

4. Enter the password using the number keys, and then press the [OK] key.

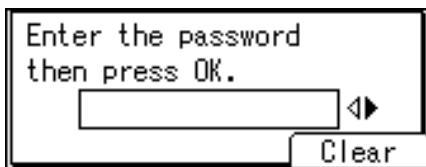

The delete confirmation screen appears.

A confirmation screen will appear if the password is not entered correctly. Press [Clear] to enter the password again.

If you forget your password, contact your administrator for help.

5. Press [Delete].

The selected file is deleted.

To cancel printing, press [Cancel].

Hold Print

3

Use this function to temporarily hold a file in the printer, and print it from the computer or the printer's control panel later.

★ Important

- **A Hold Print file cannot be stored if:**
 - the hard disk is not installed in the printer.
 - the total number of Sample Print, Locked Print, Hold Print, and Stored Print files in the printer is over 100. (The maximum number varies depending on the volume of data in files.)
 - the file contains over 1,000 pages.
 - sent or stored files in the printer contain over 9,000 pages in total.

↓ Note

- If a Hold Print file has not been stored properly, check the error log in the control panel.
- Even after you turn off the printer, stored documents in the printer remain. However, the [Auto Delete Temporary Jobs] or [Auto Delete Stored Jobs] settings are applied first.
- If the application has a collate option, make sure it is not selected before sending a print job. By default, Hold Print jobs are automatically collated by the printer driver. If a collate option is selected from the application's Print dialog box, more prints than intended may be produced.
- Hold Print files printed or deleted using Web Image Monitor, after you select [Hold Print] using the control panel will appear on the display panel. However, an error message will appear if you try to print or delete those Hold Print files.
- If stored files have similar and long file names, recognizing the file you want to print on the display panel may be difficult. Print the file you want to print either by checking the user ID or the time the file is sent, or by changing the file name to something that can be recognized easily. If you enter the document name on the printer driver's [Details...], that name appears on the display panel.
- It is possible, but not required, to set a file name or a password to a Hold Print file.
- For details about the error log in the display panel, see "Checking the Error Log".
- For details about [Auto Delete Temporary Jobs] and [Auto Delete Stored Jobs], see "Maintenance Menu".

Reference

- p.110 "Maintenance Menu"
- p.153 "Checking the Error Log"

Printing a Hold Print file

The following procedure describes how to print a Hold Print file with the PCL 6/PCL 5c or PostScript 3 printer driver.

3

Important

- Applications with their own drivers, such as PageMaker, do not support this function.

1. Configure Hold Print in the printer driver's properties.

For details about configuring the printer drivers, see the relevant Help files.

2. Click [Details...], and then enter a user ID in the [User ID:] box.

You can also set a file name. The file name you set will be displayed on the printer's Job List screen.

3. Start printing from the application's Print dialog box.

The Hold Print job is sent to the printer and stored.

4. On the printer's control panel, press [Prt.Jobs].



5. Select [Hold Print Jobs] using the [▼] or [▲] key, and then press [Job List].

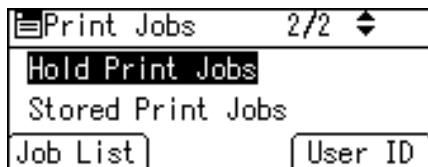

A list of Hold Print files stored in the printer appears.

Depending on the security settings, certain print jobs may not be displayed.

You can print files also by pressing [User ID].

6. Select the file you want to print using the [▼] or [▲] key, and then press [Print].

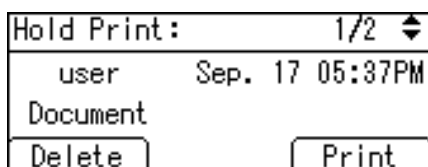

The confirmation screen appears.

7. Press [Print].

The Hold Print file is printed.

To cancel printing, press [Cancel].

↓ Note

- When printing is completed, the stored file will be deleted.
- To stop printing after printing has started, press the [Job Reset] key. The file will be deleted.
- For details about setting printer drivers, see the printer driver Help. You can also print or delete a Hold Print file from Web Image Monitor. For details, see Web Image Monitor Help.
- For details about [User ID], see "Printing from the User ID Screen".

📖 Reference

- p.82 "Printing from the User ID Screen"

3

Deleting Hold Print files

1. Press [Prt.Jobs].



2. Select [Hold Print Jobs] using the [▼] or [▲] key, and then press [Job List].

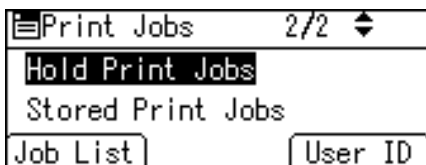

A list of Hold Print files stored in the printer appears.

Depending on the security settings, certain print jobs may not be displayed.

3. Select the file you want to delete using the [▼] or [▲] key, and then press [Delete].

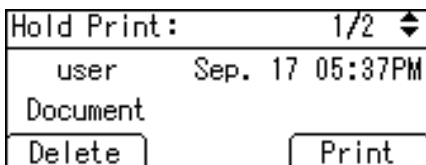

The confirmation screen appears.

4. Press [Delete].

The selected file is deleted.

To cancel printing, press [Cancel].

Stored Print

Use this function to store a file in the printer, and then print it from the computer or the printer's control panel later.

Jobs are not deleted after they are printed, so the same job need not be resent in order to print multiple copies.

★ Important

- **A Stored Print file cannot be stored if:**
 - the hard disk is not installed in the printer.
 - the total number of Sample Print, Locked Print, Hold Print, and Stored Print files in the printer is over 100. (The maximum number varies depending on the volume of data in files.)
 - the file contains over 1,000 pages.
 - sent or stored files in the printer contain over 9,000 pages in total.

↓ Note

- If a Stored Print file has not been stored properly, check the error log in the control panel.
- Even after you turn off the printer, stored documents in the printer remain. However, the [Auto Delete Temporary Jobs] or [Auto Delete Stored Jobs] settings are applied first.
- If the application has a collate option, make sure it is not selected before sending a print job. By default, Stored Print jobs are automatically collated by the printer driver. If a collate option is selected from the application's Print dialog box, more prints than intended may be produced.
- Stored Print files printed or deleted using Web Image Monitor, after you select [Stored Print] using the control panel will appear on the display panel. However, an error message will appear if you try to print or delete those Stored Print files.
- If stored files have similar and long file names, recognizing the file you want to print on the display panel may be difficult. Print the file you want to print either by checking the user ID or the time the file is sent, or by changing the file name to something that can be recognized easily.
- If you enter the document name on the printer driver's [Details...], that name appears on the display panel.
- For details about the error log in the display panel, see "Checking the Error Log".
- For details about [Auto Delete Temporary Jobs] and [Auto Delete Stored Jobs], see "Maintenance Menu".

Reference

- p.110 "Maintenance Menu"
- p.153 "Checking the Error Log"

Printing a Stored Print file

The following procedure describes how to print a Stored Print file with the PCL 6/ PCL 5c or PostScript 3 printer driver.

Important

- Applications with their own drivers, such as PageMaker, do not support this function.

1. Configure the Stored Print in the printer driver's properties.

You can select two ways for Stored Print:

- [Stored Print]
Stores the file in the printer and print it later using the control panel.
- [Store and Normal Print] (or [Store and Print])
Prints the file at once and also stores the file in the printer.

For details about configuring the printer drivers, see the relevant Help files.

2. Click [Details...], and then enter a user ID in the [User ID:] box.

You can also set a password. The same password must be entered when printing or deleting.

You can also set a file name. The file name you set will be displayed on the printer's Job List screen.

3. Start printing from the application's Print dialog box.

The Stored Print job is sent to the printer.

4. On the printer's control panel, press [Prt.Jobs].



5. Select [Stored Print Jobs] using the [▼] or [▲] key, and then press [Job List].

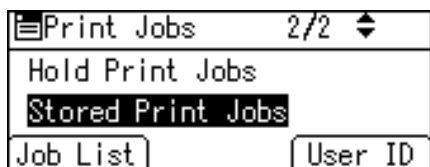

A list of Stored Print files stored in the printer appears.

You can print files also by pressing [User ID].

6. Select the file you want to print using the [▼] or [▲] key, and then press [Print].

Stored Print:		1/1	↕
user	Sep. 17 05:39PM		
Document			
Delete	Change	Print	

The confirmation screen appears.

If you set a password in the printer driver, a password confirmation screen appears. Enter the password.

If you want to print multiple copies, specify a number of sets in the [Copies:] box.

7. Press [Print].

The Stored Print file is printed.

To cancel printing, press [Cancel].

↓ **Note**

- When multiple files are selected without setting a quantity, one set less than the minimum number of all settings is applied. If the least number of settings is one set, all selected files will be printed at one set.
- If the number of set quantity is changed when [User ID] is pressed in step 5, the changed quantity is applied to all selected files.
- To stop printing after printing has started, press the [Job Reset] key. A Stored Print file is not deleted even if the [Job Reset] key is pressed.
- The Stored Print file that sent to the printer is not deleted unless you delete a file or select [Auto Delete Stored Jobs].
- You can set or delete a password after sending files to the printer. Select the file and press [Change] in the Print Job List screen. To set a password, enter the new password. To delete the password, leave the password box blank on entering or confirming the new password, and press the [OK] key.
- For details about the [Auto Delete Stored Jobs], see "Maintenance Menu".
- For details about [User ID], see "Printing from the User ID Screen".

📖 **Reference**

- p.82 "Printing from the User ID Screen"
- p.110 "Maintenance Menu"

Deleting stored print files

1. Press [Prt.Jobs].



2. Select [Stored Print Jobs] using the [▼] or [▲] key, and then press [Job List].

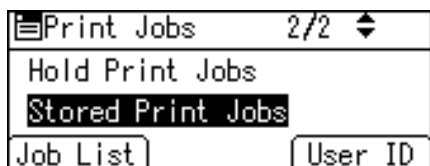

A list of Stored Print files stored in the printer appears.

Depending on the security settings, certain print jobs may not be displayed.

3. Select the file you want to delete using the [▼] or [▲] key, and then press [Delete].

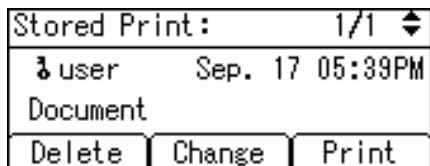

The delete confirmation screen will appear.

If you set the password in the printer driver, enter the password to delete.

If you forget your password, contact your administrator for help.

4. Press [Delete].

The selected file is deleted.

To cancel printing, press [Cancel].

Printing from the User ID Screen

This describes how to print the files saved in the printer from the User ID screen.

Printing the Selected Print Job

1. On the initial screen, press [Prt.Jobs].



2. Press [User ID].

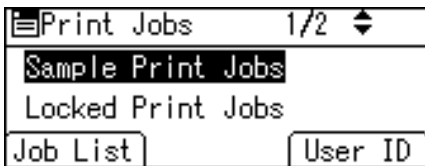

A list of user IDs whose files are stored in the printer appears.

3. Select the user ID whose file you want to print using the [▼] or [▲] key, and then press [Job List].

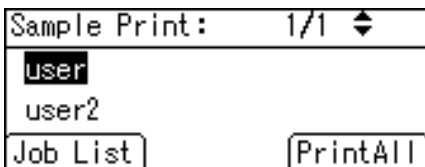

The print job list of the selected user ID appears.

4. Select the file you want to print using the [▼] or [▲] key, and then press [Print].

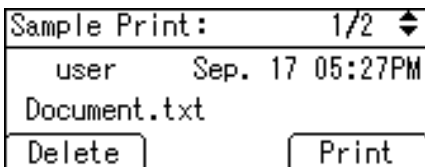

The confirmation screen appears.

5. Press [Print].

The selected file is printed.

To cancel printing, press [Cancel].

Note

- If you print a Sample, Locked, or Hold Print file, the print file saved in the printer is deleted after printing is completed.

Reference

- For details about printing each type of print job, see the followings:
- p.68 "Sample Print"
- p.71 "Locked Print"
- p.75 "Hold Print"
- p.78 "Stored Print"

Printing All Print Jobs

1. On the initial screen, press [Prt.Jobs].



2. Select a type of print jobs you want to print using the [▼] or [▲] key, and then press [User ID].

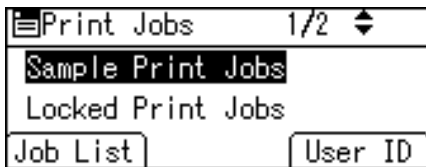

A list of user IDs whose files are stored in the printer appears.

3. Select the user ID whose file you want to print using the [▼] or [▲] key, and then press [PrintAll].

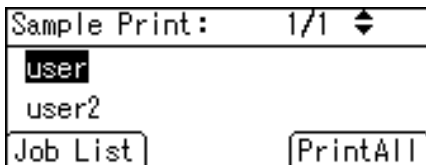

The confirmation screen appears.

4. Press [Print].

The selected files are printed.

To cancel printing, press [Cancel].

Note

- If you print a Sample, Locked, or Hold Print file, the print file saved in the printer is deleted after printing is completed.
- You cannot select a print job that is not stored under the selected user ID.
- When printing multiple Sample Print files without specifying the number of sets on the confirmation screen, one set less than the least number of set specified on the computer is applied for every selected document. If the number of sets specified on the computer is "1", one set each is printed for every document.
- When printing multiple Stored Print files without specifying the number of sets on the confirmation screen, the least number of set specified on the computer is applied for every selected document.
- If you select [Locked Print Jobs], enter the correct password. If there are multiple passwords, the printer prints only files that correspond to the entered password.
- If you select Stored Print files, and some of these require a password, the printer prints files that correspond to the entered password and files that do not require a password.

Reference

- For details about printing each type of print job, see the followings:
- p.68 "Sample Print"
- p.71 "Locked Print"
- p.75 "Hold Print"
- p.78 "Stored Print"

Canceling a Print Job

You can cancel printing from either the printer or a client computer. Since canceling procedures vary depending on the print job status, check the job status and cancel printing according to the following procedure.

Canceling a Print Job Using the Control Panel

1. Press [JobReset].

A confirmation message appears.

2. Press [Current].

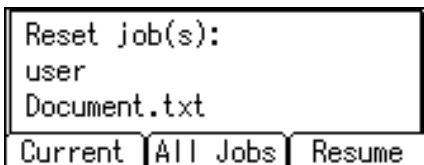

To resume printing jobs, press [Resume].

3. Press [Yes] to cancel the print job.

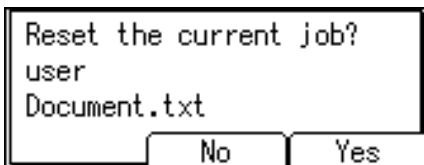

Press [No] to return to the previous display.

Windows - Canceling a Print Job from the computer

You can cancel a print job from the computer if transferring print jobs is not completed.

1. Double-click the printer icon on the Windows task tray.

A window appears, showing all print jobs currently queued for printing. Check the current status of the job you want to cancel.

2. Select the name of the job you want to cancel.
3. On the [Document] menu, click [Cancel].

Note

- If the printer is shared by multiple computers, be careful not to accidentally cancel someone else's print job.

- If the printer is connected to the computer using a parallel cable, sent print jobs may be canceled if [JobReset] is pressed while "Please wait..." is displayed on the control panel. After the interval set in [I/O Timeout] in Printer Features has passed, the next print job can be sent. A print job sent from a different client computer will not be canceled in this case.
- You cannot stop printing data that has already been processed. For this reason, printing may continue for a few pages after you press [JobReset].
- A print job containing a large volume of data may take considerable time to stop.

3

Mac OS - Canceling a Print Job from the computer

1. Double-click the printer icon on the desktop.

A window appears showing all print jobs that are currently queuing to be printed. Check the current status of the job you want to cancel.

Under Mac OS X, start Print Center.

2. Select the name of the job you want to cancel.

3. Click the pause icon, and then click the trash icon.

↓ Note

- If the printer is shared by multiple computers, be careful not to accidentally cancel someone else's print job.
- If the printer is connected to the computer using a parallel cable, sent print jobs may be canceled if [JobReset] is pressed while "Please wait..." is displayed on the control panel. After the interval set in [I/O Timeout] in Printer Features has passed, the next print job can be sent. A print job sent from a different client computer will not be canceled in this case.
- You cannot stop printing data that has already been processed. For this reason, printing may continue for a few pages after you press [JobReset].
- A print job containing a large volume of data may take considerable time to stop.

4. Direct Printing from a Digital Camera (PictBridge)

This chapter explains how to print directly from a digital camera.

What is PictBridge?

You can connect a PictBridge-compatible digital camera to this printer using a USB cable. This allows you to print photographs taken using the digital camera directly by operating the digital camera.

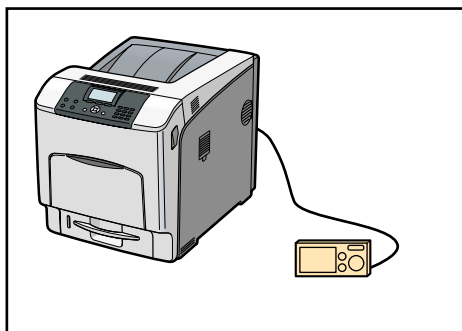

BYK073

↓ Note

- Check your digital camera is PictBridge-compatible.
- Up to 999 images can be sent from the digital camera to the printer during one print transaction. If an attempt is made to send more images, an error message is sent to the camera and printing fails.
- Since printing conditions are specified on the digital camera, specifiable parameters depend on the particular digital camera. For details, see your digital camera's manual.

PictBridge Printing

Use the following procedure to start PictBridge printing on this printer.

★ Important

- Do not disconnect the USB cable while data is being sent. If you do, printing will fail.
- The USB host interface board is supplied with a USB cable and a hook onto which you can roll up and hang the cable.

1. Check the printer and the digital camera are both switched on.
2. Connect a USB cable between the printer and the digital camera.

The data in indicator on the printer blinks for several seconds, and "PctBrdg" is displayed on the printer. This indicates that the printer has correctly recognized the digital camera.

3. On your digital camera, select the images you want to print, and specify the printing conditions.
4. The printer receives settings from the digital camera and starts printing.

↓ Note

- Since printing conditions are specified on the digital camera, specifiable parameters depend on the particular digital camera. For details, see the digital camera's manual.
- Some digital cameras require settings for manual PictBridge operation. For details, see your digital camera's manual.
- For details about connection instructions, see "Digital Camera Connection", Hardware Guide.

What Can be Done on This Printer

This printer can perform the following functions using its PictBridge feature.

The settings available for these functions are as follows:

- Single image printing
- Selected image printing
- All image printing
- Index printing
- Trimming
- Date and file name printing
- Paper size
- Image print size
- Multi-Image-Layout
- Duplex printing
- Printing quality
- Color matching
- Paper type specification
- Form printing
- Toner saving
- Camera memo printing

↓ Note

- This printer does not support the following settings:
 - DPOF printing
 - Margin-less printing
- The setting parameters and their names may vary depending on the digital camera. For details, see your digital camera's manual.



Index Printing

A4 (210 × 297 mm)

Horizontal images × Vertical images (in)	Paper orientation
8 × 12	☐



Horizontal images × Vertical images (in)	Paper orientation
12 × 8	

A5 (148 × 210 mm)

Horizontal images × Vertical images (in)	Paper orientation
5 × 8	
8 × 5	

4

Letter (8¹/₂" × 11")

Horizontal images × Vertical images (in)	Paper orientation
8 × 10	
10 × 8	

Note

- Index printouts vary depending on the orientation of the paper placed on the specified size tray.
- Depending on the digital camera, a form feed may be inserted after one set of images belonging to one type ends.
- The number of images in each size of paper is fixed.

Trimming

Use this function to print only inside of the trimming area specified on the digital camera.

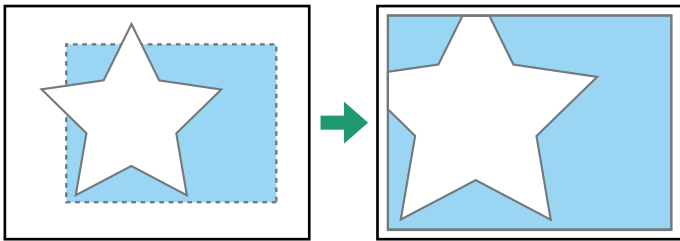

BYK507

* 1 - - Trimming area

Date and File Name Printing

Use this function to print the date and/or file name under the image.

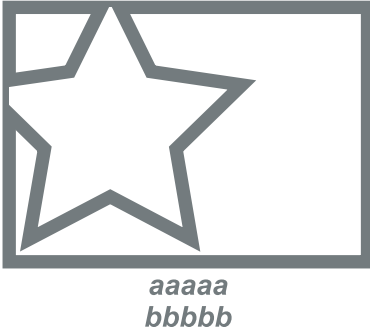

In the above figure, "aaaaa" indicates the file name and "bbbbbb" indicates the date.

4

Paper Size

Use this function to print on paper with the size specified on the digital camera.

Paper size name	Actual size
Postcard	148 mm × 100 mm
Letter (8 ¹ / ₂ " × 11 ")	279.4 mm × 216 mm (8 ¹ / ₂ × 11)
A4	297 mm × 210 mm
A5	210 mm × 148 mm
A6	148 mm × 105 mm
B5	257 mm × 182 mm
B6	182 mm × 128 mm

↓ Note

- Specify Undefined Size for the A6, B5, and B6 sizes.
- For details about specifying undefined sizes, see Hardware Guide.

Image Print Size

Use this function to print images with the size specified on the digital camera.

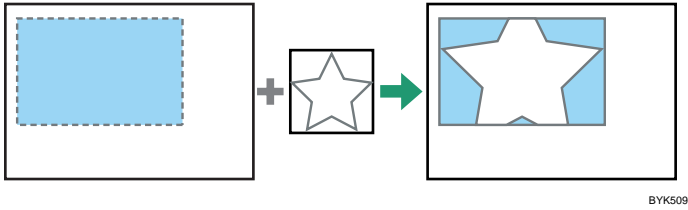

- - indicates the image size specified on the camera.

You can specify the following image print sizes:

Fixed size

- 3.25 " × 2.5 "
- 5 " × 3.5 "
- 6 " × 4 "
- 7 " × 5 "
- 10 " × 8 "
- 254 mm × 178 mm
- 110 mm × 74 mm
- 89 mm × 55 mm
- 148 mm × 100 mm
- 8 cm × 6 cm
- 10 cm × 7 cm
- 13 cm × 9 cm
- 15 cm × 10 cm
- 18 cm × 13 cm
- 21 cm × 15 cm
- 24 cm × 18 cm

↓ Note

- An error occurs if the specified size is larger than the actual paper size.

Multi-Image-Layout

Use this function to print multiple images on the specified paper.

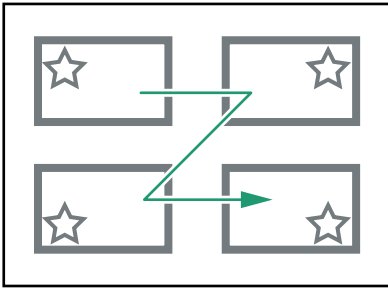

BYK510

The number of images that can be printed on one page are as follows:

Paper size	Number of images that can be specified
Postcard	2, 4
Letter (8 ¹ / ₂ " × 11")	2, 4, 8, 9, 16, 25, 32
A4	2, 4, 8, 9, 16, 25, 32
A5	2, 4, 8, 9, 16
A6	2, 4, 8
B5	2, 4, 8, 9, 16, 25
B6	2, 4, 8, 9

4

The number and arrangement of images that can be specified are as follows:

Number of images	Vertical images × Horizontal images	Paper orientation
2	2 × 1	Portrait
4	2 × 2	Portrait
8	4 × 2	Portrait
9	3 × 3	Portrait
16	4 × 4	Portrait
25	5 × 5	Portrait
32	8 × 4	Portrait

Note

- A form feed may be inserted between images depending on the digital camera in use.
- Printing in the specified way may not be possible depending on the specification for the number of images to be printed.

Duplex Printing

Use this function to enable duplex (double-sided) printing.

Duplex printing is disabled by default. When duplex printing is enabled, the printed pages open to the left. You cannot change the opening direction to the right.

Note

- Duplex printing might not be possible, depending on the paper type or the tray that the paper is being fed from.

Printing Quality

Use this function to print images at the selected printing quality.

If you select [Default] or [Normal], the machine prints at 600 dpi × 600 dpi (2 bit); if you select [Fine], the machine prints at 1200 dpi × 1200 dpi (1 bit).

Color Matching

Use this function to optimize colors when printing images.

If you select [Default] or [OFF], the machine prioritizes gradation for color matching, if you select [ON], the machine prioritizes saturation.

Paper Type Specification

This function sends the printer's paper type information to the digital camera. The names of paper types displayed on the digital camera's screen are different to the names displayed on the printer. Use the table below to match the paper types.

To display a paper type name on the digital camera's screen, use the printer's control panel to set the paper type of the printer correctly.

Paper type detected by the digital camera	Paper type of the printer
Default	All Paper types

Paper type detected by the digital camera	Paper type of the printer
Plain Paper	Plain or recycled paper
Photo Paper	HG plain paper or inkjet postcard
Fast Photo Paper	Glazed paper

Form Printing

Use this function to print images in a predetermined layout format.

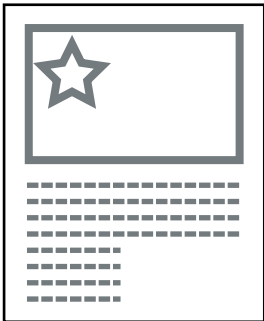

BYK511

4

Toner Saving

By specifying the print density on the digital camera, you can save on toner when printing.

Specification on the digital camera	Print density
Default/OFF	100%
Slightly light	75%
Light	50%

Camera Memo Printing

Use this function to print text data together with an image if it is attached to the image.

Exiting PictBridge

Follow the procedure below to quit the PictBridge mode.

★ Important

- Do not disconnect the USB cable while data is being sent to the printer. If you do, printing will fail.
1. Check the control panel of this printer is displaying the "Ready" state.
 2. Disconnect the USB cable from the printer.

When PictBridge Printing Does Not Work

This section explains likely causes and possible solutions for problems that can occur when PictBridge printing.

Problem	Cause	Solution
PictBridge is not available.	There is a problem with the USB connection or the PictBridge settings.	Use the following procedure to check the connection and settings: <ol style="list-style-type: none"> 1. Disconnect and then reconnect the USB cable. 2. Check the PictBridge settings are enabled. 3. Disconnect the USB cable, and then turn off the printer. Turn the printer back on. When the printer has fully booted up, reconnect the USB cable.
When two or more digital cameras are connected, the second and subsequent cameras are not recognized.	You have connected multiple digital cameras.	Connect one digital camera only. Do not connect multiple cameras.
Printing is disabled.	The number of originals exceeds the maximum number of pages that can be printed at a time.	The maximum specifiable print quantity at a time is 999. Respecify the quantity to 999 or less, and then retry printing.
Printing is disabled.	There is no paper of the specified size remaining.	There is no paper of the specified size remaining. If you have to use paper that is not of the specified size, perform Form Feed. To cancel printing, perform Job Cancel.
Printing is disabled.	The paper size setting for this tray cannot be printed on the printer.	Select the paper size setting that can be printed on the printer.

Other Reference Information

For further details about printing on this printer, see the following:

↓ Note

- For details about paper size, paper type, or tray settings, see Hardware Guide.

5. Making Printer Settings Using the Control Panel

This chapter explains the menu displayed on the control panel and how to change the printer's settings.

Menu Chart

This section explains how to change the default settings of the printer and provides information about the parameters included in each menu.

Memory Erase Status

Displays data status inside the memory.

This menu can be selected only when the optional Data overwrite security unit is installed.

Paper Input

Menu
Paper Size: Bypass Tray
Paper Size: Tray 1
Paper Size: Tray 2
Paper Size: Tray 3
Paper Size: Tray 4
Paper Type: Bypass Tray
Paper Type: Tray 1
Paper Type: Tray 2
Paper Type: Tray 3
Paper Type: Tray 4
Duplex Tray
Auto Tray Select
Tray Priority

Note

- Only installed trays appear on the display panel.

Maintenance

Menu
Quality Maintenance
General Settings
Timer Settings
HDD Management
Machine Settings Export

Note

- [HDD Management] appears only when the hard disk is installed.

5

List/Test Print

Menu
Multiple Lists
Config. Page
Error Log
Network Summary
Supply Info List
Menu List
Color Demo Page
PCL Config./Font Page
PS Config./Font Page
PDF Config./Font Page
Hex Dump

System

Menu
Print Error Report

Menu
Auto Continue
Memory Overflow
Printer Language
Sub Paper Size
Default Printer Lang.
Panel Off
Energy Saver
Auto Off
Print Compressed Data
Memory Usage
B&W Page Detect
Spool Printing
RAM Disk
Auto E-mail Notify

Note

- [Spool Printing] appears only when the hard disk is installed.
- [RAM Disk] appears only when the hard disk is not installed.

Print Settings

Menu
Machine Modes
PCL Menu
PS Menu
PDF Menu

Security Options

Menu
Extended Security
Service Mode Lock
Firmware Version
Network Security Level
Auto Erase Memory Setting
Erase All Memory
Transfer Log Setting
Machine Data Encryption

5

Note

- [Service Mode Lock] may not appear depending on the setting of the printer.
- [Auto Erase Memory Setting] and [Erase All Memory] appear when the optional Data overwrite security unit is installed.
- [Machine Data Encryption] appears only when the optional HDD encryption unit is installed.

Host Interface

Menu
I/O Buffer
I/O Timeout
Network
Parallel Interface
Wireless LAN
USB Settings

Note

- [Parallel Interface] appears when the optional IEEE 1284 interface board is installed.
- [Wireless LAN] appears when the optional Wireless LAN interface unit is installed.

Shutdown

Prepares the printer for power off. To prevent damage to the hard disk or memory leading to malfunction, be sure to shutdown the printer properly before turning off the power switch.

↓ Note

- For details about shutting down the printer, see "Turning off the Power", Hardware Guide.

Language

Menu
English
German
French
Italian
Dutch
Swedish
Norwegian
Danish
Spanish
Finnish
Portuguese
Czech
Polish
Hungarian
Russian

Extended Features

This menu is not available on the printer you are using.

Memory Erase Status Menu

Displays data status inside the memory.

★ Important

- The Memory Erase Status menu appears only when the optional Data overwrite security unit is installed.

1. Press the [Menu] key.

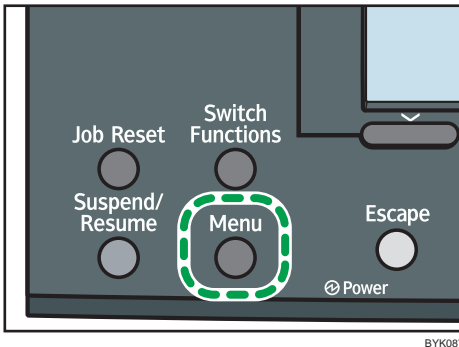

The menu screen appears.

2. Press the [▼] or [▲] key to select [Memory Erase Status], and then press the [OK] key.

3. The current memory status is displayed.

[Data to erase remaining.] : Data remain inside the memory.

[Currently no data to erase.] : No data remain inside the memory.

[Erasing Data...] : Data are being deleted.

4. Press the [OK] key.

The menu screen appears.

5. Press the [Menu] key.

The initial screen appears.

Paper Input Menu

This section explains about paper settings on the paper input menu such as paper sizes and types on each tray.

Paper Input Menu Parameters

This section explains about parameters that can be set on the paper input menu.

Paper Size: Bypass Tray

You can specify the paper size for Bypass Tray.



Default:

 **Region A** (mainly Europe and Asia)

A4

 **Region B** (mainly North America)



8 1/2 × 11

-  **Region A** (mainly Europe and Asia)
 A4, A5, A6, B5 JIS, B6 JIS, C5 Env., C6 Env., DL Env., 8 1/2 × 14, 8 1/2 × 13, 8 1/2 × 11, 8 1/4 × 13, 8 × 13, 7 1/4 × 10 1/2, 5 1/2 × 8 1/2, 4 1/8 × 9 1/2, 3 7/8 × 7 1/2, 16K, Custom Size
-  **Region B** (mainly North America)
 8 1/2 × 14, 8 1/2 × 13, 8 1/2 × 11, 8 1/4 × 13, 8 × 13, 7 1/4 × 10 1/2, 5 1/2 × 8 1/2, 4 1/8 × 9 1/2, 3 7/8 × 7 1/2, A4, A5, A6, B5 JIS, B6 JIS, C5 Env., C6 Env., DL Env., 16K, Custom Size

Paper Size: Tray 1 to 4

You can specify the paper size for Tray 1 to 4.

Default: [Auto Detect]

-  **Region A** (mainly Europe and Asia)
 Auto Detect, A4, A5, A6, B5 JIS, B6 JIS, C5 Env., C6 Env., DL Env., 8 1/2 × 14, 8 1/2 × 13, 8 1/2 × 11, 8 1/4 × 13, 8 × 13, 7 1/4 × 10 1/2, 5 1/2 × 8 1/2, 4 1/8 × 9 1/2, 3 7/8 × 7 1/2, 16K, Custom Size
-  **Region B** (mainly North America)
 Auto Detect, 8 1/2 × 14, 8 1/2 × 13, 8 1/2 × 11, 8 1/4 × 13, 8 × 13, 7 1/4 × 10 1/2, 5 1/2 × 8 1/2, 4 1/8 × 9 1/2, 3 7/8 × 7 1/2, A4, A5, A6, B5 JIS, B6 JIS, C5 Env., C6 Env., DL Env., 16K, Custom Size

Note

- JIS stands for "Japanese Industrial Standard".

Paper Type: Bypass Tray

Default: **[No Display (Plain Paper)]**

For details about the types of paper that can be loaded in the Bypass Tray, see Hardware Guide.

Be sure to set a paper type using the control panel. If you do not set it, the printing result might not be proper.

No Display (Plain Paper), Recycled Paper, Special Paper 1, Special Paper 2, Special Paper 3, Letterhead, Label Paper, OHP (Transparency), Envelope, Coated Paper (Glossy), Coated Paper (Glossy : Thick), Coated Paper (Matted), Coated Paper(Matted : Thick), Preprinted Paper, Thin Paper, Middle Thick, Thick Paper 1, Thick Paper 2, Thick Paper 3, Thick Paper 4, Waterproof Paper, +Custom 1, +Custom 2, +Custom 3, +Custom 4, +Custom 5, +Custom 6, +Custom 7, +Custom 8

Paper Type: Tray 1 to 4

Default: **[No Display (Plain Paper)]**

For details about the types of paper that can be loaded in each tray, see Hardware Guide.

Be sure to set a paper type using the control panel. If you do not set it, the printing result might not be proper.

Only installed trays appear on the display panel.

No Display (Plain Paper), Recycled Paper, Special Paper 1, Special Paper 2, Special Paper 3, Letterhead, Label Paper, Envelope, Coated Paper (Glossy), Coated Paper(Glossy : Thick), Coated Paper (Matted), Coated Paper(Matted : Thick), Preprinted Paper, Thin Paper, Middle Thick, Thick Paper 1, Thick Paper 2, Thick Paper 3, Waterproof Paper, +Custom 1, +Custom 2, +Custom 3, +Custom 4, +Custom 5, +Custom 6, +Custom 7, +Custom 8

Duplex Tray

You can set each tray for duplex printing. Only installed trays appear on the display panel.

- Tray 1 to Tray 4, Bypass Tray

Default: **[On]**

- On
- Off

Auto Tray Select

You can select whether to assign each tray to automatically print the paper size and type set by printer driver.

- Tray 1 to Tray 4

Default: **[On]**

- On
- Off

- Bypass Tray

Default: [Off]

- On
- Off

↓ Note

- When using custom size paper, if automatic tray selection is enabled, the size selected on the control panel has priority. If this setting is disabled, the size selected from the printer driver has priority.
- Only installed trays appear on the display panel.
- You can select multiple trays.
- If you need to have a tray locked, you must select the tray using both printer driver and control panel.

Tray Priority

You can set a tray to be checked first when automatic tray selection is enabled from the printer driver. The tray selected here is used when no tray is selected for a print job.

Default: [Tray 1]

↓ Note

- Only installed trays appear on the display panel.
- It is recommended that you load paper of the size and orientation you use most frequently in the tray selected in this setting.

5

Changing the Paper Input Menu

Automatic tray selection

Follow the procedure below to change the automatic tray selection setting.

1. Press the [Menu] key.

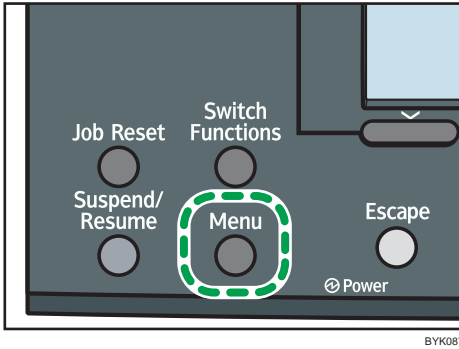

The menu screen appears.

2. Press the [▼] or [▲] key to select [Paper Input], and then press the [OK] key.
3. Press the [▼] or [▲] key to select [Auto Tray Select], and then press the [OK] key.
4. Press the [▼] or [▲] key to select the tray you want to print from, and then press the [OK] key.
5. Press the [▼] or [▲] key to select [On], and then press the [OK] key.
Wait for one second. The [Auto Tray Select] screen appears.
6. Press the [Menu] key.

The initial screen appears.

Tray priority

Follow the procedure below to change the tray priority.

1. Press the [Menu] key.

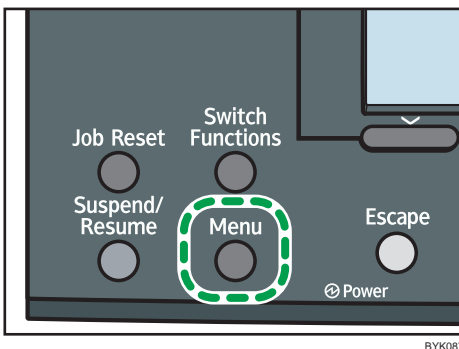

The menu screen appears.

2. Press the [▼] or [▲] key to select [Paper Input], and then press the [OK] key.
3. Press the [▼] or [▲] key to select [Tray Priority], and then press the [OK] key.

4. Press the [▼] or [▲] key to select a tray you want to use, and then press the [OK] key.

Wait for one second. The [Paper Input] screen appears.

5. Press the [Menu] key.

The initial screen appears.

Maintenance Menu

You can set printing conditions such as density and calibration, and printer management such as deleting temporary print jobs from the hard disk.

Maintenance Menu Parameters

This section explains about parameters that can be set on the maintenance menu.

Quality Maintenance

Color Registration

You can perform automatic adjustment of color registration.

Color Calibration

You can adjust the gradation of bright (highlighted parts) and medium areas (middle parts) for printing.

- Adjust Auto Density
You can print the gradation of auto density.
- Print Test Pattern 1
You can print gradation correction sheet 1.
- Print Test Pattern 2
You can print gradation correction sheet 2.
- Reset Setting
You can reset the gradation correction value to default.

⬇ Note

- For details, see Hardware Guide.

Registration

You can adjust the starting position of the printing page.

- Print Test Sheet
You can print the registration test sheet.
Default: [Tray 1]
 - Tray 1
 - Tray 2
 - Tray 3
 - Tray 4

- Bypass Tray
- Duplex Unit

Note

- Only the installed trays appear on the display panel.
- Adjustment

You can select the start position for printing on a page.

Horizontal: Tray 1 to 4, Horizontal: Bypass Tray, Horizontal:Back Side

Note

- Only the installed trays appear on the display panel.

4 Color Graphic Mode

This mode adjusts levels of toner color overlap. If characters or lines blur, setting priority on text may make them clearer. Under normal conditions, set priority on photo.

Default: **[Photo Priority]**

- Text Priority
- Photo Priority

General Settings

Plain Paper Setting

You can select the type of plain paper.

- Tray 1 to 4, Bypass Tray

Default: **[Plain Paper 2]**

- Plain Paper 1
- Plain Paper 2

Letterhead Setting

You can select the letterhead printing mode.

- Tray 1 to 4, Bypass Tray

Default: **[Letterhead 2]**

- Letterhead 1
- Letterhead 2
- Letterhead 3
- Letterhead 4
- Letterhead 5

Coated Paper (Glossy) Stg.

You can select the coated paper (glossy) setting mode.

- Tray 1 to 4, Bypass Tray

Default: [Coated Paper (Glossy) 4]

- Coated Paper (Glossy) 1
- Coated Paper (Glossy) 2
- Coated Paper (Glossy) 3
- Coated Paper (Glossy) 4
- Coated Paper (Glossy) 5

Coated Paper(Glossy : Thick)

You can select the coated paper (glossy : thick) setting mode.

- Bypass Tray

Default: [CoatedPaper(Glossy : Thick)1]

- CoatedPaper(Glossy : Thick)1
- CoatedPaper(Glossy : Thick)2

Coated Paper (Matted) Stg.

You can select the coated paper (matted) setting mode.

- Tray 1 to 4, Bypass Tray

Default: [Coated Paper (Matted) 4]

- Coated Paper (Matted) 1
- Coated Paper (Matted) 2
- Coated Paper (Matted) 3
- Coated Paper (Matted) 4
- Coated Paper (Matted) 5

Coated Paper(Matted : Thick)

You can select the coated paper (matted : thick) setting mode.

- Bypass Tray

Default: [CoatedPaper(Matted : Thick)1]

- CoatedPaper(Matted : Thick)1
- CoatedPaper(Matted : Thick)2

Waterproof Paper Setting

You can select the waterproof paper setting mode.

- Tray 1 to 4, Bypass Tray

Default: [**Waterproof Paper 5**]

- Waterproof Paper 1
- Waterproof Paper 2
- Waterproof Paper 3
- Waterproof Paper 4
- Waterproof Paper 5

Label Paper Setting

You can select the label paper setting mode.

- Tray 1 to 4, Bypass Tray

Default: [**Label Paper 6**]

- Label Paper 1
- Label Paper 2
- Label Paper 3
- Label Paper 4
- Label Paper 5
- Label Paper 6

5

Envelope Setting

You can select the envelope setting mode.

- Tray 1 to 4, Bypass Tray

Default: [**Envelope 1**]

- Envelope 1
- Envelope 2
- Envelope 3
- Envelope 4

Replacement Alert

Use this function to specify the timing to notify user when supplies need to be replaced. Settings can be made separately for photo conductor unit, intermediate transfer unit, or fusing unit.

- Photoconductor Unit

Default: [**Normal**]

- Notify Sooner
- Normal
- Notify Later

- Intermediate Transfer Unit

Default: [**Normal**]

- Notify Sooner
- Normal
- Notify Later
- Fusing Unit

Default: [**Normal**]

- Notify Sooner
- Normal
- Notify Later

Supply End Option

You can specify whether or not to continue printing after the following components have exceeded their recommended service life.

- Drum Unit
- Transfer Unit
- Fusing Unit

Default: [**Continue Printing**]

- Continue Printing
- Stop Printing

Display Supply Info

You can select whether or not the amount of toner is displayed on the initial screen.

Default: [**On**]

- On
- Off

Menu Protect

You can select whether or not to protect the menu settings. If you enable this setting, you must specify a protection level.

Default: [**Level 2**]

- Level 1
- Level 2
- Off

↓ Note

- If you would like to lower the protection level, disable this setting or select [Level 1].
- You may not be able to change this setting depending on the setting of the printer.

List/Test Print Lock

You can select whether or not to prohibit List/Test printing.

Default: [Off]

- On
- Off

↓ Note

- You may not be able to change this setting depending on the setting of the printer.

Unit of measure

You can specify the unit for measurement.

Default:

 **Region A** (mainly Europe and Asia)

[mm]

 **Region B** (mainly North America)

[inch]

- mm
- inch

Panel Key Sound

You can select whether or not to enable the panel key sound.

Default: [On]

- On
- Off

Warm-up Beeper

You can select whether or not to sound the beeper when the printer has completed a warm-up process.

Default: [Off]

- On
- Off

Display Contrast

You can specify the density of the display.

Key Repeat

You can specify whether or not to scroll the display panel when the [▼] or [▲] key is held down. When you enable this setting, specify the scroll speed. (If repeat time is set to "Long", scroll speed becomes slow.)

Default: [Normal]

- Do not Repeat

- Normal
- Repeat Time: Medium
- Repeat Time: Long

Function Priority

Specify the function that is selected by default whenever the printer is turned on or leaves Energy Saver mode.

The order of the items on this menu reflects the order of the functions that appear when [Switch Functions] is pressed.

Default: **[Printer]**

- Printer
- Extended Features 1
- Extended Features 2
- Extended Features 3

5

Timer Settings

Auto Reset Timer

Specify whether or not to cancel settings made if no operation has been performed for a certain period of time while changing configuration using the control panel. When set to on, specify how long the printer is to wait before resetting configuration.

Default: **[On]** (60 seconds)

- On
- Off

Set Date

Set the date for the printer's internal clock using the number keys.

To change between year, month, and day, press [▶] and [◀].

Set Time

Set the time for the printer's internal clock using the number keys.

HDD Management

Specify the settings related to deletion of data saved on the hard disk. This menu appears only if the hard disk is installed.

Delete All Temporary Jobs

Use this function to delete all temporary documents saved on the hard disk (Sample Print, Locked Print, and Hold Print data) at once.

Delete All Stored Jobs

Use this function to delete all Stored Print data saved on the hard disk at once.

Auto Delete Temporary Jobs

Specify whether or not to automatically delete temporary documents saved on the hard disk (Sample Print, Locked Print, and Hold Print data). When set to on, specify how long the printer is to wait before deleting the documents.

Default: [Off]

- On
- Off

↓ Note

- If you enable this setting, specify the timer in hours. (Default: 8 hours)

Auto Delete Stored Jobs

Specify whether or not to automatically delete Stored Print data saved on the hard disk. When set to on, specify how long the printer is to wait before deleting the documents.

Default: [On]

- On
- Off

↓ Note

- If you enable this setting, specify the timer in days. (Default: 3 days)

Machine Settings Export

Use this function to store the machine's configuration settings on an SD card. Information stored on the card can be used to restore the machine's configuration. The card can also be used to export this machine's configuration settings to another machine of the same manufacturer.

The settings under [Option], [Paper Input], [Maintenance], [System], [Print Settings], and [Host Interface] can be exported. Note that only settings common to both the source and target machines can be exported using the card. To import the stored settings, make sure the target printer's power is turned off, and then insert the SD card into slot of the target printer. Then, while pressing the [Job Reset] key, turn on the power of the target printer.

↓ Note

- For details about inserting the SD card and the location of the slot, see the manual that explains the features of your printer's hardware.
- For details about the machines to which settings can be exported using an SD card, consult the manufacturer.

Changing the Maintenance Menu

This section explains changing the maintenance menu using examples.

Automatic deletion of temporary jobs in the hard disk

Follow the procedure below to set automatic deletion of temporary jobs stored in the hard disk.

1. Press the [Menu] key.

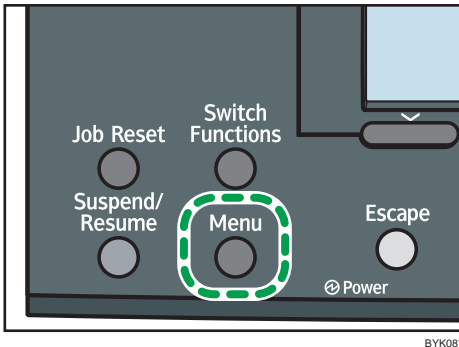

The menu screen appears.

2. Press the [▼] or [▲] key to select [Maintenance], and then press the [OK] key.
3. Press the [▼] or [▲] key to select [HDD Management], and then press the [OK] key.
4. Press the [▼] or [▲] key to select [Auto Delete Temporary Jobs], and then press the [OK] key.
5. Press the [▼] or [▲] key to select [On], and then press the [OK] key.
6. Press the [▼] or [▲] key to set automatic deletion timer in hours between 1 through 200.
7. Press the [OK] key.

Wait for one second. The hard disk management screen appears.

8. Press the [Menu] key.

The initial screen appears.

List/Test Print Menu

The list/test print menu allows you to print lists showing the printer configuration and the setting status of print-related conditions.

List/Test Print Menu Parameters

This section explains about parameters that can be set on the list/test print menu.

Multiple Lists

You can print the configuration page and error log, network summary and supply list.

Config. Page

You can print the current configuration of the printer.

Error Log

You can print an error report.

Network Summary

You can print the network device status.

Supply Info List

You can print the supply status.

Menu List

You can print a menu list showing all available menus.

Color Demo Page

You can print a color demonstration page.

PCL Config./Font Page

You can print the current configuration and installed PCL font list.

PS Config./Font Page

You can print the current configuration and installed PostScript font list.

PDF Config./Font Page

You can print the current configuration and installed PDF font list.

Hex Dump

You can print the data sent by the computer using Hex Dump.

Printing a Configuration Page

Follow the procedure below to print the configuration page.

★ Important

- The configuration page is printed on A4 or Letter (8 1/2"×11") size paper, so load them in the same paper tray.

1. Press the [Menu] key.

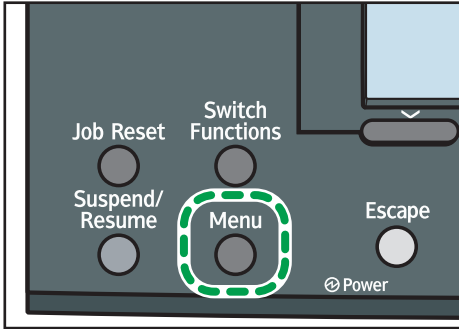

5

The menu screen appears.

2. Press the [▼] or [▲] key to select [List/Test Print], and then press the [OK] key.
3. Press the [▼] or [▲] key to select [Config. Page], and then press the [OK] key.

After the configuration page is printed out, the screen returns to List/Test print menu.

4. Press the [Menu] key.

The initial screen appears.

Interpreting the Configuration Page

System Reference

Machine ID

Shows the serial number assigned to the board by its manufacturer.

Total Memory

Shows the total memory status.

Total Counter

Shows the total number of pages printed by the printer to date.

Firmware Version

- Printer
Shows the version number of the printer controller firmware.
- System
Displays the version number of the system firmware.

- Engine
Shows the version number of the printer engine firmware.
- NIB
Shows the version number of the network interface board.

Device Connection

Shows the names of device options installed in the printer.

HDD: Font/Macro Download

Shows the hard disk status.

Printer Language

Shows the version number of the printer language.

Attached Equipment

Shows the options attached to the printer.

Paper Input

Shows the current Paper Input settings.

Note

- For details, see "Paper Input Menu".

Reference

- p.105 "Paper Input Menu"

Maintenance

Shows the current Maintenance settings.

Note

- For details, see "Maintenance Menu".

Reference

- p.110 "Maintenance Menu"

System

Shows the current System settings.

Note

- For details, see "System Menu".

Reference

- p.124 "System Menu"

Machine Modes

Shows the current machine modes settings.

 **Note**

- For details, see "Print Settings Menu".

 **Reference**

- p.130 "Print Settings Menu"

PCL Menu

Shows the current PCL settings.

 **Note**

- For details, see "Print Settings Menu".

 **Reference**

- p.130 "Print Settings Menu"

PS Menu

Shows the current PS settings.

 **Note**

- For details, see "Print Settings Menu".

 **Reference**

- p.130 "Print Settings Menu"

PDF Menu

Shows the current PDF settings.

 **Note**

- For details, see "Print Settings Menu".

 **Reference**

- p.130 "Print Settings Menu"

Host Interface

Shows the current Host Interface settings.

When DHCP is active on the network, the IPv4 address, subnet mask, and gateway address appear in parentheses.

 **Note**

- For details, see "Host Interface Menu".

 **Reference**

- p.145 "Host Interface Menu"

Interface Information

Interface information is displayed.

User Paper Type

Registered user paper types are displayed.

System Menu

The system menu allows you to set the printer's basic functions. Although you can operate the printer using the default settings, you can also change its settings to better suit your printing needs. Changes made to settings remain effective after power off.

System Menu Parameters

This section explains about parameters that can be set on the system menu.

Print Error Report

Select whether or not to print an error report when a printer error or memory error occurs.

Default: [Off]

- On
- Off

Auto Continue

Specify whether or not to continue printing after a system error. When you enable this setting, specify how long the printer is to display error before resuming print.

Default: [Off]

- Off
- Immediate
- 1 minute
- 5 minutes
- 10 minutes
- 15 minutes

↓ Note

- When [Auto Continue] is set to on, and a certain error occurs in the printer while printing, the job might be cancelled, or printing will not be as intended. When a job is cancelled due to error, the printer automatically begins the next job in the queue.

Memory Overflow

You can specify whether or not to print a memory overflow error report.

Default: [Do not Print]

- Do not Print
- Error Information

Printer Language

You can specify the printer language.

Default: **[Auto]**

- Auto
- PCL
- PS
- PDF

Sub Paper Size

Specify whether or not to use paper of the alternate size automatically, if paper of the specified size is not loaded. When this setting is set to off, the printer uses paper of any size loaded in the specified tray.

Default: **[Auto]**

- Auto
- Off

Default Printer Lang.

Select the printer language to use when the printer fails to detect the printer language.

Default: **[PCL]**

- PCL
- PS
- PDF

Panel Off

You can specify whether or not to switch panel off.

Panel Off On/Off

Default: **[On]**

- On
- Off

Panel Off Timer

Default: **[10 seconds]**

- 10 seconds
- 1 minute
- 5 minutes
- 15 minutes
- 30 minutes
- 45 minutes

Energy Saver

You can specify the number of minutes Energy Saver mode is applied.

Energy Saver On/Off

You can specify whether or not to switch energy saver.

Default: [On]

- On
- Off

Note

- When the printer switches to energy saver mode, the Power indicator is unlit, but the Online indicator remains lit.

Energy Saver Timer

Specify the lead time needed to switch to energy saver mode.

Default: [1 minute]

- 30 seconds
- 1 minute
- 5 minutes
- 15 minutes
- 30 minutes
- 45 minutes
- 60 minutes

Auto Off

You can specify whether or not to switch Auto Off.

Auto Off On/Off

Default: [On]

- On
- Off

Auto Off Timer

Default: [11 minutes]

- 1 minute
- 5 minutes
- 11 minutes
- 15 minutes
- 30 minutes
- 45 minutes
- 60 minutes

Print Compressed Data

Specify whether or not to print compressed data.

Default: [Off]

- On
- Off

Memory Usage

Select memory to be used from Font Priority or Frame Priority.

Default: [Frame Priority]

- Font Priority
- Frame Priority

B&W Page Detect

Specify whether to recognize black-and-white images by page or by document. Black-and-white recognition function allows the printer to print monochrome images in monochrome mode even if color printing is specified.

Default: [Per Job]

- Per Page
- Per Job

Spool Printing

Specify whether or not to complete spooling before starting to print.

Default: [Off]

- On
- Off

Note

- Spooling stores a sent print job temporarily in the printer, and then prints it.
- This function is available only if the hard disk is installed on the printer.

RAM Disk

If the hard disk is not installed for PDF Direct Print, select a value of 2 MB or higher.

Default: [4 MB]

- 0 MB
- 2 MB
- 4 MB
- 8 MB

Note

- This function is displayed only on Type 1 models that have no hard disk installed.
- For details about the optional SDRAM module, see Hardware Guide.

Auto E-mail Notify

Specify whether or not to send an error message to a preset e-mail address when an error occurs in the printer.

Important

- After changing the setting, turn off the power of the printer briefly, and then turn it on again.

Default: [On]

- On
- Off

Note

- For information, see Web Image Monitor Help.

5

Changing the System Menu

Follow the procedure below to change the settings for Energy Saver Timer.

1. Press the [Menu] key.

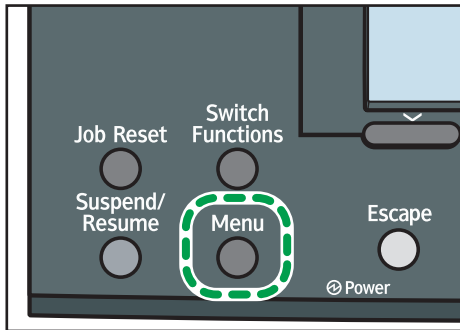

The menu screen appears.

2. Press the [▼] or [▲] key to select [System], and then press the [OK] key.
3. Press the [▼] or [▲] key to select [Auto Off], and then press the [OK] key.
4. Press the [▼] or [▲] key to select [Auto Off Timer], and then enter the [OK] key.
5. Press the [▼] or [▲] key to select the lead time needed to switch to auto off mode.
6. Press the [OK] key.

Wait for one second. The Auto Off appears.

7. Press the [Menu] key.

The initial screen appears.

Print Settings Menu

The System Menu allows you to set conditions for printing.

Print Settings Menu Parameters

This section explains about parameters that can be set on the print settings menu.

Machine Modes

Copies

Specify the number of copies to print.

If the number of copies to print is specified by command or the printer driver, this setting is overridden.

- 1 to 999

Page Size

Specify the default paper size.

Default:



 **Region A** (mainly Europe and Asia)

A4

 **Region B** (mainly North America)

8¹/₂ × 11

Note

- The default paper size is used when the paper size is not specified in the print data.
-  **Region A** (mainly Europe and Asia)
A4, A5, A6, B5 JIS, B6 JIS, C5 Env., C6 Env., DL Env., 8¹/₂ × 14, 8¹/₂ × 13, 8¹/₂ × 11, 8¹/₄ × 13, 8 × 13, 7¹/₄ × 10¹/₂, 5¹/₂ × 8¹/₂, 4¹/₈ × 9¹/₂, 3⁷/₈ × 7¹/₂, 16K, Custom Size
-  **Region B** (mainly North America)
8¹/₂ × 14, 8¹/₂ × 13, 8¹/₂ × 11, 8¹/₄ × 13, 8 × 13, 7¹/₄ × 10¹/₂, 5¹/₂ × 8¹/₂, 4¹/₈ × 9¹/₂, 3⁷/₈ × 7¹/₂, A4, A5, A6, B5 JIS, B6 JIS, C5 Env., C6 Env., DL Env., 16K, Custom Size

Edge to Edge Print

Select to whether or not to print using the whole area of paper, leaving no edge borders.

Default: [Off]

- On
- Off

Duplex

Select whether or not to print on both sides of a sheet. When set to on, specify the binding method.

Default: [Off]

- Off
- Long Edge Bind
- Short Edge Bind

Rotate by 180 Degrees

Select whether or not to rotate image by 180 degrees when printing.

Default: [Off]

- On
- Off

Blank Page Print

Select whether or not to print blank pages.

Default: [On]

- On
- Off

Letterhead Setting

Specify whether or not to print with the letterhead printing mode.

Default: [Auto Detect]

- Off
Not printing with the letterhead printing mode.
- Auto Detect
Print with the letterhead printing mode when the letterhead printing mode is selected.
- On (Always)
Print with the letterhead printing mode regularly.

Tray Setting Priority

Specify whether the paper size and type settings that are applied are those specified using the control panel, printer driver, or print command.

- Bypass Tray
Specify whether the paper size and type settings applied for bypass Tray are those specified using the control panel, printer driver, or print command.
Default: [Driver/Command]
 - Driver/Command

When the source paper tray is specified for a print job, the paper settings specified using the printer driver or by print command are applied, regardless of any settings specified using the control panel.

- Machine Setting(s)

The paper settings specified on the machine's control panel are applied to all print jobs. An error will occur if the paper settings specified using the printer driver or by print command do not match those specified using the control panel.

- Any Size/Type

If the machine's trays do not contain paper matching the settings of the print job, printing can proceed from the bypass tray with the job's settings applied.

- Any Custom Size/Type

If the machine's trays do not contain paper matching the settings of the print job but custom paper was specified using the printer driver or by print command, printing can proceed from the bypass tray with the job's settings applied.

- Tray 1

Specify whether the paper size and type settings applied for Tray 1 are those specified using the control panel, printer driver, or print command.

Default: [**Machine Setting(s)**]

- Driver/Command
- Machine Setting(s)

- Tray 2

Specify whether the paper size and type settings applied for Tray 2 are those specified using the control panel, printer driver, or print command.

Default: [**Machine Setting(s)**]

- Driver/Command
- Machine Setting(s)

- Tray 3

Specify whether the paper size and type settings applied for Tray 3 are those specified using the control panel, printer driver, or print command.

Default: [**Machine Setting(s)**]

- Driver/Command
- Machine Setting(s)

- Tray 4

Specify whether the paper size and type settings applied for Tray 4 are those specified using the control panel, printer driver, or print command.

Default: [**Machine Setting(s)**]

- Driver/Command
- Machine Setting(s)

Tray Switching

You can specify whether or not the machine automatically switches paper trays if paper of the specified size and type is not loaded in the driver-designated tray.

Default: [Off]

- On
- Off

Extend Auto Tray Switching

This setting enables the machine to switch paper trays automatically, regardless of whether the tray is manually or automatically selected.

Default: [Off]

- On
- Off

5

PCL Menu

You can set conditions when using PCL for printing.

Orientation

Select the page orientation.

Default: [Portrait]

- Portrait
- Landscape

Form Lines

Specify the number of lines per page between 5 to 128.

Default:

 Region **A** (mainly Europe and Asia)

64

 Region **B** (mainly North America)

60

 **Note**

- The default paper size is used when the paper size is not specified in the print data.

Font Source

Specify the location of the default font.

Default: [Resident]

- Resident

- RAM
- HDD
- SD
- SD Font Download

Note

- When you select [RAM], you can select only fonts downloaded to the printer RAM.
- When you select [HDD], you can select only fonts downloaded to the hard disk.
- When you select [SD Font Download], you can select only fonts downloaded to the SD card.

Font Number

Specify the ID of the default font you want to use.

Default: 0

- 0 to 63 (Resident)
- 1 to X (Download; "X" is the number of downloaded fonts)

Point Size

Specify the point size you want to use for the default font between 4 to 999.75 in 0.25 increments.

Default: 12.00 points

Note

- This setting is effective only for a variable-space font.

Font Pitch

Specify the number of characters per inch you want to use for the default font between 0.44 to 99.99 in 0.01 increments.

Default: 10.00 pitches

Note

- This setting is effective only for fixed-space fonts.

Symbol Set

You can specify the character set for the default font. Available sets are as follows:

Roman-8, Roman-9, ISO L1, ISO L2, ISO L5, ISO L6, ISO L9, PC-775, PC-8, PC-8 D/N, PC-850, PC-852, PC-858, PC8-TK, PC-1004, Win L1, Win L2, Win L5, Win Baltic, Desktop, PS Text, MS Publ, Math-8, PS Math, Pifont, Legal, ISO 4, ISO 6, ISO 11, ISO 15, ISO 17, ISO 21, ISO 60, ISO 69, Win 3.0, MC Text, UCS-2, PC-864, Arabic-8, Win Arabic, PC-866, PC-866U, ISO Cyrillic, Win Cyrillic, PC-851, Greek-8, ISO Greek, PC-8 Greek, Win Greek, PC-862, Hebrew-7, Hebrew-8, ISO Hebrew

Default: [PC-8]

Courier Font

Select the type of courier font.

Default: [**Regular**]

- Regular
- Dark

Ext. A4 Width

Select whether or not to extend the width of the printable area of A4 sheets, by reducing side margins.

Default: [**Off**]

- On
- Off

Append CR to LF

Select whether or not to append a CR code to each LF code to print text data clearly.

Default: [**Off**]

- On
- Off

Resolution

You can specify the print resolution in dots per inch.

Default: [**600dpi Standard**]

- 600dpi Fast
- 600dpi Standard

PS Menu

You can set conditions when using PostScript for printing.

Job Timeout

You can specify how long the printer waits (in seconds) before canceling the current job when the job is interrupted while being processed.

Default: [**Use Driver/Command**]

- Use Driver/Command
- Use Machine Setting(s)

Note

- If you select Use Machine Setting(s), enter a value between 0 to 999. (Default: 0)

Wait Timeout

You can specify how long the printer waits (in seconds) before it cancels receiving a job when the printer cannot detect the end of the job.

Default: [**Use Driver/Command**]

- Use Driver/Command
- Use Machine Setting(s)

Note

- If you select Use Machine Setting(s), enter a value between 0 to 999. (Default: 300)

Data Format

Select the data format from Binary Data or TBCP.

This setting is ineffective when using a parallel or EtherTalk connection.

When using a parallel or USB connection, the print job is canceled if binary data is sent from the printer driver.

Default: [**TBCP**]

When using an Ethernet connection, the print job is canceled if:

- The printer driver data format is TBCP and the data format selected using the control panel is Binary Data.
- The printer driver data format is binary and the data format selected using the control panel is TBCP.

Resolution

Select the resolution.

Default: [**600dpi Standard**]

- 600dpi Fast
- 600dpi Standard
- 1200dpi

Color Setting

Specify the RGB setting.

Default: [**Super Fine**]

- None
- Fine
- Super Fine

Color Profile

Specify the color profile.

Default: [**Auto**]

- Auto
- Presentation
- Solid Color

- Photographic
- User Setting

Process Color Model

Specify the color model.

Default: [Color]

- Color
- Black and White

Orientation Auto Detect

Specify the orientation auto detect.

Default: [On]

- On
- Off

PDF Menu

You can set conditions when using PDF for printing.

Change PDF Password

Specify the password for the PDF file executing PDF Direct Print.

Important

- If you do not set a PDF password, this menu does not appear.
- The password can be set using Web Image Monitor, but must be sent through the network. For increased security, use this menu on the control panel to set the password directly.

PDF Group Password

This setting is not available on this printer.

Reverse Order Printing

This setting enables the document starts printing from the last page. Use this function when prints come out face up in the output tray. This allows a printed document to be assembled in page order.

Default: [Off]

- On
- Off

Resolution

Specify the resolution for the PDF file executing PDF Direct Print.

Default: [600dpi Standard]

- 600dpi Fast
- 600dpi Standard

- 1200dpi

Color Setting

Specify the RGB setting for the PDF file executing PDF Direct Print.

Default: [**Super Fine**]

- None
- Fine
- Super Fine

Color Profile

Specify the color profile for the PDF file executing PDF Direct Print.

Default: [**Auto**]

- Auto
- Presentation
- Solid Color
- Photographic
- User Setting

Process Color Model

Specify the color model for the PDF file executing PDF Direct Print.

Default: [**Color**]

- Color
- Black and White

Orientation Auto Detect

Specify the orientation auto detect for the PDF file executing PDF Direct Print.

Default: [**On**]

- On
- Off

Changing the Print Settings Menu

Follow the procedure below to change Tray Setting Priority.

1. Press the [Menu] key.

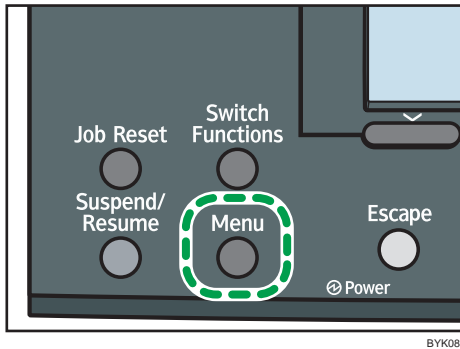

BYK087

The menu screen appears.

2. Press the [▼] or [▲] key to select [Print Settings], and then press the [OK] key.
 3. Press the [▼] or [▲] key to select [Machine Modes], and then press the [OK] key.
 4. Press the [▼] or [▲] key to select [Tray Setting Priority], and then enter the [OK] key.
 5. Press the [▼] or [▲] key to select the tray whose paper type or size you want to change, and then press the [OK] key.
 6. Press the [▼] or [▲] key to select the desired setting item, and then press the [OK] key.
- Wait for one second. The [Tray Sett. Prio. :] screen appears.
7. Press the [Menu] key.

The initial screen appears.

Security Options Menu

The system menu allows you to set conditions for printing.

Security Options Menu Parameters

This section explains about parameters that can be set on the security options menu.

Extended Security

Depending on the setting of the printer, some of the settings listed below may not appear.

Driver Encryption Key

Specify the driver encryption key.

Encrypt Address Book

Select whether or not to encrypt the printer's address book data.

Default: [Off]

- On
- Off

Restrict User Info.Display

Select whether or not to display user information as "*****" when checking job information without being authenticated through user authentication.

Default: [Off]

- On
- Off

Enhance File Protection

Select whether or not to automatically lock password-protected print files if an invalid password is entered ten times. When a file is locked, you cannot select them even if the correct password is entered.

Default: [Off]

- On
- Off

Settings by SNMPv1 and v2

Select whether or not to prohibit changes to the printer settings through access using SNMPv1, v2 protocol.

Default: [Do not Prohibit]

- Prohibit

- Do not Prohibit

Simple Encryption

Select whether or not to use apply simple encryption (restrict usage) when enhanced encryption cannot be used.

Default: [**Do not Restrict**]

- Restrict
- Do not Restrict

Authenticate Current Job

Select whether or not authentication is required for operations such as canceling jobs. If set to [Login Privilege], only authorized users or your administrator can operate the printer. If set to [Access Privilege], users who sent a print job or your administrator can operate the printer.

Default: [**Off**]

- Login Privilege
- Access Privilege
- Off

Password Policy

Specify the format of passwords: types of characters to be used and minimum length.

Valid characters for passwords are upper-case letters, lower-case letters, decimal numbers, and symbols such as #. If complexity is set to [Level 1], passwords must use two types of these characters; if set to [Level 2], three types.

- Complexity Setting

Default: [**Do not Restrict**]

- Minimum Character No.
Between 0 to 32

Default: **0**

Note

- If set to 0, minimum length is not specified.

@Remote Service

Select whether or not to prohibit @Remote Service.

Default: [**Do not Prohibit**]

- Prohibit
- Do not Prohibit

Note

- If you would like to set to Prohibit, contact your service representative.

Update Firmware

Select whether or not to prohibit Update Firmware.

Default: [**Do not Prohibit**]

- Prohibit
- Do not Prohibit

↓ Note

- If you would like to set to Prohibit, contact your service representative.

Change Firmware Structure

Select whether or not to prohibit Change Firmware Structure.

Default: [**Do not Prohibit**]

- Prohibit
- Do not Prohibit

↓ Note

- If you would like to set to Prohibit, contact your service representative.

Service Mode Lock

Select whether or not to prohibit entering service mode.

Default: [**Off**]

- On
- Off

↓ Note

- This setting may not appear depending on the setting of the printer.

Firmware Version

Display the firmware version of the printer.

Network Security Level

Specify the network security level.

Default: [**Level 0**]

- Level 0
- Level 1
- Level 2

Auto Erase Memory Setting

Select whether or not to automatically delete memory. When set to on, specify the overwrite times.

Default: [**Off**]

- On

Number of Erase: Between 1 to 9

- Off

Note

- This setting appears only when the optional Data overwrite security unit is installed.

Erase All Memory

Select to delete all data inside the memory. When deleting memory, specify the overwrite times.

- EraseNo.

Between 1 to 9

Note

- This setting appears only when the optional Data overwrite security unit is installed.

Transfer Log Setting

You can select whether or not to send log information to the log collection server.

Default: [Off]

- On (Only available from the log collection server.)
- Off

Machine Data Encryption

Encrypt data stored on the hard disk. Once you encrypt the data, the following menus appear on the control panel display.

- Update Encryption Key
Update the encryption key.
- Cancel Encryption
Cancel the encryption settings.
- Print Encryption Key
Print the encryption key.

Note

- This setting appears only when the optional HDD encryption unit is installed.

Changing the Security Options Menu

Follow the procedure below to erase data inside memory.

Important

- This setting appears only when the optional Data overwrite security unit is installed.

1. Press the [Menu] key.

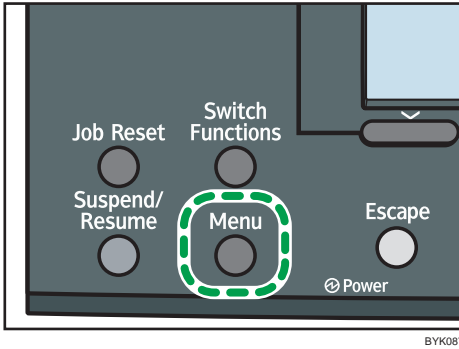

The menu screen appears.

2. Press the [▼] or [▲] key to select [Security Options], and then press the [OK] key.
3. Press the [▼] or [▲] key to select [Extended Security], and then press the [OK] key.
4. Press the [▼] or [▲] key to select [Erase All Memory], and then press the [OK] key.
5. Press the [▼] or [▲] key to select [On], and then press [EraseNo.].
6. Press the [▼] or [▲] key to enter overwrite times, and then press the [OK] key.
7. Press the [▼] or [▲] key to select [On], and then press the [OK] key.

Wait for one second. The [Security Options] menu appears.

8. Press the [Menu] key.

The initial screen appears.

Host Interface Menu

You can set configurations about network connections and communication when using parallel connection between the printer and the computer. The changed configuration holds even if the printer is turned off.

Host Interface Menu Parameters

This section explains parameters that can be set on the host interface menu.

I/O Buffer

Select the size of I/O Buffer. Normally it is not necessary to change this setting.

Default: [128 KB]

- 128 KB
- 256 KB

I/O Timeout

Specify how many seconds the printer should wait before ending a print job. If printing operation is frequently interrupted by data from other ports, you can increase the timeout period.

Default: [15 seconds]

- 10 seconds
- 15 seconds
- 20 seconds
- 25 seconds
- 60 seconds

Network

You can make network-related settings.

Machine IPv4 Address

Select whether to set the IPv4 address automatically or manually.

- Auto-Obtain (DHCP)/Specify (Default: [Auto-Obtain (DHCP)])

When DHCP is set to on, the IPv4 address, subnet mask address, and gateway address cannot be changed. To change them, set DHCP to off. Contact your administrator for information about the network configuration.

- IP Add.

Manually specify the IPv4 address.

Default: 11.22. 33.44

- Subnet M

Manually specify the subnet mask.

Default: **0.0.0.0**

- Gateway

Manually specify the gateway address.

Default: **0.0.0.0**

IPv6 Stateless Setting

Select whether to enable or disable IPv6.

Default: [**Active**]

- Active
- Inactive

IPsec

This is a security function. For details, contact your administrator.

Default: [**Inactive**]

- Active
- Inactive

NW Frame Type

Specify the frame type for NetWare.

Default: [**Auto Select**]

- Auto Select
- Ethernet II
- Ethernet 802.2
- Ethernet 802.3
- Ethernet SNAP

Effective Protocol

Specify the effective protocol.

- IPv4

Default: [**Active**]

- Active
- Inactive

- IPv6

Default: [**Inactive**]

- Active
- Inactive

- NetWare
Default: [**Inactive**]
 - Active
 - Inactive
- SMB
Default: [**Active**]
 - Active
 - Inactive
- AppleTalk
Default: [**Inactive**]
 - Active
 - Inactive

Ethernet Speed

Specify the network speed to operate the printer.

Default: [**Auto Select**]

- Auto Select
- 10Mbps Half Duplex
- 10Mbps Full Duplex
- 100Mbps Half Duplex
- 100Mbps Full Duplex

IEEE802.1X Auth.(Ethernet)

Specify IEEE 802.1X Ethernet authentication.

Default: [**Inactive**]

- Active
- Inactive

Note

- For details about IEEE 802.1X authentication, see "Configuration", Hardware Guide.

Restr.IEEE802.1X Auth.Def.

Restore the default IEEE 802.1X setting.

LAN Type

Select Ethernet or Wireless LAN.

Default: [**Ethernet**]

- Ethernet

- Wireless LAN

Note

- This menu appears only when the optional Wireless LAN interface unit is installed.

Parallel Interface

Specify parallel interface settings. This menu appears when the IEEE 1284 interface board is installed.

Parallel Timing

Specify the parallel interface timing.

Default: [**ACK outside**]

- ACK inside
- ACK outside
- STB down

Parallel Comm. Speed

Specify whether or not to use DMA transfer for receiving data.

Default: [**High Speed**]

- High Speed
- Standard

Selection Signal Status

Specify the selection signal level of the parallel interface.

Default: [**High**]

- High
- Low

Input Prime

You usually do not need to change this setting.

Default: [**Inactive**]

- Active
- Inactive

Bidirectional Comm.

Specify whether to enable or disable bi-directional communication.

Default: [**On**]

- On
- Off

Wireless LAN

Configure settings for Wireless LAN. This menu appears only when the optional Wireless LAN interface unit is installed.

Communication Mode

Specify the transmission mode for Wireless LAN.

Default: [**Infrastructure Mode**]

- 802.11 Ad-hoc Mode
- Infrastructure Mode

SSID Setting

Specify an SSID in infrastructure mode and Ad-hoc Mode.

Default: **blank (SSID)**

- SSID

↓ Note

- Select [?] to enter [/] for the SSID. Also, [\] appears when printing the configuration page, read it as [/].
- Characters used are ASCII 0x20-0x7e (32 bytes).
- An SSID is set automatically to the nearest access point if no SSID has been set.
- If no SSID has been set for Ad-hoc Mode, an SSID is set automatically and the same SSID is used for Ad-hoc Mode and infrastructure mode.
- If blank is specified in SSID for Ad-hoc Mode, "ASSID" appears.
- An SSID can also be set using Web Image Monitor. For details, see Web Image Monitor Help.

Ad-hoc Channel

IEEE 802.11 a/b/g Wireless LAN:

- 2412 - 2472 MHz (1 - 13 channels)
- 5180 - 5320 MHz (36, 40, 44, 48, 52, 56, 60, and 64 channels)

IEEE 802.11 b/g Wireless LAN:

- 2412 - 2462 MHz (1 - 11 channels)

The channel in use might differ depending on the country.

Security Method

Select whether to enable encryption and specify the security type when the encryption is enabled.

Default: [**Off**]

- Off
- WEP

Change (HEX), Change (ASCII)

- WPA

Encryption Method (TKIP, CCMP(AES)), Authentication Method (WPA-PSK, WPA, WPA2-PSK, WPA2)

Note

- WPA appears only when the optional Wireless LAN interface unit is installed.

Wireless LAN Signal

You can check the signal strength when using Wireless LAN.

Note

- This menu appears only when the optional Wireless LAN interface unit is installed.

Restore Defaults

Reset the Wireless LAN to default.

5

USB Settings

Select speed for USB interface.

USB Speed

Default: [Auto Select]

- Auto Select
- Full Speed

Fixed USB Port

Default: [Off]

- Level 1
- Level 2
- Off

Changing the Host Interface Menu

Follow the procedure below to change the I/O Timeout setting.

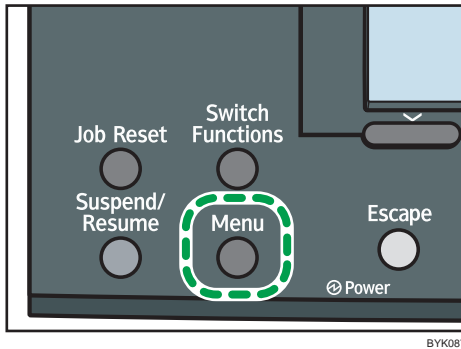
1. Press the [Menu] key.

The menu screen appears.

2. Press the [▼] or [▲] key to select [Host Interface], and then press the [OK] key.
3. Press the [▼] or [▲] key to select [I/O Timeout], and then press the [OK] key.
4. Press the [▼] or [▲] key to select the lead time needed to end a printing operation, and then press the [OK] key.

Wait for one second. The [Host Interface] menu appears.

5. Press the [Menu] key.

The initial screen appears.

Language Menu

You can set a language to be displayed on the menu.

Language Menu Parameters

You can select the language you use. Available languages are as follows:

English, German, French, Italian, Dutch, Swedish, Norwegian, Danish, Spanish, Finnish, Portuguese, Czech, Polish, Hungarian, Russian.

Default: [English]

5

Changing the Language Menu

Follow the procedure below to change the interface language.

1. Press the [Menu] key.

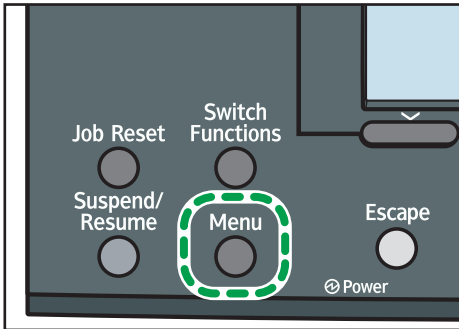

The menu screen appears.

2. Press the [▼] or [▲] key to select [Language], and then press the [OK] key.
3. Press the [▼] or [▲] key to select the language, and then press the [OK] key.
Wait for one second. The [Menu] screen appears.
4. Press the [Menu] key.

The initial screen appears.

Options Menu

Using the options menu, you can configure settings related to form feeding and error logs. This section provides a list of the configurable settings and explains how to check error logs.

Options Menu Parameters

Form Feed

Outputs data that are unprintable, due to errors such as the absence of a line-feed code.

Error Log

If a document cannot be printed due to errors or other reasons, an error log is created. You can check the error log using the control panel.

- All
- Sample Print Jobs
- Locked Print Jobs
- Hold Print Jobs
- Stored Print Jobs

5

Checking the Error Log

If files could not be stored due to printing errors, identify the cause of the errors by checking the error log in the control panel.

★ Important

- The most recent 30 errors are stored in the error log. If a new error is added when there are 30 errors already stored, the oldest error is deleted. However, if the oldest error belongs to one of the following print jobs, it is not deleted. The error is stored separately until the number of those errors reaches 30. You can check any of these print jobs for error log information.
 - Sample Print Jobs
 - Locked Print Jobs
 - Hold Print Jobs
 - Stored Print Jobs
- If the main power switch is turned off, the log is deleted.

1. Press [Option].



2. Select [Error Log] using the [▼] or [▲] key, and then press the [OK] key.

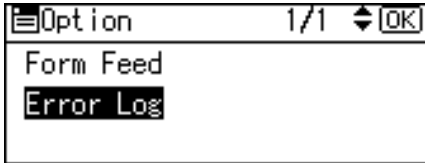

3. Select a type of print jobs using the [▼] or [▲] key, and then press the [OK] key.

If you select [All], all error logs appears.

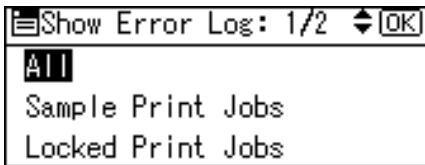

4. Select the error log you want to check using the [▼] or [▲] key.

Press the [Menu] key until the initial screen appears after checking the log.

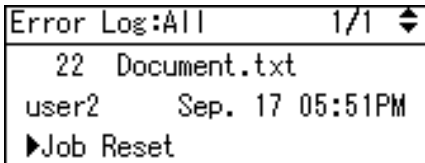

Note

- To print files that appear in the error log, resend them after stored files have been printed or deleted.

6. Monitoring and Configuring the Printer

This chapter explains how to use Web Image Monitor and other applications to monitor the printer or change its settings.

Using Web Image Monitor

Using Web Image Monitor, you can check the printer status and change settings.

Introduction to Web Image Monitor

Available operations

The following operations can be remotely performed using Web Image Monitor from a client computer.

- Displaying printer status or settings
- Checking the print job status or history
- Interrupting currently printing jobs
- Resetting the printer
- Managing the Address Book
- Making printer settings
- Making network protocol settings
- Making security settings

Configuring the printer

To perform the operations from Web Image Monitor, TCP/IP is required. After the printer is configured to use TCP/IP, operations from Web Image Monitor become available.

Recommended Web browser

- Windows:
 - Internet Explorer 5.5 SP2 or higher
 - Firefox 1.0 or higher
- Mac OS:
 - Firefox 1.0 or higher
 - Safari 1.0, 1.2, 2.0 (412.2), or higher

Web Image Monitor supports screen reader software. We recommend JAWS 7.0 or a later version.

Note

- Web Image Monitor does not support Safari running under Mac OS X 10.4.1.
- Display and operation problems can occur if you do not enable JavaScript and cookies, or if you are using a non-recommended Web Browser.
- If you are using a proxy server, change the Web browser settings. Contact your administrator for information about the settings.
- If you click your browser's back button but the previous page does not appear, click the browser's refresh button and try again.
- Printer information is not automatically updated. To perform an update, click [Refresh] in the display area.
- We recommend using Web Image Monitor in the same network.
- If the printer is firewall-protected, it cannot be accessed from computers outside the firewall.
- When using the printer under DHCP, the IP address may be automatically changed by the DHCP server settings. Enable DDNS setting on the printer, and then connect using the printer's host name. Alternatively, set a static IP address to the DHCP server.
- If the HTTP port is disabled, connection to the printer using the printer's URL cannot be established. SSL setting must be enabled on this printer. For details, contact your administrator.
- When using the SSL encryption protocol, enter "https://(printer's IP address)/".
- When you are using Firefox, fonts and colors may be different, or tables may be out of shape.
- When using a host name under Windows Server 2003/2003 R2/2008 or Windows Vista with IPv6 protocol, perform host name resolution using an external DNS server. The host file cannot be used.
- To use JAWS 7.0 under Web Image Monitor, you must be running Windows OS and Microsoft Internet Explorer 5.5 SP2, or a later version.
- If you are using Internet Explorer 8, downloading will be slower than with other browsers. To download faster with Internet Explorer 8, open the browser's [Internet Options] menu and register the machine's URL as a trusted site. Then disable SmartScreen filter for trusted sites. For details about these settings, see the Internet Explorer 8 Help files.
- The process of opening Web Image Monitor can be simplified by adding the URL of Web Image Monitor to the bookmarks of your Web browser. When adding a bookmark, do so in the top page before logging in to Web Image Monitor. If the bookmark is added after the user has logged in the top page, it may not display correctly.

Displaying Top Page

This section explains the Top Page and how to display Web Image Monitor.

★ Important

- When entering an IPv4 address, do not begin segments with zeros. For example: If the address is "192.168.001.010", you must enter it as "192.168.1.10".

1. Start your Web browser.
2. Enter "http://(printer's IP address or host name)/" in your Web browser's URL bar.

Top Page of Web Image Monitor appears.

If the printer's host name has been registered on the DNS or WINS server, you can enter it.

When setting SSL, a protocol for encrypted communication, under environment which server authentication is issued, enter "https://(printer's IP address or host name)/".

Every Web Image Monitor page is divided into the following areas:

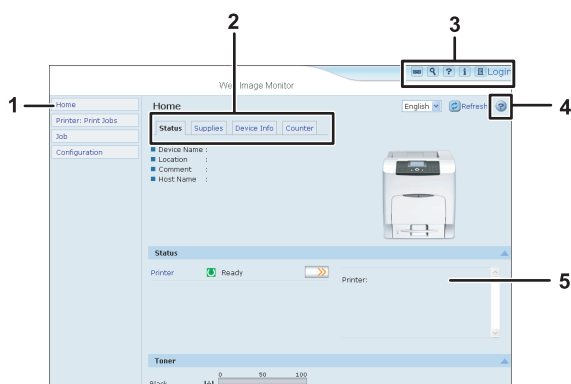

BYK502

1. Menu area

If you select menu, its content will be shown on the work area, or the sub area.

2. Tab area

Details about each menu appear.

3. Header area

The dialog box for switching to the user mode and administrator mode appears, and each mode's menu will be displayed.

The link to help and dialog box for keyword search appears.

4. Help

Use Help to view or download Help file contents.

5. Display area

Displays the contents of the item selected in the menu area.

Printer information in the display area is not automatically updated. Click [Refresh] at the upper right in the display area to update the printer information. Click the Web browser's [Refresh] button to refresh the entire browser screen.

Note

- When using a host name under Windows Server 2003/2003 R2/2008 or Windows Vista with IPv6 protocol, perform host name resolution using an external DNS server. The host file cannot be used.

When User Authentication is Set

For details about logging in to and out of Web Image Monitor, see "If User Authentication is Specified".

Reference

- p.23 "If User Authentication is Specified"

About Menu and Mode

There are two modes available with Web Image Monitor: guest mode and administrator mode.

Displayed Items may differ depending on the printer type.

Guest mode

In the guest mode, printer status, settings, and print job status can be viewed, but the printer settings cannot be changed.

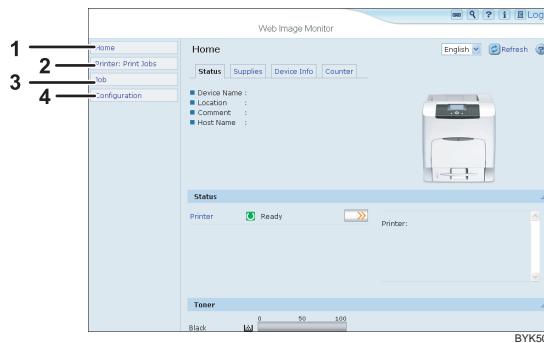

1. Home

The [Status], [Supplies], [Device Info], and [Counter] tab are displayed. Details of the tab menu are displayed on the work area.

2. Printer: Print Jobs

Allows you to display a list of Sample Print, Locked Print, Hold Print, and Stored Print jobs.

3. Job

Display all print files.

4. Configuration

Display current printer and network settings.

Administrator mode

In the administrator mode, you can configure various printer settings.

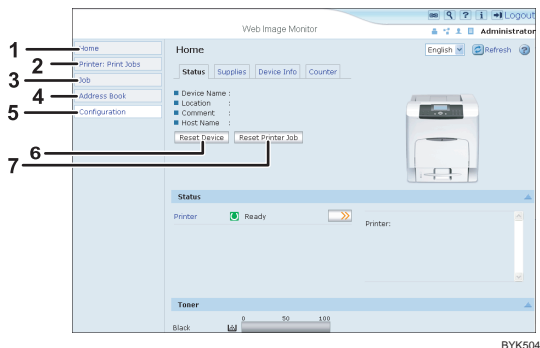

1. Home

The [Status], [Supplies], [Device Info], and [Counter] tab are displayed. Details of the tab menu are displayed on the work area.

2. Printer: Print Jobs

Allows you to display a list of Sample Print, Locked Print, Hold Print, and Stored Print jobs.

3. Job

Display all print files.

4. Address Book

User information can be registered, displayed, changed, and deleted.

5. Configuration

Make system settings for the printer, interface settings, and security.

6. Reset Device

Click to reset the printer. If a print job is being processed, the printer will be reset after the print job is completed. This button is located on Top Page.

7. Reset Printer Job

Click to reset current print jobs and print jobs in queue. This button is located on Top Page.

↓ Note

- For details about messages and settings, see Web Image Monitor Help.

Access in the Administrator Mode

Follow the procedure below to access Web Image Monitor in the administrator mode.

1. On Header area, click [Login].

The window for entering the login user name and password appears.

2. Enter your login user name and password, and then click [Login].

For details about the login user name and password, consult your network administrator.

Depending on the configuration of your Web browser, the login user name and password might be saved. If you do not want to save them, configure your Web browser's settings so that this information is not saved.

Displaying Web Image Monitor Help

When using Help for the first time, clicking the icon marked "?" () makes the following screen appear, in which you can view Help in two different ways, as shown below:



Viewing Help on our Web site

Downloading Help to your computer.

Downloading and checking Help

You can download Help to your computer. As the Help URL, you can specify the path to the local file to view the Help without connecting to the Internet.

 **Note**

- By clicking "?" () in the header area, the contents of Help appear.
- By clicking "?" () in the display area, the Help icon in the display area, Help for the setting items in the display area appears.

Downloading Help

1. In the [OS] list, select the operating system.
2. In the [Language] list, select the language.
3. Click [Download].
4. Download Help by following the instructions on the screen.
5. Store the downloaded compressed file in a given location, and then decompress the file.

To create a link for the Help button (), save the downloaded Help files on a Web server.

Linking the URL of the downloaded Help

You can link the URL of the help file on a Web server to the "?" button.

1. Log in to Web Image Monitor in administrator mode.
2. In the menu area, click [Configuration].
3. Click [Webpage].

4. In the [Set Help URL Target] box, enter the URL of the help file.

If you saved the help file to "C:\HELP\EN", enter "file://C:/HELP/". For example, if you saved the file to a Web server, and the URL of the index file is "http:// a.b.c.d/HELP/EN/index.html", enter "http://a.b.c.d/HELP/".

5. Click [OK].**↓ Note**

- If you save the Help files on your hard disk, you must access them directly - you cannot link to them using the Help button (??).

Registering Classification Codes

This section explains classification codes.

If you register classification codes, the printer logs the number of prints made under each code.

You can register classification codes to individual users and specified purposes, enabling you to monitor printer usage by each.

For example, you can manage accounts according to individual clients or account titles.

Classification Code - Based Process (example)

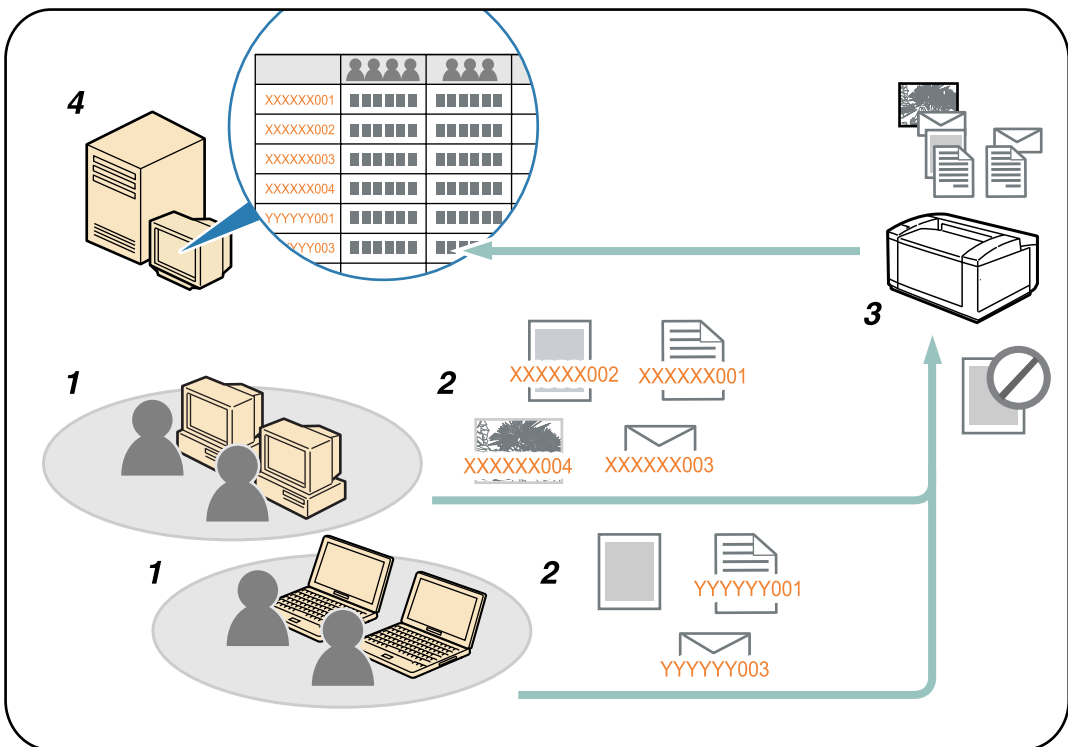

BVNS11

1. Divisions, sections, departments, project teams, users, etc., to be managed.
2. The appropriate classification code for the print job is entered.
3. The job is printed.

When printing in an environment where classification codes are required, print jobs that do not have a classification code cannot be printed.

For details, see "Configuring Classification Codes".

4. Classification codes are collected and managed by an external log collection system.

Configuring Classification Codes

Use Web Image Monitor to specify whether or not to apply classification code requirement to print jobs.

★ Important

- The configuration page can be printed at any time.
- The default setting for classification code requirement is "Optional".

1. Start Web Image Monitor.

2. Click [Login].

A dialog box for entering the login user name and password appears.

3. Enter the login user name and password, and then click [Login].

For details about the login name and password, consult your network administrator.

4. Click [Configuration] in the left area, and then click [Logs].

5. Check that [Required] or [Optional] is selected for [Classification Code] in the [Common Settings for All Logs] column.

If "Required" is selected for the classification code requirement setting in Web Image Monitor, any print job without a classification code specified will not be printed.

6. Click [OK].

7. Click [Logout].

8. Quit Web Image Monitor.

Address Book Backup and Restore

Using Web Image Monitor, you can save or restore the printer's address book data.

Backing Up Address Book Data

Follow the procedure below to save a copy of the printer's address book data.

1. Log in to Web Image Monitor in administrator mode.

For details about logging in, see "Monitoring and Configuring the Printer".

2. Click [Address Book].

3. Click [Maintenance].

4. Enter the encryption key and click [Backup].

Enter the encryption key that was set when the address book was encrypted. For details, contact your administrator.

6

 **Reference**

- p.155 "Monitoring and Configuring the Printer"

Restoring Address Book Data

Follow the procedure below to restore previously saved address book data to the printer.

1. Log in to Web Image Monitor in administrator mode.

For details about logging in, see "Monitoring and Configuring the Printer".

2. Click [Address Book].

3. Click [Maintenance].

4. Click [Restore].

5. Select the file to be restored by following the on-screen instructions.

6. Click [OK].

Restoration of the address data begins.

7. Confirm the message, and then click [OK].

8. Click [Back].

9. Click [Logout].

 **Note**

- The backup will overwrite any address data currently on the printer. The backup will also reset all user counters.

- For details about restoring the address book data, see Web Image Monitor Help.

 **Reference**

- p.155 "Monitoring and Configuring the Printer"

Using SmartDeviceMonitor for Admin

Using SmartDeviceMonitor for Admin, you can monitor and manage multiple devices connected to the network. Use of this software is recommended for administrators only.

You can download SmartDeviceMonitor for Admin from the manufacturer's Web site.

For details about SmartDeviceMonitor for Admin, see the manual supplied with the software.

When Using IPP with SmartDeviceMonitor for Client

When using IPP with SmartDeviceMonitor for Client, note the following:

To use this function, you must first download SmartDeviceMonitor for Client from the manufacturer's Web site and install it on your computer. Contact your local dealer for information on downloading SmartDeviceMonitor for Client.

- The network printer can only receive one print job from SmartDeviceMonitor for Client at a time. While the network printer is printing, another user cannot access it until the job is finished. In this case, SmartDeviceMonitor for Client tries to access the network printer until the retry interval expires.
- If SmartDeviceMonitor for Client cannot access the network printer and times out, it will stop sending the print job. In this case, you should cancel the paused status from the print queue window. SmartDeviceMonitor for Client will resume access to the network printer. You can delete the print job from the print queue window, but canceling a print job printed by the network printer might cause the next job sent from another user to be incorrectly printed.
- If a print job sent from SmartDeviceMonitor for Client is interrupted and the network printer cancels the job because something went wrong, send the print job again.
- Print jobs sent from another computer do not appear in the print queue window, regardless of protocol.
- If various users send print jobs using SmartDeviceMonitor for Client to network printers, the printing order might not be the same as that in which the jobs were sent.
- An IP address cannot be used for the IPP port name because the IP address is used for the SmartDeviceMonitor for Client port name.
- When setting SSL, a protocol for encrypted communication, under the environment where the device certificate is installed, enter "https://(printer's IP address)/". Internet Explorer must be installed on your computer. Use the highest version. Internet Explorer 6.0 or higher is recommended.
- If the [Security Alert] dialog box appears when accessing the printer using IPP to create or configure an IPP port, or when printing, install the certificate. To select the certificate store location when using Certificate Import Wizard, click [Place all certificates in the following store], and then click [Local Computer] under [Trusted Root Certification Authorities].

Note

- For details about SSL settings, consult your network administrator.

Printer Status Notification by E-Mail

Whenever a paper tray becomes empty or paper jams, a notification e-mail is sent to the registered addresses.

You can make the timing and content settings for notification e-mail.

★ Important

- **Depending on your e-mail application, a phishing warning might appear after you receive an e-mail message. To prevent phishing warnings appearing after you receive e-mail from a specified sender, you must add the sender to your e-mail application's exclusion list. For details about how to do this, see your e-mail application's Help.**

The information that can be notified by auto e-mail notification is as follows:

- Call Service
- Out of Toner
- Toner Almost Empty
- Paper Misfeed
- Cover Open
- Out of Paper
- Almost Out of Paper
- Paper Tray Error
- Output Tray Full
- Unit Connection Error
- Duplex Unit Error
- Waste Toner Bottle is Full
- Waste Toner Bottle is Almost Full
- File Storage Memory Full Soon
- Device Access Violation
- Replacement Required: Unit
- Replacement Required Soon: Unit
- Toner Almost Empty (Remaining Level Selectable)

1. Open a Web browser, and then enter "http://{printer's IP address}/" in the address bar.

Top Page of Web Image Monitor appears.

When setting SSL, a protocol for encrypted communication, under environment which server authentication is issued, enter "https://{printer's IP address}/".

2. Click [Login] on Header area of Web Image Monitor.

The window for entering the login user name and password appears.

3. Enter the user name and password, and then click [Login].

For details about the login name and password, consult your network administrator.

4. In the menu area, click [Configuration].**5. On the [Device Settings] area, click [E-mail].****6. Make the following settings:**

- Items in the Reception column: Make the necessary settings for sending and receiving e-mail.
- Items in the SMTP column: Configure the SMTP server. Check your mailing environment, and then specify the necessary items. You can also perform mail authentication for the SMTP server.
- Items in the POP before SMTP column: Configure the POP server. Check your mailing environment, and then specify the necessary items. You can also perform mail authentication for the POP server.
- Items in the POP3/IMAP4 column: Configure the POP3 or IMAP4 server. Check your mailing environment, and then specify the necessary items.
- Items in the E-mail Communication Port column: Configure the port to be used for access to the mail server.
- Items in the E-Mail Notification Account column: Specify these items if you want to use on-demand e-mail notification.

7. Click [OK].

Auto E-mail Notification

1. Click [Configuration] in the menu area, and then click [Auto E-mail Notification] on the [Device Settings] area.

The dialog box for making notification settings appears.

2. Make the following settings:

- Items in Notification Message column: You can set this according to your needs, for example, the printer's location, service representative contact information.
- Items in the Groups to Notify column: E-mail notification addresses can be grouped as required.
- Items in the Select Groups/Items to Notify column: Select groups for each notification type, such as printer status and error.

To make detailed settings for these items, click [Edit] next to [Detailed Settings of Each Item].

3. Click [OK].**4. Click [Logout].****5. Quit Web Image Monitor.**

On-demand E-mail Notification

1. Click **[Configuration]** in the menu area, and then click **[On-demand E-mail Notification]** on the **[Device Settings]** area.

The dialog box for making notification settings appears.

2. **Make the following settings:**

- **Notification Subject:** Enter a text string to be added to the subject line of return e-mails.
- **Items in Notification Message column:** You can set this according to your needs, for example, the printer's location, service representative contact information.
- **Items in the Access Restriction to Information column:** Select whether to restrict accesses based on a specific category of information.
- **Items in the Receivable E-mail Address/Domain Name Settings column:** Enter an e-mail address or domain name to use for requesting information by e-mail and to receive its return e-mail.

3. Click **[OK]**.

4. Click **[Logout]**.

5. **Quit Web Image Monitor.**

6

Mail Authentication

You can configure mail authentication to prevent illegal use of the mail server.

SMTP authentication

Specify SMTP authentication.

When mail is sent to the SMTP server, authentication is performed using SMTP AUTH protocol by prompting the mail originator to enter the user name and password. This prevents illegal use of the SMTP server.

1. Click **[Configuration]** in the menu area, and then click **[E-mail]** on the **[Device Settings]** area.
2. **Make the following settings:**
 - **SMTP Sever Name.**
 - **SNTP Prot No.**
 - **SMTP Authentication:** Enable or disable SMTP authentication.
 - **SMTP Auth. E-mail Address:** Enter the e-mail address.
 - **SMTP Auth. User Name:** Enter the SMTP account name.
 - **SMTP Auth. Password:** To set or change the password for SMTP AUTH.
 - **SMTP Auth. Encryption:** Select whether to encrypt the password or not.

[Auto Select]: Select this setting when PLAIN, LOGIN, CRAM-MD5, or DIGEST-MD5 is specified as the authentication method.

[Active]: Select this setting when CRAM-MD5 or DIGEST-MD5 is specified as the authentication method.

[Inactive]: Select this setting PLAIN or LOGIN is specified as the authentication method.

3. Click [OK].
4. Click [Logout].
5. Quit Web Image Monitor.

POP before SMTP authentication

Select whether to log in to the POP3 server before sending e-mail.

1. Click [Configuration] in the menu area, and then click [E-mail] on the [Device Settings] area.
2. Make the following settings:
 - POP before SMTP: Enable or disable POP before SMTP.
 - POP E-mail Address: Enter the e-mail address.
 - POP User Name: Enter the POP account name.
 - POP Password: To set or change the POP password.
 - Timeout setting after POP Auth.: Enter the time available before connecting to the SMTP server after logging in to the POP server.
3. Click [OK].
4. Click [Logout].
5. Quit Web Image Monitor.

Sending On-demand E-mail

To use on-demand e-mail notification, perform the following configuration tasks in Web Image Monitor.

- 1. Click [Configuration] in the menu area, and then click [E-mail] on the [Device Settings] area.**
- 2. Make the following settings:**
 - E-mail Notification E-mail Address: Enter the address using alphanumeric characters.
 - Receive E-mail Notification: Specify whether to use on-demand e-mail notification.
 - E-mail Notification User Name: Enter the administrator's user name as the mail originator name.
 - E-mail Notification Password: Enter the password of the mail notification user.
- 3. Click [OK].**
- 4. Click [Logout].**
- 5. Quit Web Image Monitor.**

Format of on-demand e-mail messages

To use mail notification, you need to send an on-demand e-mail message to this printer.

Using your mail software, enter the following:

Item	Description
Subject (Referred to as Subject)	Enter a request regarding the device. For details, see the table below.
From (Referred to as From)	Specify a valid mail address. The device information will be sent to the address specified here.

Subject field

Format: `devicestatus?parametername=parameter[&=parameter][&=parameter]...`

Subject field coding examples

Coding example	Action
<code>devicestatus?request=sysconfig&format=text&lang=en</code>	The device's system configuration information will be sent in an English text format.
<code>devicestatus?request=sysconfig</code>	The device's system configuration information will be sent in a preset format and language.

Parameters

Parameter	Meaning	Default
<code>request</code>	Information to be obtained	Mandatory
<code>format</code>	Mail format	Mail will be sent in the format preset for each mail address.
<code>lang</code>	Language for mail body	Mail will be sent in the language preset for each mail address.

Parameters specifying the information to be obtained

Information to be obtained	Parameter
System configuration information	<code>sysconfig</code>

Information to be obtained	Parameter
Network configuration information	netconfig
Printer configuration information	prtconfig
Supplies information	supply
Device status information	status

Parameters specifying the mail format

Mail format	Parameter
Text	text
HTML	html
XML	xml

Parameters specifying the language for mail body

Language for mail body	Parameter
English	en
French	fr
German	de
Italian	it
Spanish	es
Dutch	nl
Danish	da
Finnish	fi
Norwegian	no
Portuguese	pt
Swedish	sv
Czech	cs
Polish	pl

Language for mail body	Parameter
Hungarian	hu

Note

- A mail message must be within 1 MB in size.
- E-mail may be incomplete if sent immediately after power on.
- The Subject field is case-insensitive.
- Parameter names can be written in any order.
- HTML and XML can be selected for subject field, but output is text only.

7. Using a Printer Server

This chapter explains how to configure this printer to work as a network printer.

Preparing Printer Server

This section explains how to configure the printer as a Windows network printer. The printer is configured to enabling network clients to use it. When the network printer is connected via SmartDeviceMonitor for Client, you can set the printing notification function to notify clients of the results of their print jobs.

★ Important

- Under Windows XP Professional or Windows Server 2003/2003 R2, to change printer properties in the [Printer] folder, you need Printer Management access authentication; under Windows Vista or Windows Server 2008, Full Control access authentication. Log on to the file server as an Administrator group.

1. Open the [Printers and Faxes] window from the [Start] menu.

The [Printers and Faxes] window appears.

2. Click the icon of the printer you want to use. On the [File] menu, click [Properties]. The printer properties appear.

3. On the [Sharing] tab, click [Share this printer].

4. To share the printer with users using a different version of Windows, click [Additional Drivers...].

If you have installed an alternative driver by selecting [Share As:] during the printer driver installation, this step can be ignored.

5. On the [Advanced] tab, click the [Printing Defaults...] button. Specify the default values for the printer driver that will be distributed to client computers, and then click [OK].

6. Click [OK], and then close the printer properties.

7

Printing notification via SmartDeviceMonitor for Client

Follow the procedure below to configure the printer to use the printing notification function of SmartDeviceMonitor for Client.

Setting the print server

★ Important

- Under Windows XP Professional or Windows Server 2003/2003 R2, to change printer properties in the [Printer] folder, you need Printer Management access authentication; under Windows Vista or

Windows Server 2008, Full Control access authentication. Log on to the file server as an Administrator group.

1. On the [Start] menu, point to [All Programs], [DeskTopBinder], [SmartDeviceMonitor for Client], and then click [Print Server Setting].

The print server setting dialog box appears.

2. Select the [Notify client PCs of printout/data-transmission] check box, and then click [OK].

After print server setting is made, a dialog box appears. Confirm the dialog box content, and click [OK].

Click [Cancel] to interrupt the procedure.

A dialog box appears for client setting.

3. Click [OK].

The print server setting is completed. Each client must be set to receive print notification.

 **Note**

- Current printing jobs restart from the beginning after the spooler pauses briefly.
- When the expansion function is not used, the function is automatically set as available.
- If you log on using an account that does not have Administrator privileges, the client may not be notified.
- For details, see "Using SmartDeviceMonitor for Client".

 **Reference**

- p.167 "When Using IPP with SmartDeviceMonitor for Client"

Setting a client

1. On the [Start] menu, point to [All Programs], [DeskTopBinder], [SmartDeviceMonitor for Client], and then click [Extended Features Settings].

A dialog box for setting the expansion function appears.

2. Select the [Notify of printout/data-transmission when using print server] check box.

3. Click [OK].

The client setting is completed.

 **Note**

- Set the printing notification function on the printer driver as well as on SmartDeviceMonitor for Client.

Using NetWare

This section describes the setting procedure for network printers in the NetWare environment. In the NetWare environment, you can connect the printer as a "print server" or "remote printer".

★ Important

- IPv6 cannot be used on this function.

Setting procedure

- When using the printer as a print server
 1. Install the network interface board.
 2. Turn the printer off and then back on.
- When using the printer as a remote printer
 1. Install the network interface board.
 2. Configure NetWare.
 3. Start the print server.

↓ Note

- This procedure assumes an environment is already prepared for normal NetWare running the printing service setting.
- The procedure is explained with the following example settings:
 - File server name ...CAREE
 - Print server name ...PSERV
 - Printer name ...R-PRN
 - Queue name ...R-QUEUE

Setting Up as a Print Server (NetWare 3.x)

Follow the procedure below to connect the printer as a print server using NetWare 3.x.

1. Start Web Image Monitor.
2. Click [Login].

A dialog box for entering the login user name and password appears.

3. Enter the login user name and password, and then click [Login].

For details about the login name and password, consult your network administrator.

4. Click [Configuration] in the left area, and then click [NetWare Print Settings].

- Print Server Name: Enter the NetWare print server name. To use the interface board as a print server, enter the name of a print server that is not active on the file server. Use up to 47 characters.

- **Logon Mode:** Specify whether to designate a file server or NDS tree when logging in to NetWare.
- **File Server Name:** When a file server name is entered here, only the specified file server is searched for. This item is mandatory. Use up to 47 characters.
- **NDS Tree:** To enable NDS mode, enter the name of the NDS tree you want to log in to. Use up to 32 alphanumeric characters.
- **NDS Context Name:** To enable NDS mode, enter the print server context. Use up to 127 characters.
- **Operation Mode:** Specify whether to use the interface board as a print server or a remote printer.
- **Remote Printer No.:** This item is effective when the interface board is specified as a remote printer. Enter the same number as the number of the printer to be created on the print server (0 to 254 characters).
- **Job Timeout:** When the interface board is used as a NetWare remote printer, the printer cannot detect when a print job ends. Therefore, the printer terminates printing when a certain period of time has elapsed since it last received print data (i.e., when it has not received print data for a certain period of time). Specify here this period of time (3 to 255 seconds). The initial value is 15 (seconds).
- **Frame Type:** Select the frame type from the drop-down menu.
- **Print Server Protocol:** Select the protocol for NetWare from the drop-down menu.
- **NCP Delivery Protocol:** Select the protocol for NCP delivery.

5. Confirm the settings, and then click [Device Name].

Configuration is now complete. Wait several before restarting Web Image Monitor.

6. Click [Logout].

Note

- To check the configuration is correct, enter the following from the command prompt:
F:> USERLIST
- If the printer works as configured, the name of the print server appears as a connected user.
- If you cannot identify the printer you want to configure, check the printer name against the configuration page printed from the printer. For details about printing a configuration page, see "Test Printing", Quick Installation Guide.
- If no printer names appear in the list, match the frame types of IPX/SPXs for the computer and printer. Use the [Network] dialog box of Windows to change the frame type of the computer.
- For details about Web Image Monitor, see "Using Web Image Monitor".
- For details about the login name and password, consult your network administrator.

Reference

- p.155 "Using Web Image Monitor"

Setting Up as a Print Server (NetWare 4.x, 5 / 5.1, 6 / 6.5)

Follow the procedure below to connect the printer as a print server using NetWare 4.x, NetWare 5 / 5.1, or NetWare 6 / 6.5.

★ Important

- When using the printer as a print server in NetWare 4.x, NetWare 5 / 5.1, or NetWare 6 / 6.5, set it to the NDS mode.
- When using NetWare 5 / 5.1 or NetWare 6 / 6.5, set the printer as a print server.

1. Start Web Image Monitor.

2. Click [Login].

A dialog box for entering the login user name and password appears.

3. Enter the login user name and password, and then click [Login].

For details about the login name and password, consult your network administrator.

4. Click [Configuration] in the left area, and then click [NetWare Print Settings].

5. Confirm the settings, and then click [Device Name].

Configuration is now complete. Wait several minutes before restarting Web Image Monitor.

6. Click [Logout].

7. Quit Web Image Monitor.

↓ Note

- To check the configuration is correct, enter the following from the command prompt:
F:> USERLIST
- If the printer works as configured, the name of the print server appears as a connected user.
- If you cannot identify the printer you want to configure, check the printer name against the configuration page printed from the printer. For details about printing a configuration page, see "Test Printing", Quick Installation Guide.
- If no printer names appear in the list, match the frame types of IPX/SPXs for the computer and printer. Use the [Network] dialog box of Windows to change the frame type of the computer.
- For details about Web Image Monitor, see "Using Web Image Monitor".
- For details about the login name and password, consult your network administrator.

📖 Reference

- p.155 "Using Web Image Monitor"

Using Pure IP in the NetWare 5 / 5.1 or 6 / 6.5 Environment

Follow the procedure below to connect the printer as a print server in a pure IP environment of NetWare 5 / 5.1 or NetWare 6 / 6.5.

★ Important

- When creating a queued print server in a pure IP environment of NetWare 5 / 5.1 or NetWare 6 / 6.5, create a print queue on the file server using NetWare Administrator.
- This printer is not available as a remote printer for use in a pure IP environment.
- To use the printer in a pure IP environment, set it to IPv4.

Setting up using NWadmin

1. From Windows, start NWadmin.

For details about NWadmin, see the NetWare manuals.

2. Select the object in which the print queue is located in the directory tree, and then click [Create] on the [Object] menu.
3. In the [Class of new object] box, click [Print Queue], and then click [OK].
4. In the [Print Queue Name] box, enter the name of the print queue.
5. In the [Print Queue Volume] box, click [Browse].
6. In the [Available objects] box, click the volume in which the print queue is created, and then click [OK].
7. Check the settings, and then click [Create].
8. Select the object in which the printer is located, and then click [Create] on the [Object] menu.
9. In the [Class of new object] box, click [Printer], and then click [OK]. For NetWare 5, click [Printer (Non NDPS)].
10. In the [Printer name] box, enter the printer name.
11. Select the [Define additional properties] check box, and then click [Create].
12. Click [Assignments], and then click [Add] in the [Assignments] area.
13. In the [Available objects] box, click the queue you created, and then click [OK].
14. Click [Configuration], click [Parallel] in the [Printer type] list, and then click [Communication].
15. Click [Manual load] in the [Communication type] area, and then click [OK].
16. Check the settings, and then click [OK].
17. Select a context specified, and then click [Create] on the [Object] menu.
18. In the [Class of new object] box, click [Print Server], and then click [OK]. For NetWare 5, click [Print Server (Non NDPS)].

19. In the [Print Server Name] box, enter the print server name.
20. Select the [Define additional properties] check box, and then click [Create].
21. Click [Assignments], and then click [Add] in the [Assignments] area.
22. In the [Available objects] box, click the queue you created, and then click [OK].
23. Check the settings, and then click [OK].
24. Start the print server by entering the following from the console of the NetWare server.

If the print server is in operation, quit and restart it.

To quit

```
CAREE: unload pserver
```

To start

```
CAREE: load pserver print_server_name
```

Setting up using Web Image Monitor

1. Start Web Image Monitor.

2. Click [Login].

A dialog box for entering the login user name and password appears.

3. Enter the user login user name and password, and then click [Login].

For details about the login name and password, consult your network administrator.

4. Click [Configuration] in the left area, and then click [NetWare Print Settings].

5. Confirm the settings, and then click [Device Name].

Configuration is now complete. Wait several minutes before restarting Web Image Monitor.

6. Click [Logout].

7. Quit Web Image Monitor.

Note

- If you cannot identify the printer you want to configure, check the printer name against the configuration page printed from the printer. For details about printing a configuration page, see "Test Printing", Quick Installation Guide.
- If no printer names appear in the list, match the frame types of IPX/SPXs for the computer and printer. Use the [Network] dialog box of Windows to change the frame type of the computer.
- For details about Web Image Monitor, see "Using Web Image Monitor".
- For details about the login name and password, consult your network administrator.

Reference

- p.155 "Using Web Image Monitor"

Setting Up as a Remote Printer (NetWare 3.x)

Follow the procedure below to use the printer as a remote printer under NetWare 3.x.

Setting up using PCONSOLE

1. Enter "PCONSOLE" from the command prompt.

F:> PCONSOLE

2. Create a print queue.

When using the existing print queue, go to the procedure for creating a printer.

3. From the [Available Options] menu, select [Print Queue Information], and then press the [Enter] key.
4. Press [Insert] key, and then enter a print queue name.
5. Press [Esc] key to return to the [Available Options] menu.
6. Set up the network connection to a printer.
7. On the [Available Options] menu, click [Print Server Information], and then press the [Enter] key.
8. To create a new print server, press the [Insert] key, and then enter a print server name.

For a currently defined print server, select a print server in the [Print Server] list.

9. From the [Print Server Information] menu, select [Print Server Configuration].
10. From the [Print Server Configuration] menu, select [Printer Configuration].
11. Select the printer indicated as [Not Installed].
12. To change the printer name, enter a new name.

A name "printer x" is assigned to the printer. The "x" stands for the number of the selected printer.

13. As type, select [Remote Parallel, LPT1].

The IRQ, Buffer size, Starting form, and Queue service mode are automatically configured.

14. Press the [Esc] key, and then click [Yes] on the confirmation message.
15. Press the [Esc] key to return to [Print Server Configuration Menu].
16. Assign print queues to the created printer.
17. From [Print Server Configuration Menu], select [Queues Serviced By Printer].
18. Select the printer created.
19. Press the [Insert] key to select a queue serviced by the printer.

You can select several queues.

20. Follow the instructions on the screen to make other necessary settings.

Following these steps, check that the queues are assigned.

21. Press the [Esc] key until "Exit?" appears, and then select [Yes] to exit PCONSOLE.
22. Start the print server by entering the following from the console of the NetWare server.

If the print server is in operation, quit and restart it.

To quit

CAREE: unload pserver

To start

CAREE: load pserver **print_server_name**

If the printer works as configured, the message "Waiting for job" appears.

Setting up using Web Image Monitor

1. Start Web Image Monitor.

2. Click [Login].

A dialog box for entering the login user name and password appears.

3. Enter the login user name and password, and then click [Login].

For details about the login name and password, consult your network administrator.

4. Click [Configuration] in the left area, and then click [NetWare Print Settings].

5. Confirm the settings, and then click [Device Name].

Configuration is now complete. Wait several minutes before restarting Web Image Monitor.

6. Click [Logout].

7. Quit Web Image Monitor.

Note

- If you cannot identify the printer you want to configure, check the printer name against the configuration page printed from the printer. For details about printing a configuration page, see "Test Printing", Quick Installation Guide.
- If no printer names appear in the list, match the frame types of IPX/SPXs for the computer and printer. Use the [Network] dialog box of Windows to change the frame type of the computer.
- For details about Web Image Monitor, see "Using Web Image Monitor".
- For details about the login name and password, consult your network administrator.

Reference

- p.155 "Using Web Image Monitor"

Setting Up as a Remote Printer (NetWare 4.x, 5 / 5.1, 6 / 6.5)

Follow the procedure below to use the printer as a remote printer under NetWare 4.x, 5 / 5.1 and 6 / 6.5.

★ Important

- To use the printer as a remote printer under NetWare 4.x, 5 / 5.1, 6 / 6.5, set it to NDS mode.
- Do not use the printer as a remote printer when Pure IP is used.

Setting up using NWadmin

1. From Windows, start NWadmin.

For details about NWadmin, see the NetWare manuals.

2. Set up the network connection to a print queue. Select the object in which the print queue is located in the directory tree, and then click [Create] on the [Object] menu.
3. In the [Class of new object] box, click [Print Queue], and then click [OK].
4. In the [Print Queue Name] box, enter the name of the print queue.
5. In the [Print Queue Volume] box, click [Browse].
6. In the [Available objects] box, click the volume in which the print queue is created, and then click [OK].
7. Check the settings, and then click [Create].
8. Set up the network connection to a printer. Select the object in which the printer is located, and then click [Create] on the [Object] menu.
9. In the [Class of new object] box, click [Printer], and then click [OK]. For NetWare 5, click [Printer (Non NDPS)].
10. In the [Printer name] box, enter the printer name.
11. Select the [Define additional properties] check box, and then click [Create].
12. Assign print queues to the created printer. Click [Assignments], and then click [Add] in the [Assignments] area.
13. In the [Available objects] box, click the queue you created, and then click [OK].
14. Click [Configuration], click [Parallel] in the [Printer type] list, and then click [Communication].
15. Click [Manual load] in the [Communication type] area, and then click [OK]. Check the settings, and then click [OK].
16. Set up the network connection to a print server. Select a context specified, and then click [Create] on the [Object] menu.
17. In the [Class of new object] box, click [Print Server], and then click [OK]. For NetWare 5, click [Print Server (Non NDPS)].
18. In the [Print Server Name:] box, enter the print server name.
19. Select the [Define additional properties] check box, and then click [Create].
20. Assign the printer to the created print server. Click [Assignments], and then click [Add] in the [Assignments] area.

21. In the [Available objects] box, click the queue you created, and then click [OK].
22. In the [Printers] area, click the printer you assigned, and then click [Printer Number].
23. Enter the printer number, and then click [OK]. Check the settings, and then click [OK].
24. Start the print server by entering the following from the console of the NetWare server.

If the print server is in operation, quit and restart it.

To exit

```
CAREE: unload pserver
```

To start

```
CAREE: load pserver print_server_name
```

25. Enter the printer server name as the context name, and then press the [Enter] key.
26. Select the printer name on the context menu, and then press the [Enter] key.

Setting up using Web Image Monitor

1. Start Web Image Monitor.

2. Click [Login].

A dialog box for entering the login user name and password appears.

3. Enter the user login name and password, and then click [Login].

For details about the login name and password, consult your network administrator.

4. Click [Configuration] in the left area, and then click [NetWare Print Settings].

5. Confirm the settings, and then click [Device Name].

Configuration is now complete. Wait several minutes before restarting Web Image Monitor.

6. Click [Logout].

7. Quit Web Image Monitor.

Note

- If you cannot identify the printer you want to configure, check the printer name against the configuration page printed from the printer. For details about printing a configuration page, see "Test Printing", Quick Installation Guide.
- If no printer names appear in the list, match the frame types of IPX/SPXs for the computer and printer. Use the [Network] dialog box of Windows to change the frame type of the computer.
- For details about Web Image Monitor, see "Using Web Image Monitor".
- For details about the login name and password, consult your network administrator.

Reference

- p.155 "Using Web Image Monitor"

8. Mac OS Configuration

This chapter explains how to use this printer with PostScript 3.

Using PostScript 3

The following section explains how to use the PostScript 3 printer driver.

For details about installing the PostScript 3 printer driver, see Driver Installation Guide.

Job Type

Use this to select the type of print job.

★ Important

- If you are using a Type 2 model with ELP NX installed, all print jobs for which "Locked Print" is specified are stored in ELP NX when user authentication is not set. Also note that any jobs for which "Locked Print" is not specified will be deleted according to the default setting of ELP NX.
- For details about how to print using ELP NX, see Enhanced Locked Print NX User's Guide.
- For details about the option settings of ELP NX, consult your administrator.

The following shows the tabs or menus where you can select this function.

[Job Type:] on [Job Log] in the print dialog box.

You can select the following items:

Normal Print

Select this for normal printing. The print job starts immediately after the print command is given.

Sample Print

Use this function to print only one set of a multiple print jobs.

The other sets are saved in the printer. The saved job can be printed from the printer's control panel. You can also delete the saved job.

↓ Note

- The user ID can contain up to eight alphanumeric characters (a-z, A-Z, 0-9). The password can contain 4-8 digits.
- Entering a user ID helps you distinguish your print jobs from others.

Locked Print

Use this function to save documents in the printer memory with a password, and then edit and print them as you want.

Note

- The user ID can contain up to eight alphanumeric characters (a-z, A-Z, 0-9). The password can contain 4-8 digits.
- Entering a user ID helps you distinguish your print jobs from others.

Hold Print

Use this function to temporarily hold a file in the printer, and print it from the computer or the printer's control panel later.

Note

- "User ID:" can contain up to eight alphanumeric (a-z, A-Z, 0-9) characters.
- "File Name:" can contain up to 16 alphanumeric (a-z, A-Z, 0-9) characters.
- Entering a user ID helps you distinguish your print jobs from others.

Stored Print

Use this function to store a file in the printer, and then print it from the computer or the printer's control panel later.

Note

- The user ID can contain up to eight alphanumeric characters (a-z, A-Z, 0-9). The password can contain 4-8 digits.
- The File Name can contain up to 16 alphanumeric characters (a-z, A-Z, 0-9).
- You can assign a password to a saved document, but password assignment is not mandatory.
- Entering a user ID helps you distinguish your print jobs from others.

Store and Print

Use this function to print the file at once and also stores the file in the printer.

Note

- The user ID can contain up to eight alphanumeric characters (a-z, A-Z, 0-9). The password can contain 4-8 digits.
- The File Name can contain up to 16 alphanumeric characters (a-z, A-Z, 0-9).
- You can assign a password to a saved document, but password assignment is not mandatory.
- Entering a user ID helps you distinguish your print jobs from others.

Using sample print

Important

- You need Mac OS X v10.2 or higher to use this function.
- This function is available only if the hard disk is installed on the printer.

- The number of pages the printer can save varies depending on the contents of the print images. At most, the printer can save 100 jobs or 9,000 pages for Sample Print, Locked Print, Hold Print, and Stored Print.
- Sample Print files will not appear on the display panel if they have already been executed or deleted using the Web browser before you select [Sample Print] from the control panel.
- Sample Print files printed or deleted using Web Image Monitor after you select [Sample Print] using the control panel will appear on the display panel. However, an error message will appear if you try to print or delete those Sample Print files.
- If the application has a collate option, be sure to disable it before you send a print job. By default, sample print jobs are automatically collated by the printer driver. If the collate option is selected in the application's print dialog box, more prints than intended may be printed.
- Print jobs are not saved on the hard disk in the following cases. You can check the error log for jobs not saved.
 - When there are 100 Sample Print, Locked Print, Hold Print, and Stored Print jobs saved on the hard disk.
 - When the total number of pages saved on the hard disk exceeds 9,000 pages.

Sending a Sample Print file

- 1. In the application, on the [File] menu, click [Print].**

The [Print] dialog box appears.

- 2. Set the number of copies to two or more.**

The sample print job is sent to the printer, and one set is printed.

- 3. In the pop-up menu, click [Job Log].**

- 4. On the [Job Type:] pop-up menu, select [Sample Print].**

- 5. In the [User ID:] box, enter a user ID using up to eight alphanumeric (a-z, A-Z, 0-9) characters.**

The user ID associates the user with his/her jobs.

- 6. Check the printed output to make sure the settings are correct.**

If the settings are correct, perform the following steps to print the remaining sets.

If you want to delete a saved job, see "Sample Print".

Printing a selected Sample Print file

1. Press [Prt.Jobs].



2. Select [Sample Print Jobs] using the [▼] or [▲] key, and then press [Job List].

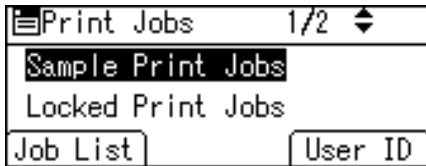

A list of Sample Print files stored in the printer appears.

Depending on the security settings, certain print jobs may not be displayed.

You can print files also by pressing [User ID].

3. Select the file you want to print using the [▼] or [▲] key, and then press [Print].

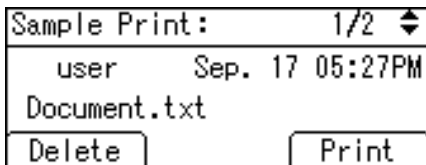

Enter the new number of sets using the scroll keys. You can enter up to 999 sets.

Press the [Escape] key to correct any entry mistakes.

4. Press [Print].

The remaining sets are printed.

To cancel printing, press [Cancel].

↓ Note

- If the set quantity is changed when [User ID] is pressed in step 2, the changed quantity is applied to all selected files.
- When printing is completed, the stored file will be deleted.
- To stop printing after printing has started, press the [Job Reset] key. The file will be deleted.
- For details about [User ID], see "Printing from the User ID Screen".

📖 Reference

- p.68 "Sample Print"
- p.82 "Printing from the User ID Screen"

Deleting a selected Sample Print file

1. Press [Prt.Jobs].



2. Select [Sample Print Jobs] using the [▼] or [▲] key, and then press [Job List].

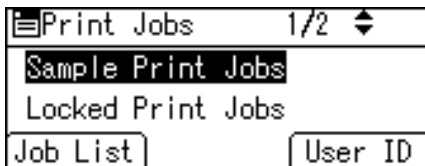

A list of Sample Print files stored in the printer appears.

Depending on the security settings, certain print jobs may not be displayed.

3. Select the file you want to delete using the [▼] or [▲] key, and then press [Delete].

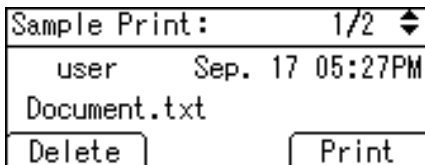

The delete confirmation screen will appear.

4. Press [Delete].

The selected file is deleted.

To cancel printing, press [Cancel].

Using locked print

★ Important

- You need Mac OS X v10.2 or higher to use this function.
- This function is available only if the hard disk is installed on the printer.
- The number of pages the printer can save varies depending on the contents of the print images. At most, the printer can save 100 jobs or 9,000 pages for Sample Print, Locked Print and Hold Print.
- Locked Print files will not appear on the display panel if they have already been printed or deleted using Web Image Monitor before you select [Locked Print] using the control panel.

- Locked Print files printed or deleted using Web Image Monitor after you have selected [Locked Print] using the control panel will still appear on the display panel. However, an error message will appear if you try to print or delete those Locked Print files.
- If the application has a collate option, be sure to disable it before you send a print job. By default, locked print jobs are automatically collated by the printer driver. If the collate option is selected in the application's print dialog box, more prints than intended may be printed.
- Print jobs are not saved on the hard disk in the following cases. You can check the error log for jobs not saved.
 - When there are 100 Sample Print, Locked Print, Hold Print, and Stored Print jobs saved on the hard disk.
 - When the total number of pages saved on the hard disk exceeds 9,000 pages.

Sending a Locked Print file

1. In the application, click [Print] on the [File] menu.

The [Print] dialog box appears.

2. In the pop-up menu, click [Job Log].
3. On the [Job Type:] pop-up menu, click [Locked Print].
4. In the [User ID:] box, enter a user ID using up to eight alphanumeric (a-z, A-Z, 0-9) characters, and then enter a 4-8 digit password in the [Password:] box.

The user ID associates the user with his/her jobs.

5. After making the necessary settings, click [Print].

The document file is saved in the printer.

To print the document, perform the following steps.

For details on deleting the document, see "Locked Print".

Printing a selected Locked Print file

1. Press [Prt.Jobs].



2. Select [Locked Print Jobs] using the [▼] or [▲] key, and then press [Job List].

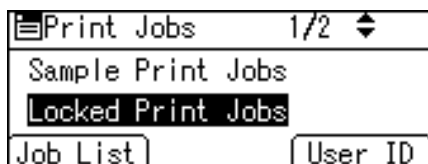

A list of Locked Print files stored in the printer appears.

Depending on the security settings, certain print jobs may not be displayed.

You can print files also by pressing [User ID].

3. Select the file you want to print using the [▼] or [▲] key, and then press [Print].

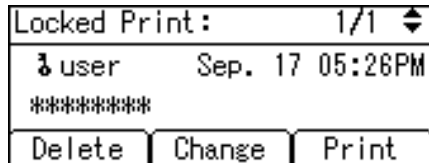

The password screen appears.

4. Enter the password using the number keys, and then press the [OK] key.

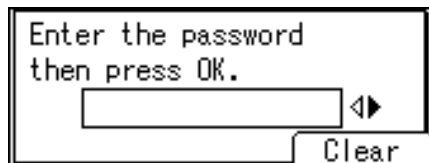

The print confirmation screen appears.

A confirmation screen will appear if the password is not entered correctly. Press [Clear] to enter the password again.

If you forget your password, contact your administrator for help.

5. Press [Print].

The remaining sets are printed.

To cancel printing, press [Cancel].

↓ Note

- When printing is completed, the stored file will be deleted.
- To stop printing after printing has started, press the [Job Reset] key. The file will be deleted.
- For details about [User ID], see "Printing from the User ID Screen".

📖 Reference

- p.71 "Locked Print"
- p.82 "Printing from the User ID Screen"

Deleting a selected Locked Print file

1. Press [Prt.Jobs].



2. Select [Locked Print Jobs] using the [▼] or [▲] key, and then press [Job List].



A list of Locked Print files stored in the printer appears.

Depending on the security settings, certain print jobs may not be displayed.

3. Select the file you want to delete using the [▼] or [▲] key, and then press [Delete].

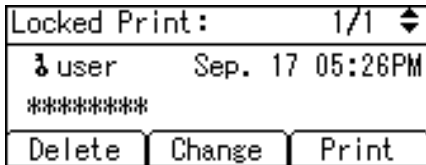

The password screen appears.

4. Enter the password using the number keys, and then press the [OK] key.

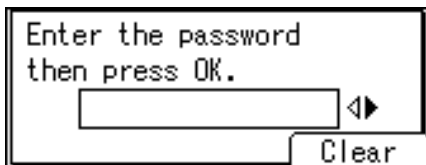

The delete confirmation screen appears.

A confirmation screen will appear if the password is not entered correctly. Press [Clear] to enter the password again.

If you forget your password, contact your administrator for help.

5. Press [Delete].

The selected file is deleted.

To cancel printing, press [Cancel].

Using hold print

★ Important

- You need Mac OS X v10.2 or higher to use this function.
- This function is available only if the hard disk is installed on the printer.
- The number of pages the printer can save varies depending on the contents of the print images. At most, the printer can save 100 jobs or 9,000 pages for Sample Print, Locked Print and Hold Print.
- Hold Print files will not appear on the display panel if they have already been printed or deleted using Web Image Monitor before you select [Hold Print] using the control panel.
- Hold Print files printed or deleted using Web Image Monitor after you have selected [Hold Print] using the control panel will still appear on the display panel. However, an error message will appear if you try to print or delete those Hold Print files.
- If the application has a collate option, be sure to disable it before you send a print job. By default, Hold print jobs are automatically collated by the printer driver. If the collate option is selected in the application's print dialog box, more prints than intended may be printed.
- Print jobs are not saved on the hard disk in the following cases. You can check the error log for jobs not saved.
 - When there are 100 Sample Print, Locked Print, Hold Print, and Stored Print jobs saved on the hard disk.
 - When the total number of pages saved on the hard disk exceeds 9,000 pages.

Sending a Hold Print file

1. In the application, click [Print] on the [File] menu.
The [Print] dialog box appears.
2. In the pop-up menu, click [Job Log].
3. On the [Job Type:] pop-up menu, click [Hold Print].
4. In the [User ID:] box, enter a user ID using up to eight alphanumeric (a-z, A-Z, 0-9) characters. File Name can also be set.
The user ID associates the user with his/her jobs.
5. After making the necessary settings, click [Print].
The document file is saved in the printer.
To print the document, perform the following steps.
For details on deleting the document, see "Hold Print".

Printing a selected Hold Print file

1. Press [Prt.Jobs].



2. Select [Hold Print Jobs] using the [▼] or [▲] key, and then press [Job List].



A list of Hold Print files stored in the printer appears.

Depending on the security settings, certain print jobs may not be displayed.

You can print files also by pressing [User ID].

3. Select the file you want to print using the [▼] or [▲] key, and then press [Print].

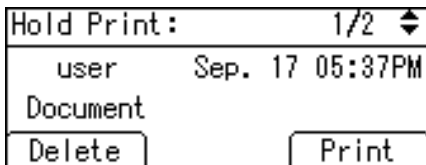

The confirmation screen appears.

4. Press [Print].

The Hold Print file is printed.

To cancel printing, press [Cancel].

Note

- When printing is completed, the stored file will be deleted.
- To stop printing after printing has started, press the [Job Reset] key. The file will be deleted.
- For details about setting printer drivers, see the printer driver Help. You can also print or delete a Hold Print file from Web Image Monitor. For details, see Web Image Monitor Help.
- For details about [User ID], see "Printing from the User ID Screen".

Reference

- p.75 "Hold Print"
- p.82 "Printing from the User ID Screen"

Deleting a selected Hold Print file

1. Press [Prt.Jobs].



2. Select [Hold Print Jobs] using the [▼] or [▲] key, and then press [Job List].



A list of Hold Print files stored in the printer appears.

Depending on the security settings, certain print jobs may not be displayed.

3. Select the file you want to delete using the [▼] or [▲] key, and then press [Delete].

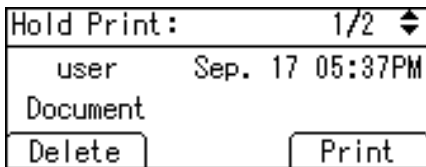

The confirmation screen appears.

4. Press [Delete].

The selected file is deleted.

To cancel printing, press [Cancel].

Using stored print

★ Important

- You need Mac OS X v10.2 or higher to use this function.
- This function is available only if the hard disk is installed on the printer.
- Stored Print files will not appear on the display panel if they have already been printed or deleted using Web Image Monitor before you select [Stored Print] using the control panel.
- Stored Print files printed or deleted using Web Image Monitor after you have selected [Stored Print] using the control panel will still appear on the display panel. However, an error message will appear if you try to print or delete those Stored Print files.

- If the application has a collate option , be sure to disable it before you send a print job. By default, Stored print jobs are automatically collated by the printer driver. If the collate option is selected in the application's print dialog box, more prints than intended may be printed.
- Print jobs are not saved on the hard disk in the following cases. You can check the error log for jobs not saved.
 - When there are 100 Sample Print, Locked Print, Hold Print, and Stored Print jobs saved on the hard disk.
 - When the total number of pages saved on the hard disk exceeds 9,000 pages.

Sending a Stored Print file

1. In the application, click [Print] on the [File] menu.

The [Print] dialog box appears.

2. In the pop-up menu, click [Job Log].

3. On the [Job Type:] pop-up menu, click [Stored Print] or [Store and Print].

- [Stored Print]

Stores the file in the printer and print it later using the control panel.

- [Store and Print]

Prints the file at once and also stores the file in the printer.

4. In the [User ID:] box, enter a user ID using up to eight alphanumeric (a-z, A-Z, 0-9) characters, and then enter a 4-8 digit password in the [Password:] box. File Name can also be set.

The user ID associates the user with his/her jobs.

You can assign a password to a saved document, but password assignment is not mandatory.

The password must be entered when printing or deleting.

5. After making the necessary settings, click [Print].

The document file is saved in the printer.

To print the document, perform the following steps.

For details on deleting the document, see "Stored Print".

Printing a selected Stored Print file

1. Press [Prt.Jobs].



2. Select [Stored Print Jobs] using the [▼] or [▲] key, and then press [Job List].

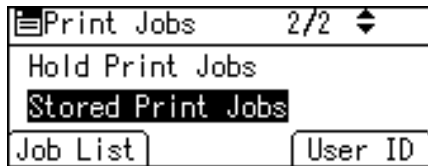

A list of Stored Print files stored in the printer appears.

You can print files also by pressing [User ID].

3. Select the file you want to print using the [▼] or [▲] key, and then press [Print].

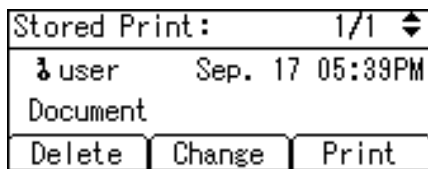

The confirmation screen appears.

If you set a password in the printer driver, a password confirmation screen appears. Enter the password.

If you want to print multiple copies, specify a number of sets in the [Copies:] box.

4. Press [Print].

The Stored Print file is printed.

To cancel printing, press [Cancel].

↓ Note

- When multiple files are selected without setting a quantity, one set less than the minimum number of all settings is applied. If the least number of settings is one set, all selected files will be printed at one set.
- If the number of set quantity is changed when [User ID] is pressed in step 5, the changed quantity is applied to all selected files.
- To stop printing after printing has started, press the [Job Reset] key. A Stored Print file is not deleted even if the [Job Reset] key is pressed.
- Stored Print files sent to the printer are retained until you delete them manually or apply the [Auto Delete Stored Jobs] setting.
- You can set or delete a password after sending files to the printer. Select the file and press [Change] in the Print Job List screen. To set a password, enter the new password. To delete the password, leave the password box blank on entering or confirming the new password, and press the [OK] key.
- For details about the [Auto Delete Stored Jobs], see "Maintenance Menu".
- For details about [User ID], see "Printing from the User ID Screen".

↓ Note

- p.78 "Stored Print"
- p.82 "Printing from the User ID Screen"
- p.110 "Maintenance Menu"

Deleting a selected Stored Print file

1. Press [Prt.Jobs].



2. Select [Stored Print Jobs] using the [▼] or [▲] key, and then press [Job List].



A list of Stored Print files stored in the printer appears.

Depending on the security settings, certain print jobs may not be displayed.

3. Select the file you want to delete using the [▼] or [▲] key, and then press [Delete].

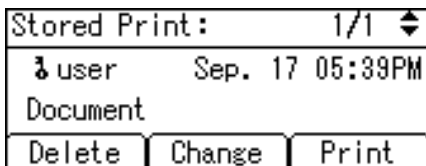

The delete confirmation screen will appear.

If you set the password in the printer driver, enter the password to delete.

If you forget your password, contact your administrator for help.

4. Press [Delete].

The selected file is deleted.

To cancel printing, press [Cancel].

Paper Type

Use this to select the paper type.

The following shows where you can select this function.

[Paper Type:] is displayed under [Set 1] in the [Feature Sets:] list on [Printer Features] in the print dialog box.

Resolution

Use this to set the resolution types.

The following shows where you can select this function.

[Resolution:] is displayed under [Set 1] in the [Feature Sets:] list on [Printer Features] in the print dialog box.

↓ Note

- For more information about the resolution types, see the printer driver Help.

Fit to Paper

When the size of the document and paper size differ, set whether or not to print according to paper size.

The following shows where you can select this function.

[Fit to Paper] is displayed under [Set 1] in the [Feature Sets:] list on [Printer Features] in the print dialog box.

Prompt User

Print is performed with the size of document to be printed unchanged.

Nearest Size and Scale

If the paper size is smaller than the selected paper size, the driver reduces the print size.

If the paper size is larger than the size of document to be printed, print is not to fit the paper size.

Nearest Size and Crop

Print is performed regardless of any differences between selected and actual paper size. However, the print output is not adjusted to fit the paper size.

Economy Color

Use this function to reduce the amount of toner used when printing.

The following shows where you can select this function.

[Economy Color] is displayed under [Set 1] in the [Feature Sets:] list on [Printer Features] in the print dialog box.

Image Smoothing

Use this to select the image smoothing type.

The following shows where you can select this function.

[Image Smoothing] is displayed under [Set 1] in the [Feature Sets:] list on [Printer Features] in the print dialog box.

You can select from the following items:

Off

Disables image smoothing.

On

Performs image smoothing unconditionally.

Auto

Performs image smoothing automatically for images that have a resolution less than 25% of supported printer resolution.

Less than 90 ppi to Less than 300 ppi

Performs image smoothing only when the image has an image resolution (pixels per inch) less than the respective value you have selected in the list.

↓ Note

- When [Auto] is selected, data processing may take a long time.
- When Image Smoothing is used for a mask image, this function may have an undesired effect on the print result.

Color Mode

Use this to select whether the document is printed in color or black and white.

The following shows where you can select this function.

[Color Mode] is displayed under [Set 1] in the [Feature Sets:] list on [Printer Features] in the print dialog box.

You can select from the following items:

Color

Prints color documents in full color.

Black and White

Prints everything, including color documents, in black and white. Black and White printing is faster than Color printing. To stop black and white areas being printed with CMYK toner, select [Black and White] in the printer driver as well as in the application.

Note

- Color images will be printed using CMYK toner, Cyan, Magenta, Yellow, and Black. CMYK are three primary subtractive colors.

Gradation

Use this to select a type of gradation based on your purpose.

The following shows where you can select this function.

[Gradation] is displayed under [Set 1] in the [Feature Sets:] list on [Printer Features] in the print dialog box.

Note

- For details about the gradation types, see the printer driver Help.

Color Setting

Use this to select the correction method used for color conversion.

The following shows where you can select this function.

[Color Setting] is displayed under [Set 2] in the [Feature Sets:] list on [Printer Features] in the print dialog box.

You can select from the following items:

Off

No modification to the color setting.

Fine

Select this setting to perform color matching based on one of the printer's built-in color rendering dictionaries and perform CMYK conversion. This setting performs the printing which output target is Monitor Gamma= 1.8.

Super Fine

Select this setting to use the same color rendering dictionary as in the [Fine] setting but produce output that is more vivid. Use this setting to emphasize light colors. This setting performs the printing which output target is Monitor Gamma= 2.2.

Note

- The color rendering dictionary that is selected in the Color Profile setting is used.
- Use this to select a color rendering dictionary (CRD). The CRD is referred to color matching, so you should select the appropriate CRD for the document you are printing. The selected CRD is also referred to when [Fine] or [Super Fine] is selected for Color Setting. The following items are available: [Auto], [Photographic], [Presentation], and [Solid Color].

Color Profile

Use this to select the color profile pattern.

The following shows where you can select this function.

[Color Profile] is displayed under [Set 2] in the [Feature Sets:] list on [Printer Features] in the print dialog box.

You can select from the following items:

Auto

Use this setting to configure the best color profile pattern automatically depending on the appearance of the document to be printed.

Photographic

Use this setting to enhance the reproduction of photos and graphics that include midtones.

Presentation

Use this setting to enhance the reproduction of documents that contain text and graphics. This CRD is best for printing colored charts, graphs, presentation materials and so on. If you use this CRD for printing photographs, the color or gradations might not be reproduced well.

Solid Color

Use this setting to print specific colors, logos and so on.

User Setting

Use this setting to print images with the CRD downloaded from your application.

CLP Simulation1

Use this setting to print blue color more brightly and vividly.

CLP Simulation2

Use this setting to print blue color more brightly and vividly. Print results are lighter than those of CLP Simulation 1.

↓ Note

- Use this to select a color rendering dictionary (CRD). The CRD is referred to color matching, so you should select the appropriate CRD for the document you are printing. The selected CRD is also referred to when [Fine] or [Super Fine] is selected for [Color Setting]: The following items are available: [Auto], [Photographic], [Presentation], and [Solid Color].

Dithering

Use this to set the Image Rendering mode.

The following shows where you can select this function.

[Dithering] is displayed under [Set 2] in the [Feature Sets:] list on [Printer Features] in the print dialog box.

You can select from the following items:

Auto

Use this setting to configure the best dithering method automatically depending on the appearance of the document to be printed.

Photographic

Performs dithering using an appropriate pattern for photographs.

Text

Performs dithering using an appropriate pattern for text.

User Setting

Use this setting to print images set in halftones in your application.

Gray Reproduction

Use this to select the Black Color mode for text and line art.

The following shows where you can select this function.

[Gray Reproduction (Text/Line Art)] is displayed under [Set 2] in the [Feature Sets:] list on [Printer Features] in the print dialog box.

You can select from the following items:

Black/Gray by K

Prints black using gray.

Black by K

Prints using black toner.

CMY + K

Prints using all toner colors.

Black/Gray by K (Text only)

Prints black text in gray.

Black by K (Text only)

Prints text using black toner.

Black Over Print

Select whether or not to apply a black color over any other colors when printing.

The following shows where you can select this function.

[Black Over Print:] is displayed under [Set 3] in the [Feature Sets:] list on [Printer Features] in the print dialog box.

Separate into CMYK

Use this to select the print separation type.

You can separate the printing data into CMYK to specify a specific color combination.

The following shows where you can select this function.

[Separate into CMYK] is displayed under [Set 3] in the [Feature Sets:] list on [Printer Features] in the print dialog box.

CMYK Simulation Profile

You can simulate the color tone of the printing ink.

You can select the printing ink from US OffsetPrint, Euroscale, JapanColor, and PaletteColor.

The following shows where you can select this function.

[CMYK Simulation Profile] is displayed under [Set 3] in the [Feature Sets:] list on [Printer Features] in the print dialog box.

8

Rotate by 180 degrees

Use this to rotate the print image by 180 degrees.

The following shows where you can select this function.

[Rotate by 180 degrees] is displayed under [Set 3] in the [Feature Sets:] list on [Printer Features] in the print dialog box.

Orientation Override

Use this to set the paper orientation.

The following shows where you can select this function.

[Orientation Override] is displayed under [Set 3] in the [Feature Sets:] list on [Printer Features] in the print dialog box.

You can select from the following items:

- Off
- Landscape
- Portrait

Watermark

Set the Watermark function.

The following shows where you can select this function.

[Watermark:] is displayed under [Set 4] in the [Feature Sets:] list on [Printer Features] in the print dialog box.

Watermark Text

Select the Watermark Text type.

The following shows where you can select this function.

[Watermark Text] is displayed under [Set 4] in the [Feature Sets:] list on [Printer Features] in the print dialog box.

Watermark Font

Select the Watermark Font type.

The following shows where you can select this function.

[Watermark Font] is displayed under [Set 4] in the [Feature Sets:] list on [Printer Features] in the print dialog box.

Watermark Size

Select the Watermark size.

The following shows where you can select this function.

[Watermark Size] is displayed under [Set 4] in the [Feature Sets:] list on [Printer Features] in the print dialog box.

Watermark Angle

Select the Watermark angle.

The following shows where you can select this function.

[Watermark Angle] is displayed under [Set 4] in the [Feature Sets:] list on [Printer Features] in the print dialog box.

Watermark Style

Select the Watermark style.

The following shows where you can select this function.

[Watermark Style] is displayed under [Set 4] in the [Feature Sets:] list on [Printer Features] in the print dialog box.

9. Appendix

When Using Windows Terminal Service/Citrix Presentation Server/Citrix XenApp

The following explains how to use Windows Terminal Service and Maintenance.

Operating Environment

The following operating systems and Citrix Presentation Server/Citrix XenApp versions are supported.

Windows 2000 Server / Advanced Server

- Citrix Presentation Server 4.0

Windows server 2003/2003 R2/2008

- Citrix Presentation Server 4.0
- Citrix XenApp 5.0

Supported Printer Drivers

When Windows Terminal Service is operating

- PCL drivers
- PostScript 3

Limitations

The following limitations apply to the Windows Terminal Service environment.

These limitations are built in Windows Terminal Service or Citrix Presentation Server/Citrix XenApp.

Windows Terminal Service

In the Windows Terminal Service environment, some of the printer driver's functions are unavailable. In an environment where Windows Terminal Service is installed, some of the printer driver's functions are available, even if any function of Windows Terminal Service is not used. When you install SmartDeviceMonitor for Client in an environment where the Terminal Service is running on the Windows 2000 Server family computer, be sure to install it using the install mode. The following are the two methods of installation using the install mode:

1. Use [Add/Remove Programs] in [Control Panel] to install SmartDeviceMonitor for Client.
2. Enter the following command in the MS-DOS command prompt:

CHANGE USER /INSTALL

To quit the install mode, enter the following command in the MS-DOS command prompt.

CHANGE USER /EXECUTE

Citrix Presentation Server/Citrix XenApp [Auto-creating client printers]

Using [Auto-creating client printers] can select a logical printer created by copying the client's local printer data to the MetaFrame server. We strongly recommend testing this function in your network environment before using it for your work.

- The settings for optional equipment will not be stored in the server after the equipment is disconnected. The settings for optional equipment will be restored to its defaults each time the client computer logs on to the server.
- When printing a large number of bitmap images or using the server in a WAN environment over dial-up lines such as ISDN, printing may not be possible or errors may occur, depending on data transfer rates.

Citrix Presentation Server/Citrix XenApp [Printer driver replication]

Using [Printer driver replication] can distribute printer drivers across all servers in a server farm. We strongly recommend testing this function in your network environment before using it for your work.

- If the printer drivers are not properly copied, install them directly onto each server.

Using DHCP

You can use the printer in a DHCP environment. You can also register the printer NetBIOS name on a WINS server when it is running.

- Printers that register the printer NetBIOS name on a WINS server must be configured for the WINS server.
- Supported DHCP servers are Microsoft DHCP Server included with Windows 2000 Server, Windows Server 2003/2003 R2/2008, and the DHCP server included with NetWare and UNIX.
- If you do not use the WINS server, reserve the printer's IP address in the DHCP server so the same IP address is assigned every time.
- To use the WINS server, change the WINS server setting to "active" using the control panel.
- Using the WINS server, you can configure the host name via the remote network printer port.
- DHCP relay-agent is not supported. If you use DHCP relay-agent on a network via ISDN, it will result in increased line charges. This is because your computer connects to the ISDN line whenever a packet is transferred from the printer.
- If there is more than one DHCP server, use the same setting for all servers. The printer operates using data from the DHCP server that responds first.
- DHCP servers can operate in an IPv6 environment, but they cannot be configured to allocate IPv6 addresses or obtain host names.

Using AutoNet

If the printer IPv4 address is not automatically assigned by the DHCP server, a temporary IP address starting with 169.254 and not used on the network can be automatically selected by the printer.

Note

- The IP address assigned by the DHCP server is given priority over that selected by AutoNet.
- You can confirm the current IPv4 address on the configuration page. For more information about the configuration page, see Quick Installation Guide.
- When AutoNet is running, the NetBIOS name is not registered on the WINS server.
- The printer cannot communicate with devices that do not have the AutoNet function. However, this printer can communicate with Macintosh computers running Mac OS X 10.2.3. or higher.

Configuring the WINS Server

The printer can be configured to register its NetBIOS name with a WINS server when the power is turned on. This enables the NetBIOS name of the printer to be specified from Web Image Monitor even in a DHCP environment.

This section explains configuring the WINS server.

Note

- The WINS server is supported with Windows 2000 Servers WINS Manager.
- For details about the WINS server settings, see Windows Help.
- If there is no reply from the WINS server, the NetBIOS name is registered by broadcast.
- The NetBIOS name can be entered using up to 13 alphanumeric characters.

Using Web Image Monitor

1. **Start a Web browser.**
2. **Enter "http://(printer's IP address) /" in the address bar to access the printer whose settings you want to change.**
Top Page of Web Image Monitor appears.
3. **Click [Login].**
The dialog box for entering the user name and password appears.
4. **Enter the user name and password, and then click [Login].**
Contact your administrator for information about the settings.
5. **In the left area, click [Configuration].**
6. **Click [Network] and then click [IPv4].**
7. **Check that [Active] is selected for [WINS] in the [Ethernet + Wireless LAN] column, and then enter the WINS server IPv4 address in [Primary WINS Server] and [Secondary WINS Server].**
8. **Click [OK].**
9. **Quit Web Image Monitor.**

Using telnet

You can also use telnet to configure WINS.

Using the Dynamic DNS Function

Dynamic DNS is a function which dynamically updates (registers and deletes) records (A record, AAAA record, CNAME, and PTR record) managed by the DNS server. When a DNS server is part of the network environment to which this printer, a DNS client, is connected, records can be dynamically updated using this function.

Updating

Updating procedure varies depending on whether the printer IP address is static or acquired by DHCP.

★ Important

- **Dynamic update using message authentication (TSIG, SIG(0)) is not supported.**

For a static IPv4 setting

If the IP address or host name is changed, the A and PTR records are updated. If the A record is registered, CNAME is also registered. CNAMEs that can be registered are as follows:

- Ethernet and Wireless LAN
RNPXXXXXX (XXXXXX represents the last 3 hexadecimal bytes of the MAC address)
However, if CNAME (PRNXXXXXX) overlaps with the host name, CNAME will not be registered.

For DHCPv4 settings

As a substitute for the printer, the DHCP server updates the record, and one of the following occurs:

- When the printer acquires the IP address from the DHCP server, the DHCP server updates the A and PTR records.
- When the printer acquires the IP address from the DHCP server, the printer updates the A record, and the DHCP server updates the PTR record.

If the A record is registered, CNAME is also registered. CNAMEs that can be registered are as follows:

- Ethernet and Wireless LAN
RNPXXXXXX (XXXXXX represents the last 3 hexadecimal bytes of the MAC address)

For IPv6 settings

This printer updates the AAAA record and PTR record.

It also updates CNAME when the AAAA record is updated.

When a stateless address is newly set, it is automatically registered on the DNS server also.

↓ Note

- When the dynamic DNS function is not used, records managed by the DNS server must be updated manually, if the printer's IP address is changed.
- To update the record using the printer, the DNS server has to have one of the following:

- No security settings made.
- If security settings are made, an IP-specified client (this printer) permits updating.

DNS Servers Targeted for Operation

For static IP setting

- Microsoft DNS servers with standard Windows 2000 Server/Windows Server 2003/2003 R2/2008 features
- BIND 8.2.3 or higher

For DHCP setup, when the printer updates the A record

- Microsoft DNS servers with standard Windows 2000 Server/Windows Server 2003/2003 R2/2008 features
- Microsoft DNS servers with standard Windows 2000 Server/Windows Server 2003/2003 R2/2008 features

For DHCP setup, when the DHCP server updates records

- Microsoft DNS servers with standard Windows 2000 Server/Windows Server 2003/2003 R2/2008 features
- BIND 8.2.3 or higher
- DNS servers with standard NetWare 5 (or a higher version) features

For IPv6 setting

- Microsoft DNS servers with standard Windows Server 2003/2003 R2/2008 features
- BIND 9.2.3 or higher

DHCP Servers Targeted for Operation

As a substitute for the printer, DHCP servers capable of updating the A record and PTR record are as follows:

- Microsoft DHCP servers with standard Windows 2000 Server (Service Pack 3 or higher versions)/Windows Server 2003/2003 R2/2008 features
- ISC DHCP 3.0 or higher
- DHCP server with standard NetWare 5 features

Setting the Dynamic DNS Function

Make settings with telnet using the "dns" command.

 **Note**

- For details, see UNIX Supplement.

Precautions

Please pay attention to the following when using the network interface board. When configuration is necessary, follow the appropriate procedures below.

Connecting a Dial-Up Router to a Network

When using NetWare (file server)

If the NetWare file server and printer are on opposite sides of a router, packets are sent back and forth continuously, possibly incurring communications charges. Because packet transmission is a feature of NetWare, you need to change the configuration of the router. If the network you are using does not allow you to configure the router, configure the printer instead.

Configuring the router

Filter packets so they do not pass over the dial-up router.

Configuring the printer with NetWare

1. Following the setup method described earlier in this manual, configure the file server.
2. Set the frame type for NetWare environment.

Configuring the printer without NetWare

1. When not printing, the network interface board sends packets over the network. Set NetWare to "inactive".

Note

- The MAC address of the filtering printer is printed on the printer configuration page. For more information about printing a configuration page, see "Test Printing", Quick Installation Guide.
- For more information about configuring the printer if the router cannot be configured, see the following instructions.
- For more information about selecting a frame type, see "Ethernet Configuration", Hardware Guide.
- For more information about selecting a protocol, see "Ethernet Configuration", Hardware Guide.

When the Wireless LAN Interface Unit Is Installed

When using the Wireless LAN interface on the network, note the following:

If the network area provides poor radio environment

Where radio wave conditions are bad, the network may not function due to interrupted or failed connections. When checking the Wireless LAN signal and the access point, follow the procedure below to improve the situation:

- Position the access point nearer to the printer.
- Clear the space between access point and printer of obstructions.
- Move radio wave generating appliances, such as microwaves, away from the printer and access point.

Note

- For information about how to check radio wave status, see "Wireless LAN Configuration", Hardware Guide.
- For more information about access point radio wave conditions, refer to the access point manual.

Copyright Information about Installed Applications

expat

Copyright (c) 1998, 1999, 2000 Thai Open Source Software Centre, Ltd. and Clark Cooper.

Copyright (c) 2001, 2002 Expat maintainers.

Permission is hereby granted, free of charge, to any person obtaining a copy of this software and associated documentation files (the "Software"), to deal in the Software without restriction, including without limitation the rights to use, copy, modify, merge, publish, distribute, sublicense, and/or sell copies of the Software, and to permit persons to whom the Software is furnished to do so, subject to the following conditions:

The above copyright notice and this permission notice shall be included in all copies or substantial portions of the Software.

THE SOFTWARE IS PROVIDED "AS IS", WITHOUT WARRANTY OF ANY KIND, EXPRESS OR IMPLIED, INCLUDING BUT NOT LIMITED TO THE WARRANTIES OF MERCHANTABILITY, FITNESS FOR A PARTICULAR PURPOSE AND NONINFRINGEMENT. IN NO EVENT SHALL THE AUTHORS OR COPYRIGHT HOLDERS BE LIABLE FOR ANY CLAIM, DAMAGES OR OTHER LIABILITY, WHETHER IN AN ACTION OF CONTRACT, TORT OR OTHERWISE, ARISING FROM, OUT OF OR IN CONNECTION WITH THE SOFTWARE OR THE USE OR OTHER DEALINGS IN THE SOFTWARE.

NetBSD

9

[1] Copyright Notice of NetBSD

For all users to use this product: This product contains NetBSD operating system:

For the most part, the software constituting the NetBSD operating system is not in the public domain; its authors retain their copyright.

The following text shows the copyright notice used for many of the NetBSD source code. For exact copyright notice applicable for each of the files/binaries, the source code tree must be consulted.

A full source code can be found at <http://www.netbsd.org/>.

Copyright (c) 1996-2005 The NetBSD Foundation, Inc.

All rights reserved.

Redistribution and use in source and binary forms, with or without modification, are permitted provided that the following conditions are met:

1. Redistributions of source code must retain the above copyright notice, this list of conditions and the following disclaimer.

2. Redistributions in binary form must reproduce the above copyright notice, this list of conditions and the following disclaimer in the documentation and/or other materials provided with the distribution.
3. All advertising materials mentioning features or use of this software must display the following acknowledgement:
This product includes software developed by the NetBSD Foundation, Inc. and its contributors.
4. Neither the name of The NetBSD Foundation nor the names of its contributors may be used to endorse or promote products derived from this software without specific prior written permission.

THIS SOFTWARE IS PROVIDED BY THE NETBSD FOUNDATION, INC. AND CONTRIBUTORS ``AS IS'' AND ANY EXPRESS OR IMPLIED WARRANTIES, INCLUDING, BUT NOT LIMITED TO, THE IMPLIED WARRANTIES OF MERCHANTABILITY AND FITNESS FOR A PARTICULAR PURPOSE ARE DISCLAIMED. IN NO EVENT SHALL THE FOUNDATION OR CONTRIBUTORS BE LIABLE FOR ANY DIRECT, INDIRECT, INCIDENTAL, SPECIAL, EXEMPLARY, OR CONSEQUENTIAL DAMAGES (INCLUDING, BUT NOT LIMITED TO, PROCUREMENT OF SUBSTITUTE GOODS OR SERVICES; LOSS OF USE, DATA, OR PROFITS; OR BUSINESS INTERRUPTION) HOWEVER CAUSED AND ON ANY THEORY OF LIABILITY, WHETHER IN CONTRACT, STRICT LIABILITY, OR TORT (INCLUDING NEGLIGENCE OR OTHERWISE) ARISING IN ANY WAY OUT OF THE USE OF THIS SOFTWARE, EVEN IF ADVISED OF THE POSSIBILITY OF SUCH DAMAGE

[II] Authors Name List

All product names mentioned herein are trademarks or registered trade-marks of their respective owners.

The following notices are required to satisfy the license terms of the software that we have mentioned in this document:

- This product includes software developed by the University of California, Berkeley and its contributors.
- This product includes software developed by the NetBSD Foundation.
- This product includes software developed by The NetBSD Foundation, Inc. and its contributors.
- This product includes software developed for the NetBSD Project. See <http://www.netbsd.org/> for information about NetBSD.
- This product contains software developed by Ignatios Souvatzis for the NetBSD project.
- This product contains software written by Ignatios Souvatzis and Michael L. Hitch for the NetBSD project.
- This product contains software written by Michael L. Hitch for the NetBSD project.
- This product includes cryptographic software written by Eric Young(eyay@cryptsoft.com)
- This product includes cryptographic software written by Eric Young(eyay@mincom.oz.au)
- This product includes software designed by William Allen Simpson.
- This product includes software developed at Ludd, University of Lulea, Sweden and its contributors.
- This product includes software developed at Ludd, University of Lulea.
- This product includes software developed at the Information Technology Division, US Naval Research Laboratory.

- This product includes software developed by Berkeley Software Design, Inc.
- This product includes software developed by David Jones and Gordon Ross
- This product includes software developed by Gordon W. Ross and Leo Weppelman.
- This product includes software developed by Hellmuth Michaelis and Joerg Wunsch
- This product includes software developed by Internet Research Institute, Inc.
- This product includes software developed by Leo Weppelman and Waldi Ravens.
- This product includes software developed by Mika Kortelainen
- This product includes software developed by Aaron Brown and Harvard University.
- This product includes software developed by Adam Ciarcinski for the NetBSD project.
- This product includes software developed by Adam Glass and Charles M. Hannum.
- This product includes software developed by Adam Glass.
- This product includes software developed by Advanced Risc Machines Ltd.
- This product includes software developed by Alex Zepeda, and Colin Wood for the NetBSD Project.
- This product includes software developed by Alex Zepeda.
- This product includes software developed by Alistair G. Crooks.
- This product includes software developed by Alistair G. Crooks. for the NetBSD project.
- This product includes software developed by Allen Briggs
- This product includes software developed by Amancio Hasty and Roger Hardiman
- This product includes software developed by Berkeley Software Design, Inc.
- This product includes software developed by Berkeley Software Design, Inc.
- This product includes software developed by Bill Paul.
- This product includes software developed by Bodo Moeller. (If available, substitute unlauded o for oe)
- This product includes software developed by Boris Popov.
- This product includes software developed by Brad Pepers
- This product includes software developed by Bradley A. Grantham.
- This product includes software developed by Brini.
- This product includes software developed by Causality Limited.
- This product includes software developed by Charles D. Cranor and Seth Widoff.
- This product includes software developed by Charles D. Cranor and Washington University.
- This product includes software developed by Charles D. Cranor, Washington University, and the University of California, Berkeley and its contributors.
- This product includes software developed by Charles D. Cranor, Washington University, the University of California, Berkeley and its contributors.

- This product includes software developed by Charles D. Cranor.
- This product includes software developed by Charles Hannum.
- This product includes software developed by Charles M. Hannum, by the University of Vermont and State Agricultural College and Garrett A. Wollman, by William F. Jolitz, and by the University of California, Berkeley, Lawrence Berkeley Laboratory, and its contributors.
- This product includes software developed by Charles M. Hannum.
- This product includes software developed by Christian E. Hopps, Ezra Story, Kari Mettinen, Markus Wild, Lutz Vieweg and Michael Teske.
- This product includes software developed by Christian E. Hopps.
- This product includes software developed by Christian Limpach
- This product includes software developed by Christopher G. Demetriou for the NetBSD Project.
- This product includes software developed by Christopher G. Demetriou.
- This product includes software developed by Christos Zoulas.
- This product includes software developed by Chuck Silvers.
- This product includes software developed by Colin Wood for the NetBSD Project.
- This product includes software developed by Colin Wood.
- This product includes software developed by Cybernet Corporation and Nan Yang Computer Services Limited
- This product includes software developed by Daishi Kato
- This product includes software developed by Dale Rahn.
- This product includes software developed by Daniel Widenfalk and Michael L. Hitch.
- This product includes software developed by Daniel Widenfalk for the NetBSD Project.
- This product includes software developed by Darrin B. Jewell
- This product includes software developed by David Miller.
- This product includes software developed by Dean Huxley.
- This product includes software developed by Eduardo Horvath.
- This product includes software developed by Eric S. Hvozda.
- This product includes software developed by Eric S. Raymond
- This product includes software developed by Eric Young (eay@mincom.oz.au)
- This product includes software developed by Eric Young (eay@cryptsoft.com)
- This product includes software developed by Eric Young (eay@mincom.oz.au)
- This product includes software developed by Ezra Story and by Kari Mettinen.
- This product includes software developed by Ezra Story, by Kari Mettinen and by Bernd Ernesti.

- This product includes software developed by Ezra Story, by Kari Mettinen, Michael Teske and by Bernd Ernesti.
- This product includes software developed by Ezra Story, by Kari Mettinen, and Michael Teske.
- This product includes software developed by Ezra Story.
- This product includes software developed by Frank van der Linden for the NetBSD Project.
- This product includes software developed by Gardner Buchanan.
- This product includes software developed by Gary Thomas.
- This product includes software developed by Gordon Ross
- This product includes software developed by Gordon W. Ross
- This product includes software developed by HAYAKAWA Koichi.
- This product includes software developed by Harvard University and its contributors.
- This product includes software developed by Harvard University.
- This product includes software developed by Herb Peyerl.
- This product includes software developed by Hubert Feyrer for the NetBSD Project.
- This product includes software developed by Iain Hibbert
- This product includes software developed by Ian F. Darwin and others.
- This product includes software developed by Ian W. Dall.
- This product includes software developed by Ichiro FUKUHARA.
- This product includes software developed by Ignatios Souvatzis for the NetBSD Project.
- This product includes software developed by Internet Initiative Japan Inc.
- This product includes software developed by James R. Maynard III.
- This product includes software developed by Jared D. McNeill.
- This product includes software developed by Jason L. Wright
- This product includes software developed by Jason R. Thorpe for And Communications, <http://www.and.com/>
- This product includes software developed by Joachim Koenig-Baltes.
- This product includes software developed by Jochen Pohl for The NetBSD Project.
- This product includes software developed by Joerg Wunsch
- This product includes software developed by John Birrell.
- This product includes software developed by John P. Wittkoski.
- This product includes software developed by John Polstra.
- This product includes software developed by Jonathan R. Stone for the NetBSD Project.
- This product includes software developed by Jonathan Stone and Jason R. Thorpe for the NetBSD Project.

- This product includes software developed by Jonathan Stone.
- This product includes software developed by Jukka Marin.
- This product includes software developed by Julian Highfield.
- This product includes software developed by Kazuhisa Shimizu.
- This product includes software developed by Kazuki Sakamoto.
- This product includes software developed by Kenneth Stailey.
- This product includes software developed by Kiyoshi Ikehara.
- This product includes software developed by Klaus Burkert, by Bernd Ernesti, by Michael van Elst, and by the University of California, Berkeley and its contributors.
- This product includes software developed by LAN Media Corporation and its contributors.
- This product includes software developed by Leo Weppelman for the NetBSD Project.
- This product includes software developed by Leo Weppelman.
- This product includes software developed by Lloyd Parkes.
- This product includes software developed by Luke Mewburn.
- This product includes software developed by Lutz Vieweg.
- This product includes software developed by MINOURA Makoto, Takuya Harakawa.
- This product includes software developed by Manuel Bouyer.
- This product includes software developed by Marc Horowitz.
- This product includes software developed by Marcus Comstedt.
- This product includes software developed by Mark Brinicombe for the NetBSD project.
- This product includes software developed by Mark Brinicombe.
- This product includes software developed by Mark Murray
- This product includes software developed by Mark Tinguely and Jim Lowe
- This product includes software developed by Markus Wild.
- This product includes software developed by Martin Husemann and Wolfgang Solfrank.
- This product includes software developed by Masanobu Saitoh.
- This product includes software developed by Masaru Oki.
- This product includes software developed by Mats O Jansson and Charles D.Cranor.
- This product includes software developed by Mats O Jansson.
- This product includes software developed by Matt DeBergalis
- This product includes software developed by Matthew Fredette.
- This product includes software developed by Matthias Pfaller.
- This product includes software developed by Michael Graff for the NetBSD Project.

- This product includes software developed by Michael Graff.
- This product includes software developed by Michael L. Hitch.
- This product includes software developed by Michael Shalayeff.
- This product includes software developed by Michael Smith.
- This product includes software developed by Mike Glover and contributors.
- This product includes software developed by Mike Pritchard.
- This product includes software developed by Minoura Makoto.
- This product includes software developed by Nan Yang Computer Services Limited.
- This product includes software developed by Niels Provos.
- This product includes software developed by Niklas Hallqvist, Brandon Creighton and Job de Haas.
- This product includes software developed by Niklas Hallqvist.
- This product includes software developed by Onno van der Linden.
- This product includes software developed by Paul Kranenburg.
- This product includes software developed by Paul Mackerras.
- This product includes software developed by Per Fogelstrom
- This product includes software developed by Peter Galbavy.
- This product includes software developed by Phase One, Inc.
- This product includes software developed by Philip A. Nelson.
- This product includes software developed by Philip L. Budne.
- This product includes software developed by RiscBSD.
- This product includes software developed by Roar Thronaes.
- This product includes software developed by Rodney W. Grimes.
- This product includes software developed by Roger Hardiman
- This product includes software developed by Roland C. Dowdeswell.
- This product includes software developed by Rolf Grossmann.
- This product includes software developed by Ross Harvey for the NetBSD Project.
- This product includes software developed by Ross Harvey.
- This product includes software developed by Scott Bartram.
- This product includes software developed by Scott Stevens.
- This product includes software developed by Shingo WATANABE.
- This product includes software developed by Softweyr LLC, the University of California, Berkeley, and its contributors.
- This product includes software developed by Soren S. Jorvang.

- This product includes software developed by Stephan Thesing.
- This product includes software developed by Steve Woodford.
- This product includes software developed by Takashi Hamada
- This product includes software developed by Takumi Nakamura.
- This product includes software developed by Tatoku Ogaito for the NetBSD Project.
- This product includes software developed by Terrence R. Lambert.
- This product includes software developed by Tetsuya Isaki.
- This product includes software developed by Thomas Gerner
- This product includes software developed by Thomas Klausner for the NetBSD Project.
- This product includes software developed by Tobias Weingartner.
- This product includes software developed by Todd C. Miller.
- This product includes software developed by Tohru Nishimura and Reinoud Zandijk for the NetBSD Project.
- This product includes software developed by Tohru Nishimura for the NetBSD Project.
- This product includes software developed by Tohru Nishimura. for the NetBSD Project.
- This product includes software developed by Tools GmbH.
- This product includes software developed by Toru Nishimura.
- This product includes software developed by Trimble Navigation, Ltd.
- This product includes software developed by WIDE Project and its contributors.
- This product includes software developed by Waldi Ravens.
- This product includes software developed by Wasabi Systems for Zembu Labs, Inc. <http://www.zembu.com/>
- This product includes software developed by Winning Strategies, Inc.
- This product includes software developed by Wolfgang Solfrank.
- This product includes software developed by Yasushi Yamasaki
- This product includes software developed by Zembu Labs, Inc.
- This product includes software developed by the Alice Group.
- This product includes software developed by the Center for Software Science at the University of Utah.
- This product includes software developed by the Charles D. Cranor, Washington University, University of California, Berkeley and its contributors.
- This product includes software developed by the Computer Systems Engineering Group at Lawrence Berkeley Laboratory.
- This product includes software developed by the David Muir Sharnoff.
- This product includes software developed by the Harvard University and its contributors.

- This product includes software developed by the Kungliga Tekniska Hogskolan and its contributors.
- This product includes software developed by the Network Research Group at Lawrence Berkeley Laboratory.
- This product includes software developed by the OpenSSL Project for use in the OpenSSL Toolkit. (<http://www.OpenSSL.org/>)
- This product includes software developed by the PocketBSD project and its contributors.
- This product includes software developed by the RiscBSD kernel team
- This product includes software developed by the RiscBSD team.
- This product includes software developed by the SMCC Technology Development Group at Sun Microsystems, Inc.
- This product includes software developed by the University of California, Berkeley and its contributors, as well as the Trustees of Columbia University.
- This product includes software developed by the University of California, Lawrence Berkeley Laboratory and its contributors.
- This product includes software developed by the University of California, Lawrence Berkeley Laboratory.
- This product includes software developed by the University of Illinois at Urbana and their contributors.
- This product includes software developed by the University of Vermont and State Agricultural College and Garrett A. Wollman.
- This product includes software developed by the University of Vermont and State Agricultural College and Garrett A. Wollman, by William F. Jolitz, and by the University of California, Berkeley, Lawrence Berkeley Laboratory, and its contributors.
- This product includes software developed for the FreeBSD project
- This product includes software developed for the NetBSD Project by Bernd Ernesti.
- This product includes software developed for the NetBSD Project by Christopher G. Demetriou.
- This product includes software developed for the NetBSD Project by Christos Zoulas
- This product includes software developed for the NetBSD Project by Emmanuel Dreyfus.
- This product includes software developed for the NetBSD Project by Frank van der Linden
- This product includes software developed for the NetBSD Project by Ignatios Souvatzis.
- This product includes software developed for the NetBSD Project by Jason R. Thorpe.
- This product includes software developed for the NetBSD Project by John M. Vinopal.
- This product includes software developed for the NetBSD Project by Matthias Drochner.
- This product includes software developed for the NetBSD Project by Michael L. Hitch.
- This product includes software developed for the NetBSD Project by Perry E. Metzger.
- This product includes software developed for the NetBSD Project by Scott Bartram and Frank van der Linden

- This product includes software developed for the NetBSD Project by Allegro Networks, Inc., and Wasabi Systems, Inc.
- This product includes software developed for the NetBSD Project by Genetec Corporation.
- This product includes software developed for the NetBSD Project by Jonathan Stone.
- This product includes software developed for the NetBSD Project by Piermont Information Systems Inc.
- This product includes software developed for the NetBSD Project by SUNET, Swedish University Computer Network.
- This product includes software developed for the NetBSD Project by Shigeyuki Fukushima.
- This product includes software developed for the NetBSD Project by Wasabi Systems, Inc.
- This product includes software developed under OpenBSD by Per Fogelstrom Opsycon AB for RTMX Inc, North Carolina, USA.
- This product includes software developed under OpenBSD by Per Fogelstrom.
- This software is a component of "386BSD" developed by William F. Jolitz, TeleMuse.
- This software was developed by Holger Veit and Brian Moore for use with "386BSD" and similar operating systems. "Similar operating systems" includes mainly non-profit oriented systems for research and education, including but not restricted to "NetBSD", "FreeBSD", "Mach" (by CMU).
- This software includes software developed by the Computer Systems Laboratory at the University of Utah.
- This product includes software developed by Computing Services at Carnegie Mellon University (<http://www.cmu.edu/computing/>).
- This product includes software developed by Allen Briggs.

In the following statement, "This software" refers to the Mitsumi CD-ROM driver:

- This software was developed by Holger Veit and Brian Moore for use with "386BSD" and similar operating systems. "Similar operating systems" includes mainly non-profit oriented systems for research and education, including but not restricted to "NetBSD", "FreeBSD", "Mach" (by CMU).

In the following statement, "This software" refers to the parallel port driver:

- This software is a component of "386BSD" developed by William F. Jolitz, TeleMuse.

FreeBSD 4.6.2/netipx

Copyright (c) 1984, 1985, 1986, 1987, 1993

The Regents of the University of California. All rights reserved.

Modifications Copyright (c) 1995, Mike Mitchell

Modifications Copyright (c) 1995, John Hay

Sablotron(Version 0.82)

Copyright (c) 2000 Ginger Alliance Ltd. All Rights Reserved

a) The application software installed on this product includes the Sablotron software Version 0.82 (hereinafter, "Sablotron 0.82"), with modifications made by the product manufacturer. The original code of the Sablotron 0.82 is provided by Ginger Alliance Ltd., the initial developer, and the modified code of the Sablotron 0.82 has been derived from such original code provided by Ginger Alliance Ltd.

b) The product manufacturer provides warranty and support to the application software of this product including the Sablotron 0.82 as modified, and the product manufacturer makes Ginger Alliance Ltd., the initial developer of the Sablotron 0.82, free from these obligations.

c) The Sablotron 0.82 and the modifications thereof are made available under the terms of Mozilla Public License Version 1.1 (hereinafter, "MPL 1.1"), and the application software of this product constitutes the "Larger Work" as defined in MPL 1.1. The application software of this product except for the Sablotron 0.82 as modified is licensed by the product manufacturer under separate agreement(s).

d) The source code of the modified code of the Sablotron 0.82 is available at: <http://support-download.com/services/device/sablot/notice082.html>

e) The source code of the Sablotron software is available at: <http://www.gingerall.com>

f) MPL 1.1 is available at: <http://www.mozilla.org/MPL/MPL-1.1.html>

JPEG LIBRARY

- The software installed on this product is based in part on the work of the Independent JPEG Group.

9

SASL

Copyright (c) 2001 Carnegie Mellon University. All rights reserved.

Redistribution and use in source and binary forms, with or without modification, are permitted provided that the following conditions are met:

1. Redistributions of source code must retain the above copyright notice, this list of conditions and the following disclaimer.
2. Redistributions in binary form must reproduce the above copyright notice, this list of conditions and the following disclaimer in the documentation and/or other materials provided with the distribution.
3. The name "Carnegie Mellon University" must not be used to endorse or promote products derived from this software without prior written permission.

For permission or any other legal details, please contact:

Office of Technology Transfer

Carnegie Mellon University

5000 Forbes Avenue
Pittsburgh, PA 15213-3890
(412) 268-4387, fax: (412) 268-7395
tech-transfer@andrew.cmu.edu

4. Redistributions of any form whatsoever must retain the following acknowledgment: "This product includes software developed by Computing Services at Carnegie Mellon University (<http://www.cmu.edu/computing/>)."

CARNEGIE MELLON UNIVERSITY DISCLAIMS ALL WARRANTIES WITH REGARD TO THIS SOFTWARE, INCLUDING ALL IMPLIED WARRANTIES OF MERCHANTABILITY AND FITNESS, IN NO EVENT SHALL CARNEGIE MELLON UNIVERSITY BE LIABLE FOR ANY SPECIAL, INDIRECT OR CONSEQUENTIAL DAMAGES OR ANY DAMAGES WHATSOEVER RESULTING FROM LOSS OF USE, DATA OR PROFITS, WHETHER IN AN ACTION OF CONTRACT, NEGLIGENCE OR OTHER TORTIOUS ACTION, ARISING OUT OF OR IN CONNECTION WITH THE USE OR PERFORMANCE OF THIS SOFTWARE.

RSA BSAFE®



- This product includes RSA BSAFE (c) cryptographic software from RSA Security Inc.
- RSA, BSAFE are either registered trademarks or trademarks of RSA Security Inc. in the United States and/or other countries.
- RSA Security Inc. All rights reserved.

Open SSL

Copyright (c) 1998-2004 The OpenSSL Project. All rights reserved.

Redistribution and use in source and binary forms, with or without modification, are permitted provided that the following conditions are met:

1. Redistributions of source code must retain the above copyright notice, this list of conditions and the following disclaimer.

2. Redistributions in binary form must reproduce the above copyright notice, this list of conditions and the following disclaimer in the documentation and/or other materials provided with the distribution.

3. All advertising materials mentioning features or use of this software must display the following acknowledgment:

"This product includes software developed by the OpenSSL Project for use in the OpenSSL Toolkit. (<http://www.openssl.org/>)"

4. The names "OpenSSL Toolkit" and "OpenSSL Project" must not be used to endorse or promote products derived from this software without prior written permission. For written permission, please contact openssl-core@openssl.org.

5. Products derived from this software may not be called "OpenSSL" nor may "OpenSSL" appear in their names without prior written permission of the OpenSSL Project.

6. Redistributions of any form whatsoever must retain the following acknowledgment:

"This product includes software developed by the OpenSSL Project for use in the OpenSSL Toolkit (<http://www.openssl.org/>)"

THIS SOFTWARE IS PROVIDED BY THE OpenSSL PROJECT "AS IS" AND ANY EXPRESSED OR IMPLIED WARRANTIES, INCLUDING, BUT NOT LIMITED TO, THE IMPLIED WARRANTIES OF MERCHANTABILITY AND FITNESS FOR A PARTICULAR PURPOSE ARE DISCLAIMED. IN NO EVENT SHALL THE OpenSSL PROJECT OR ITS CONTRIBUTORS BE LIABLE FOR ANY DIRECT, INDIRECT, INCIDENTAL, SPECIAL, EXEMPLARY, OR CONSEQUENTIAL DAMAGES (INCLUDING, BUT NOT LIMITED TO, PROCUREMENT OF SUBSTITUTE GOODS OR SERVICES; LOSS OF USE, DATA, OR PROFITS; OR BUSINESS INTERRUPTION) HOWEVER CAUSED AND ON ANY THEORY OF LIABILITY, WHETHER IN CONTRACT, STRICT LIABILITY, OR TORT (INCLUDING NEGLIGENCE OR OTHERWISE) ARISING IN ANY WAY OUT OF THE USE OF THIS SOFTWARE, EVEN IF ADVISED OF THE POSSIBILITY OF SUCH DAMAGE.

9

This product includes cryptographic software written by Eric Young (ey@cryptsoft.com). This product includes software written by Tim Hudson (tjh@cryptsoft.com).

Original SSLey License

Copyright (C) 1995-1998 Eric Young (ey@cryptsoft.com) All rights reserved.

This package is an SSL implementation written by Eric Young (ey@cryptsoft.com).

The implementation was written so as to conform with Netscapes SSL.

This library is free for commercial and non-commercial use as long as the following conditions are adhered to. The following conditions apply to all code found in this distribution, be it the RC4, RSA, lhash, DES, etc., code; not just the SSL code. The SSL documentation included with this distribution is covered by the same copyright terms except that the holder is Tim Hudson (tjh@cryptsoft.com).

Copyright remains Eric Young's, and as such any Copyright notices in the code are not to be removed. If this package is used in a product, Eric Young should be given attribution as the author of the parts of the library used. This can be in the form of a textual message at program startup or in documentation (online or textual) provided with the package.

Redistribution and use in source and binary forms, with or without modification, are permitted provided that the following conditions are met:

1. Redistributions of source code must retain the copyright notice, this list of conditions and the following disclaimer.
2. Redistributions in binary form must reproduce the above copyright notice, this list of conditions and the following disclaimer in the documentation and/or other materials provided with the distribution.
3. All advertising materials mentioning features or use of this software must display the following acknowledgement: "This product includes cryptographic software written by Eric Young (eay@cryptsoft.com)" The word 'cryptographic' can be left out if the routines from the library being used are not cryptographic related :-).
4. If you include any Windows specific code (or a derivative thereof) from the apps directory (application code) you must include an acknowledgement: "This product includes software written by Tim Hudson (tjh@cryptsoft.com)"

THIS SOFTWARE IS PROVIDED BY ERIC YOUNG "AS IS" AND ANY EXPRESS OR IMPLIED WARRANTIES, INCLUDING, BUT NOT LIMITED TO, THE IMPLIED WARRANTIES OF MERCHANTABILITY AND FITNESS FOR A PARTICULAR PURPOSE ARE DISCLAIMED. IN NO EVENT SHALL THE AUTHOR OR CONTRIBUTORS BE LIABLE FOR ANY DIRECT, INDIRECT, INCIDENTAL, SPECIAL, EXEMPLARY, OR CONSEQUENTIAL DAMAGES (INCLUDING, BUT NOT LIMITED TO, PROCUREMENT OF SUBSTITUTE GOODS OR SERVICES; LOSS OF USE, DATA, OR PROFITS; OR BUSINESS INTERRUPTION) HOWEVER CAUSED AND ON ANY THEORY OF LIABILITY, WHETHER IN CONTRACT, STRICT LIABILITY, OR TORT (INCLUDING NEGLIGENCE OR OTHERWISE) ARISING IN ANY WAY OUT OF THE USE OF THIS SOFTWARE, EVEN IF ADVISED OF THE POSSIBILITY OF SUCH DAMAGE.

The licence and distribution terms for any publicly available version or derivative of this code cannot be changed. i.e. this code cannot simply be copied and put under another distribution licence [including the GNU Public Licence.]

Open SSH

The licences which components of this software fall under are as follows. First, we will summarize and say that all components are under a BSD licence, or a licence more free than that.

OpenSSH contains no GPL code.

1)

Copyright (c) 1995 Tatu Ylonen <ylo@cs.hut.fi>, Espoo, Finland All rights reserved

As far as I am concerned, the code I have written for this software can be used freely for any purpose. Any derived versions of this software must be clearly marked as such, and if the derived work is incompatible with the protocol description in the RFC file, it must be called by a name other than "ssh" or "Secure Shell".

[Tatu continues]

However, I am not implying to give any licenses to any patents or copyrights held by third parties, and the software includes parts that are not under my direct control. As far as I know, all included source code is used in accordance with the relevant license agreements and can be used freely for any purpose (the GNU license being the most restrictive); see below for details.

[However, none of that term is relevant at this point in time. All of these restrictively licenced software components which he talks about have been removed from OpenSSH, i.e.,

- RSA is no longer included, found in the OpenSSL library
- IDEA is no longer included, its use is deprecated
- DES is now external, in the OpenSSL library
- GMP is no longer used, and instead we call BN code from OpenSSL
- Zlib is now external, in a library
- The make-ssh-known-hosts script is no longer included
- TSS has been removed
- MD5 is now external, in the OpenSSL library
- RC4 support has been replaced with ARC4 support from OpenSSL
- Blowfish is now external, in the OpenSSL library

[The licence continues]

Note that any information and cryptographic algorithms used in this software are publicly available on the Internet and at any major bookstore, scientific library, and patent office worldwide. More information can be found e.g. at "<http://www.cs.hut.fi/crypto>".

The legal status of this program is some combination of all these permissions and restrictions. Use only at your own responsibility. You will be responsible for any legal consequences yourself; I am not making any claims whether possessing or using this is legal or not in your country, and I am not taking any responsibility on your behalf.

9

NO WARRANTY

BECAUSE THE PROGRAM IS LICENSED FREE OF CHARGE, THERE IS NO WARRANTY FOR THE PROGRAM, TO THE EXTENT PERMITTED BY APPLICABLE LAW. EXCEPT WHEN OTHERWISE STATED IN WRITING THE COPYRIGHT HOLDERS AND/OR OTHER PARTIES PROVIDE THE PROGRAM "AS IS" WITHOUT WARRANTY OF ANY KIND, EITHER EXPRESSED OR IMPLIED, INCLUDING, BUT NOT LIMITED TO, THE IMPLIED WARRANTIES OF MERCHANTABILITY AND FITNESS FOR A PARTICULAR PURPOSE. THE ENTIRE RISK AS TO THE QUALITY AND PERFORMANCE OF THE PROGRAM IS WITH YOU. SHOULD THE PROGRAM PROVE DEFECTIVE, YOU ASSUME THE COST OF ALL NECESSARY SERVICING, REPAIR OR CORRECTION.

IN NO EVENT UNLESS REQUIRED BY APPLICABLE LAW OR AGREED TO IN WRITING WILL ANY COPYRIGHT HOLDER, OR ANY OTHER PARTY WHO MAY MODIFY AND/OR REDISTRIBUTE THE PROGRAM AS PERMITTED ABOVE, BE LIABLE TO YOU FOR DAMAGES, INCLUDING ANY GENERAL, SPECIAL, INCIDENTAL OR CONSEQUENTIAL DAMAGES ARISING OUT OF THE USE OR INABILITY TO USE THE PROGRAM (INCLUDING BUT NOT LIMITED TO LOSS OF DATA OR DATA BEING

RENDERED INACCURATE OR LOSSES SUSTAINED BY YOU OR THIRD PARTIES OR A FAILURE OF THE PROGRAM TO OPERATE WITH ANY OTHER PROGRAMS), EVEN IF SUCH HOLDER OR OTHER PARTY HAS BEEN ADVISED OF THE POSSIBILITY OF SUCH DAMAGES.

2)

The 32-bit CRC compensation attack detector in deattack.c was contributed by CORE SDI S.A. under a BSD-style license.

Cryptographic attack detector for ssh - source code

Copyright (c) 1998 CORE SDI S.A., Buenos Aires, Argentina.

All rights reserved. Redistribution and use in source and binary forms, with or without modification, are permitted provided that this copyright notice is retained.

THIS SOFTWARE IS PROVIDED "AS IS" AND ANY EXPRESS OR IMPLIED WARRANTIES ARE DISCLAIMED. IN NO EVENT SHALL CORE SDI S.A. BE LIABLE FOR ANY DIRECT, INDIRECT, INCIDENTAL, SPECIAL, EXEMPLARY OR CONSEQUENTIAL DAMAGES RESULTING FROM THE USE OR MISUSE OF THIS SOFTWARE.

Ariel Futoransky <futo@core-sdi.com>

<<http://www.core-sdi.com>>

3)

One component of the ssh source code is under a 3-clause BSD license, held by the University of California, since we pulled these parts from original Berkeley code.

Copyright (c) 1983, 1990, 1992, 1993, 1995

The Regents of the University of California. All rights reserved.

Redistribution and use in source and binary forms, with or without modification, are permitted provided that the following conditions are met:

1. Redistributions of source code must retain the above copyright notice, this list of conditions and the following disclaimer.
2. Redistributions in binary form must reproduce the above copyright notice, this list of conditions and the following disclaimer in the documentation and/or other materials provided with the distribution.
3. Neither the name of the University nor the names of its contributors may be used to endorse or promote products derived from this software without specific prior written permission.

THIS SOFTWARE IS PROVIDED BY THE REGENTS AND CONTRIBUTORS "AS IS" AND ANY EXPRESS OR IMPLIED WARRANTIES, INCLUDING, BUT NOT LIMITED TO, THE IMPLIED WARRANTIES OF MERCHANTABILITY AND FITNESS FOR A PARTICULAR PURPOSE ARE DISCLAIMED. IN NO EVENT SHALL THE REGENTS OR CONTRIBUTORS BE LIABLE FOR ANY DIRECT, INDIRECT, INCIDENTAL, SPECIAL, EXEMPLARY, OR CONSEQUENTIAL DAMAGES (INCLUDING, BUT NOT LIMITED TO, PROCUREMENT OF SUBSTITUTE GOODS OR SERVICES; LOSS OF USE, DATA, OR PROFITS; OR BUSINESS INTERRUPTION) HOWEVER CAUSED AND ON ANY THEORY OF LIABILITY, WHETHER IN CONTRACT, STRICT LIABILITY, OR TORT (INCLUDING NEGLIGENCE OR OTHERWISE) ARISING IN

ANY WAY OUT OF THE USE OF THIS SOFTWARE, EVEN IF ADVISED OF THE POSSIBILITY OF SUCH DAMAGE.

4)

Remaining components of the software are provided under a standard 2-term BSD licence with the following names as copyright holders:

Markus Friedl

Theo de Raadt

Niels Provos

Dug Song

Kevin Steves

Daniel Kouril

Wesley Griffin

Per Allansson

Jason Downs

Solar Designer

Todd C. Miller

Redistribution and use in source and binary forms, with or without modification, are permitted provided that the following conditions are met:

1. Redistributions of source code must retain the above copyright notice, this list of conditions and the following disclaimer.
2. Redistributions in binary form must reproduce the above copyright notice, this list of conditions and the following disclaimer in the documentation and/or other materials provided with the distribution.

THIS SOFTWARE IS PROVIDED BY THE AUTHOR "AS IS" AND ANY EXPRESS OR IMPLIED WARRANTIES, INCLUDING, BUT NOT LIMITED TO, THE IMPLIED WARRANTIES OF MERCHANTABILITY AND FITNESS FOR A PARTICULAR PURPOSE ARE DISCLAIMED. IN NO EVENT SHALL THE AUTHOR BE LIABLE FOR ANY DIRECT, INDIRECT, INCIDENTAL, SPECIAL, EXEMPLARY, OR CONSEQUENTIAL DAMAGES (INCLUDING, BUT NOT LIMITED TO, PROCUREMENT OF SUBSTITUTE GOODS OR SERVICES; LOSS OF USE, DATA, OR PROFITS; OR BUSINESS INTERRUPTION) HOWEVER CAUSED AND ON ANY THEORY OF LIABILITY, WHETHER IN CONTRACT, STRICT LIABILITY, OR TORT (INCLUDING NEGLIGENCE OR OTHERWISE) ARISING IN ANY WAY OUT OF THE USE OF THIS SOFTWARE, EVEN IF ADVISED OF THE POSSIBILITY OF SUCH DAMAGE.

5)

Portable OpenSSH contains the following additional licenses:

c) Compatibility code (openbsd-compat)

Apart from the previously mentioned licenses, various pieces of code in the openbsd-compat/ subdirectory are licensed as follows:

Some code is licensed under a 3-term BSD license, to the following copyright holders:

Todd C. Miller

Theo de Raadt

Damien Miller

Eric P. Allman

The Regents of the University of California

Redistribution and use in source and binary forms, with or without modification, are permitted provided that the following conditions are met:

1. Redistributions of source code must retain the above copyright notice, this list of conditions and the following disclaimer.
2. Redistributions in binary form must reproduce the above copyright notice, this list of conditions and the following disclaimer in the documentation and/or other materials provided with the distribution.
3. Neither the name of the University nor the names of its contributors may be used to endorse or promote products derived from this software without specific prior written permission.

THIS SOFTWARE IS PROVIDED BY THE REGENTS AND CONTRIBUTORS "AS IS" AND ANY EXPRESS OR IMPLIED WARRANTIES, INCLUDING, BUT NOT LIMITED TO, THE IMPLIED WARRANTIES OF MERCHANTABILITY AND FITNESS FOR A PARTICULAR PURPOSE ARE DISCLAIMED. IN NO EVENT SHALL THE REGENTS OR CONTRIBUTORS BE LIABLE FOR ANY DIRECT, INDIRECT, INCIDENTAL, SPECIAL, EXEMPLARY, OR CONSEQUENTIAL DAMAGES (INCLUDING, BUT NOT LIMITED TO, PROCUREMENT OF SUBSTITUTE GOODS OR SERVICES; LOSS OF USE, DATA, OR PROFITS; OR BUSINESS INTERRUPTION) HOWEVER CAUSED AND ON ANY THEORY OF LIABILITY, WHETHER IN CONTRACT, STRICT LIABILITY, OR TORT (INCLUDING NEGLIGENCE OR OTHERWISE) ARISING IN ANY WAY OUT OF THE USE OF THIS SOFTWARE, EVEN IF ADVISED OF THE POSSIBILITY OF SUCH DAMAGE.

Open LDAP

Copyright (c) 1999-2003 The OpenLDAP Foundation, Redwood City, California, USA. All Rights Reserved. Permission to copy and distribute verbatim copies of this document is granted.

The OpenLDAP Public License Version 2.8, 17 August 2003

Redistribution and use of this software and associated documentation ("Software"), with or without modification, are permitted provided that the following conditions are met:

1. Redistributions in source form must retain copyright statements and notices,
2. Redistributions in binary form must reproduce applicable copyright statements and notices, this list of conditions, and the following disclaimer in the documentation and/or other materials provided with the distribution, and
3. Redistributions must contain a verbatim copy of this document.

The OpenLDAP Foundation may revise this license from time to time. Each revision is distinguished by a version number. You may use this Software under terms of this license revision or under the terms of any subsequent revision of the license.

THIS SOFTWARE IS PROVIDED BY THE OPENLDAP FOUNDATION AND ITS CONTRIBUTORS "AS IS" AND ANY EXPRESSED OR IMPLIED WARRANTIES, INCLUDING, BUT NOT LIMITED TO, THE IMPLIED WARRANTIES OF MERCHANTABILITY AND FITNESS FOR A PARTICULAR PURPOSE ARE DISCLAIMED. IN NO EVENT SHALL THE OPENLDAP FOUNDATION, ITS CONTRIBUTORS, OR THE AUTHOR(S) OR OWNER(S) OF THE SOFTWARE BE LIABLE FOR ANY DIRECT, INDIRECT, INCIDENTAL, SPECIAL, EXEMPLARY, OR CONSEQUENTIAL DAMAGES (INCLUDING, BUT NOT LIMITED TO, PROCUREMENT OF SUBSTITUTE GOODS OR SERVICES; LOSS OF USE, DATA, OR PROFITS; OR BUSINESS INTERRUPTION) HOWEVER CAUSED AND ON ANY THEORY OF LIABILITY, WHETHER IN CONTRACT, STRICT LIABILITY, OR TORT (INCLUDING NEGLIGENCE OR OTHERWISE) ARISING IN ANY WAY OUT OF THE USE OF THIS SOFTWARE, EVEN IF ADVISED OF THE POSSIBILITY OF SUCH DAMAGE.

The names of the authors and copyright holders must not be used in advertising or otherwise to promote the sale, use or other dealing in this Software without specific, written prior permission. Title to copyright in this Software shall at all times remain with copyright holders.

Heimdal

Copyright (c) 1997-2005 Kungliga Tekniska Högskolan (Royal Institute of Technology, Stockholm, Sweden). All rights reserved.

Redistribution and use in source and binary forms, with or without modification, are permitted provided that the following conditions are met:

1. Redistributions of source code must retain the above copyright notice, this list of conditions and the following disclaimer.
2. Redistributions in binary form must reproduce the above copyright notice, this list of conditions and the following disclaimer in the documentation and/or other materials provided with the distribution.
3. Neither the name of the Institute nor the names of its contributors may be used to endorse or promote products derived from this software without specific prior written permission.

THIS SOFTWARE IS PROVIDED BY THE INSTITUTE AND CONTRIBUTORS "AS IS" AND ANY EXPRESS OR IMPLIED WARRANTIES, INCLUDING, BUT NOT LIMITED TO, THE IMPLIED WARRANTIES OF MERCHANTABILITY AND FITNESS FOR A PARTICULAR PURPOSE ARE DISCLAIMED. IN NO EVENT SHALL THE INSTITUTE OR CONTRIBUTORS BE LIABLE FOR ANY DIRECT, INDIRECT, INCIDENTAL, SPECIAL, EXEMPLARY, OR CONSEQUENTIAL DAMAGES (INCLUDING, BUT NOT LIMITED TO, PROCUREMENT OF SUBSTITUTE GOODS OR SERVICES; LOSS OF USE, DATA, OR PROFITS; OR BUSINESS INTERRUPTION) HOWEVER CAUSED AND ON ANY THEORY OF LIABILITY, WHETHER IN CONTRACT, STRICT LIABILITY, OR TORT (INCLUDING NEGLIGENCE OR OTHERWISE) ARISING IN ANY WAY OUT OF THE USE OF THIS SOFTWARE, EVEN IF ADVISED OF THE POSSIBILITY OF SUCH DAMAGE.

IPS™ print language emulations

Copyright (c) 1987-2006 Zoran Corporation. All rights reserved.

AppleTalk

Copyright (c) 1990, 1991 Regents of The University of Michigan. All Rights Reserved.

Permission to use, copy, modify, and distribute this software and its documentation for any purpose and without fee is hereby granted, provided that the above copyright notice appears in all copies and that both that copyright notice and this permission notice appear in supporting documentation, and that the name of The University of Michigan not be used in advertising or publicity pertaining to distribution of the software without specific, written prior permission. This software is supplied as is without expressed or implied warranties of any kind.

This product includes software developed by the University of California, Berkeley and its contributors.

SPX/IPX

Copyright (c) 1984, 1985, 1986, 1987, 1993

The Regents of the University of California. All rights reserved.

Modifications Copyright (c) 1995, Mike Mitchell

Modifications Copyright (c) 1995, John Hay

WPA Supplicant

Copyright (c) 2003-2009, Jouni Malinen <j@w1.fi> and contributors All Rights Reserved.

Redistribution and use in source and binary forms, with or without modification, are permitted provided that the following conditions are met:

1. Redistributions of source code must retain the above copyright notice, this list of conditions and the following disclaimer.
2. Redistributions in binary form must reproduce the above copyright notice, this list of conditions and the following disclaimer in the documentation and /or other materials provided with the distribution.
3. Neither the name (s) of the above-listed copyright holder (s) nor the names of its contributors may be used to endorse or promote products derived from this software without specific prior written permission.

THIS SOFTWARE IS PROVIDED BY THE COPYRIGHT HOLDERS AND CONTRIBUTORS "AS IS" AND ANY EXPRESS OR IMPLIED WARRANTIES, INCLUDING, BUT NOT LIMITED TO, THE IMPLIED WARRANTIES OF MERCHANTABILITY AND FITNESS FOR A PARTICULAR PURPOSE ARE DISCLAIMED.

IN NO EVENT SHALL THE COPYRIGHT OWNER OR CONTRIBUTORS BE LIABLE FOR ANY DIRECT, INDIRECT, INCIDENTAL, SPECIAL, EXEMPLARY, OR CONSEQUENTIAL DAMAGES (INCLUDING, BUT NOT LIMITED TO, PROCUREMENT OF SUBSTITUTE GOODS OR SERVICES; LOSS OF USE, DATA, OR PROFITS; OR BUSINESS INTERRUPTION) HOWEVER CAUSED AND ON ANY THEORY OF LIABILITY, WHETHER IN CONTRACT, STRICT LIABILITY, OR TORT (INCLUDING NEGLIGENCE OR OTHERWISE) ARISING IN ANY WAY OUT OF THE USE OF THIS SOFTWARE, EVEN IF ADVISED OF THE POSSIBILITY OF SUCH DAMAGE.

nana

Copyright (c) 1995, 1996, 1997, 1998 Phil Maker All rights reserved.

Redistribution and use in source and binary forms, with or without modification, are permitted provided that the following conditions are met:

1. Redistributions of source code must retain the above copyright notice, this list of conditions and the following disclaimer.
2. Redistributions in binary form must reproduce the above copyright notice, this list of conditions and the following disclaimer in the documentation and/or other materials provided with the distribution.

THIS SOFTWARE IS PROVIDED BY THE AUTHOR AND CONTRIBUTORS "AS IS" AND ANY EXPRESS OR IMPLIED WARRANTIES, INCLUDING, BUT NOT LIMITED TO, THE IMPLIED WARRANTIES OF MERCHANTABILITY AND FITNESS FOR A PARTICULAR PURPOSE ARE DISCLAIMED. IN NO EVENT SHALL THE AUTHOR OR CONTRIBUTORS BE LIABLE FOR ANY DIRECT, INDIRECT, INCIDENTAL, SPECIAL, EXEMPLARY, OR CONSEQUENTIAL DAMAGES (INCLUDING, BUT NOT LIMITED TO, PROCUREMENT OF SUBSTITUTE GOODS OR SERVICES; LOSS OF USE, DATA, OR PROFITS; OR BUSINESS INTERRUPTION) HOWEVER CAUSED AND ON ANY THEORY OF LIABILITY, WHETHER IN CONTRACT, STRICT LIABILITY, OR TORT (INCLUDING NEGLIGENCE OR OTHERWISE) ARISING IN ANY WAY OUT OF THE USE OF THIS SOFTWARE, EVEN IF ADVISED OF THE POSSIBILITY OF SUCH DAMAGE.

ILU

Copyright (c) 1991-1999 Xerox Corporation. All Rights Reserved.

Unlimited use, reproduction, modification, and distribution of this software and modified versions thereof is permitted. Permission is granted to make derivative works from this software or a modified version thereof.

Any copy of this software, a modified version thereof, or a derivative work must include both the above copyright notice of Xerox Corporation and this paragraph. Any distribution of this software, a modified version thereof, or a derivative work must comply with all applicable United States export control laws.

This software is made available AS IS, and XEROX CORPORATION DISCLAIMS ALL WARRANTIES, EXPRESS OR IMPLIED, INCLUDING WITHOUT LIMITATION THE IMPLIED WARRANTIES OF MERCHANTABILITY AND FITNESS FOR A PARTICULAR PURPOSE, AND NOTWITHSTANDING ANY

OTHER PROVISION CONTAINED HEREIN, ANY LIABILITY FOR DAMAGES RESULTING FROM THE SOFTWARE OR ITS USE IS EXPRESSLY DISCLAIMED, WHETHER ARISING IN CONTRACT, TORT (INCLUDING NEGLIGENCE) OR STRICT LIABILITY, EVEN IF XEROX CORPORATION IS ADVISED OF THE POSSIBILITY OF SUCH DAMAGES.

racoon

Copyright (C) 1995, 1996, 1997, and 1998 WIDE Project.

All rights reserved.

TrouSerS

THE ACCOMPANYING PROGRAM IS PROVIDED UNDER THE TERMS OF THIS COMMON PUBLIC LICENSE ("AGREEMENT"). ANY USE, REPRODUCTION OR DISTRIBUTION OF THE PROGRAM CONSTITUTES RECIPIENT'S ACCEPTANCE OF THIS AGREEMENT.

1. DEFINITIONS

"Contribution" means:

- a) in the case of the initial Contributor, the initial code and documentation distributed under this Agreement, and
- b) in the case of each subsequent Contributor:
 - i) changes to the Program, and
 - ii) additions to the Program;

where such changes and/or additions to the Program originate from and are distributed by that particular Contributor. A Contribution 'originates' from a Contributor if it was added to the Program by such Contributor itself or anyone acting on such Contributor's behalf. Contributions do not include additions to the Program which: (i) are separate modules of software distributed in conjunction with the Program under their own license agreement, and (ii) are not derivative works of the Program.

"Contributor" means any person or entity that distributes the Program.

"Licensed Patents " mean patent claims licensable by a Contributor which are necessarily infringed by the use or sale of its Contribution alone or when combined with the Program.

"Program" means the Contributions distributed in accordance with this Agreement.

"Recipient" means anyone who receives the Program under this Agreement, including all Contributors.

2. GRANT OF RIGHTS

- a) Subject to the terms of this Agreement, each Contributor hereby grants Recipient a non-exclusive, worldwide, royalty-free copyright license to reproduce, prepare derivative works of, publicly display, publicly perform, distribute and sublicense the Contribution of such Contributor, if any, and such derivative works, in source code and object code form.

b) Subject to the terms of this Agreement, each Contributor hereby grants Recipient a non-exclusive, worldwide, royalty-free patent license under Licensed Patents to make, use, sell, offer to sell, import and otherwise transfer the Contribution of such Contributor, if any, in source code and object code form. This patent license shall apply to the combination of the Contribution and the Program if, at the time the Contribution is added by the Contributor, such addition of the Contribution causes such combination to be covered by the Licensed Patents. The patent license shall not apply to any other combinations which include the Contribution. No hardware per se is licensed hereunder.

c) Recipient understands that although each Contributor grants the licenses to its Contributions set forth herein, no assurances are provided by any Contributor that the Program does not infringe the patent or other intellectual property rights of any other entity. Each Contributor disclaims any liability to Recipient for claims brought by any other entity based on infringement of intellectual property rights or otherwise. As a condition to exercising the rights and licenses granted hereunder, each Recipient hereby assumes sole responsibility to secure any other intellectual property rights needed, if any. For example, if a third party patent license is required to allow Recipient to distribute the Program, it is Recipient's responsibility to acquire that license before distributing the Program.

d) Each Contributor represents that to its knowledge it has sufficient copyright rights in its Contribution, if any, to grant the copyright license set forth in this Agreement.

3. REQUIREMENTS

A Contributor may choose to distribute the Program in object code form under its own license agreement, provided that:

- a) it complies with the terms and conditions of this Agreement; and
- b) its license agreement:

- i) effectively disclaims on behalf of all Contributors all warranties and conditions, express and implied, including warranties or conditions of title and non-infringement, and implied warranties or conditions of merchantability and fitness for a particular purpose;

- ii) effectively excludes on behalf of all Contributors all liability for damages, including direct, indirect, special, incidental and consequential damages, such as lost profits;

- iii) states that any provisions which differ from this Agreement are offered by that Contributor alone and not by any other party; and

- iv) states that source code for the Program is available from such Contributor, and informs licensees how to obtain it in a reasonable manner on or through a medium customarily used for software exchange.

When the Program is made available in source code form:

- a) it must be made available under this Agreement; and
- b) a copy of this Agreement must be included with each copy of the Program.

Contributors may not remove or alter any copyright notices contained within the Program.

Each Contributor must identify itself as the originator of its Contribution, if any, in a manner that reasonably allows subsequent Recipients to identify the originator of the Contribution.

4. COMMERCIAL DISTRIBUTION

Commercial distributors of software may accept certain responsibilities with respect to end users, business partners and the like. While this license is intended to facilitate the commercial use of the Program, the Contributor who includes the Program in a commercial product offering should do so in a manner which does not create potential liability for other Contributors. Therefore, if a Contributor includes the Program in a commercial product offering, such Contributor ("Commercial Contributor") hereby agrees to defend and indemnify every other Contributor ("Indemnified Contributor") against any losses, damages and costs (collectively "Losses") arising from claims, lawsuits and other legal actions brought by a third party against the Indemnified Contributor to the extent caused by the acts or omissions of such Commercial Contributor in connection with its distribution of the Program in a commercial product offering. The obligations in this section do not apply to any claims or Losses relating to any actual or alleged intellectual property infringement. In order to qualify, an Indemnified Contributor must: a) promptly notify the Commercial Contributor in writing of such claim, and b) allow the Commercial Contributor to control, and cooperate with the Commercial Contributor in, the defense and any related settlement negotiations. The Indemnified Contributor may participate in any such claim at its own expense.

For example, a Contributor might include the Program in a commercial product offering, Product X. That Contributor is then a Commercial Contributor. If that Commercial Contributor then makes performance claims, or offers warranties related to Product X, those performance claims and warranties are such Commercial Contributor's responsibility alone. Under this section, the Commercial Contributor would have to defend claims against the other Contributors related to those performance claims and warranties, and if a court requires any other Contributor to pay any damages as a result, the Commercial Contributor must pay those damages.

5. NO WARRANTY

EXCEPT AS EXPRESSLY SET FORTH IN THIS AGREEMENT, THE PROGRAM IS PROVIDED ON AN "AS IS" BASIS, WITHOUT WARRANTIES OR CONDITIONS OF ANY KIND, EITHER EXPRESS OR IMPLIED INCLUDING, WITHOUT LIMITATION, ANY WARRANTIES OR CONDITIONS OF TITLE, NON-INFRINGEMENT, MERCHANTABILITY OR FITNESS FOR A PARTICULAR PURPOSE. Each Recipient is solely responsible for determining the appropriateness of using and distributing the Program and assumes all risks associated with its exercise of rights under this Agreement, including but not limited to the risks and costs of program errors, compliance with applicable laws, damage to or loss of data, programs or equipment, and unavailability or interruption of operations.

6. DISCLAIMER OF LIABILITY

EXCEPT AS EXPRESSLY SET FORTH IN THIS AGREEMENT, NEITHER RECIPIENT NOR ANY CONTRIBUTORS SHALL HAVE ANY LIABILITY FOR ANY DIRECT, INDIRECT, INCIDENTAL, SPECIAL, EXEMPLARY, OR CONSEQUENTIAL DAMAGES (INCLUDING WITHOUT LIMITATION LOST PROFITS), HOWEVER CAUSED AND ON ANY THEORY OF LIABILITY, WHETHER IN CONTRACT, STRICT LIABILITY, OR TORT (INCLUDING NEGLIGENCE OR OTHERWISE) ARISING IN ANY WAY OUT OF THE USE OR DISTRIBUTION OF THE PROGRAM OR THE EXERCISE OF ANY RIGHTS GRANTED HEREUNDER, EVEN IF ADVISED OF THE POSSIBILITY OF SUCH DAMAGES.

7. GENERAL

If any provision of this Agreement is invalid or unenforceable under applicable law, it shall not affect the validity or enforceability of the remainder of the terms of this Agreement, and without further action by the

parties hereto, such provision shall be reformed to the minimum extent necessary to make such provision valid and enforceable.

If Recipient institutes patent litigation against a Contributor with respect to a patent applicable to software (including a cross-claim or counterclaim in a lawsuit), then any patent licenses granted by that Contributor to such Recipient under this Agreement shall terminate as of the date such litigation is filed. In addition, if Recipient institutes patent litigation against any entity (including a cross-claim or counterclaim in a lawsuit) alleging that the Program itself (excluding combinations of the Program with other software or hardware) infringes such Recipient's patent(s), then such Recipient's rights granted under Section 2(b) shall terminate as of the date such litigation is filed.

All Recipient's rights under this Agreement shall terminate if it fails to comply with any of the material terms or conditions of this Agreement and does not cure such failure in a reasonable period of time after becoming aware of such noncompliance. If all Recipient's rights under this Agreement terminate, Recipient agrees to cease use and distribution of the Program as soon as reasonably practicable. However, Recipient's obligations under this Agreement and any licenses granted by Recipient relating to the Program shall continue and survive.

Everyone is permitted to copy and distribute copies of this Agreement, but in order to avoid inconsistency the Agreement is copyrighted and may only be modified in the following manner. The Agreement Steward reserves the right to publish new versions (including revisions) of this Agreement from time to time. No one other than the Agreement Steward has the right to modify this Agreement. IBM is the initial Agreement Steward. IBM may assign the responsibility to serve as the Agreement Steward to a suitable separate entity. Each new version of the Agreement will be given a distinguishing version number. The Program (including Contributions) may always be distributed subject to the version of the Agreement under which it was received. In addition, after a new version of the Agreement is published, Contributor may elect to distribute the Program (including its Contributions) under the new version. Except as expressly stated in Sections 2 (a) and 2(b) above, Recipient receives no rights or licenses to the intellectual property of any Contributor under this Agreement, whether expressly, by implication, estoppel or otherwise. All rights in the Program not expressly granted under this Agreement are reserved.

This Agreement is governed by the laws of the State of New York and the intellectual property laws of the United States of America. No party to this Agreement will bring a legal action under this Agreement more than one year after the cause of action arose. Each party waives its rights to a jury trial in any resulting litigation.

↓ Note

- To obtain the source code for opening TrouSerS (Version 0.27), which is provided with this machine, access the Web site at the following URL: <http://www.ricoh.com/support/trousers/index.html>
- TrouSerS version control is by SourceForge CVS. For methods of obtaining the source code, access the Web site at the following URL: http://sourceforge.net/cvs/?group_id=126012

Samba

For SMB transmission, this machine uses Samba.

Copyright (c) Andrew Tridgell 1994-1998

This program is free software; you can redistribute it and/or modify it under the terms of the GNU General Public License as published by the Free Software Foundation; either version 2 of the License, or (at your option) any later version.

This program is distributed in the hope that it will be useful, but WITHOUT ANY WARRANTY; without even the implied warranty of MERCHANTABILITY or FITNESS FOR A PARTICULAR PURPOSE. See the GNU General Public License along with this program; if not, write to the Free Software Foundation, Inc., 675 Mass Ave, Cambridge, MA 02139, USA.

↓ Note

- The source code for SMB transmission by this machine can be downloaded from the following website: <http://support-download.com/services/scbs>

Copyright (C) 1989, 1991 Free Software Foundation, Inc. 59 Temple Place, Suite 330, Boston, MA 02111-1307 USA Everyone is permitted to copy and distribute verbatim copies of this license document, but changing it is not allowed.

Preamble

The licenses for most software are designed to take away your freedom to share and change it. By contrast, the GNU General Public License is intended to guarantee your freedom to share and change free software--to make sure the software is free for all its users. This General Public License applies to most of the Free Software Foundation's software and to any other program whose authors commit to using it. (Some other Free Software Foundation software is covered by the GNU Library General Public License instead.) You can apply it to your programs, too.

When we speak of free software, we are referring to freedom, not price.

Our General Public Licenses are designed to make sure that you have the freedom to distribute copies of free software (and charge for this service if you wish), that you receive source code or can get it if you want it, that you can change the software or use pieces of it in new free programs; and that you know you can do these things.

To protect your rights, we need to make restrictions that forbid anyone to deny you these rights or to ask you to surrender the rights. These restrictions translate to certain responsibilities for you if you distribute copies of the software, or if you modify it.

For example, if you distribute copies of such a program, whether gratis or for a fee, you must give the recipients all the rights that you have.

You must make sure that they, too, receive or can get the source code.

And you must show them these terms so they know their rights.

We protect your rights with two steps: (1) copyright the software, and (2) offer you this license which gives you legal permission to copy, distribute and/or modify the software.

Also, for each author's protection and ours, we want to make certain that everyone understands that there is no warranty for this free software. If the software is modified by someone else and passed on, we want

its recipients to know that what they have is not the original, so that any problems introduced by others will not reflect on the original authors' reputations.

Finally, any free program is threatened constantly by software patents.

We wish to avoid the danger that redistributors of a free program will individually obtain patent licenses, in effect making the program proprietary. To prevent this, we have made it clear that any patent must be licensed for everyone's free use or not licensed at all.

The precise terms and conditions for copying, distribution and modification follow.

TERMS AND CONDITIONS FOR COPYING, DISTRIBUTION AND MODIFICATION

0. This License applies to any program or other work which contains a notice placed by the copyright holder saying it may be distributed under the terms of this General Public License. The "Program", below, refers to any such program or work, and a "work based on the Program" means either the Program or any derivative work under copyright law: that is to say, a work containing the Program or a portion of it, either verbatim or with modifications and/or translated into another language. (Hereinafter, translation is included without limitation in the term "modification".) Each licensee is addressed as "you".

Activities other than copying, distribution and modification are not covered by this License; they are outside its scope. The act of running the Program is not restricted, and the output from the Program is covered only if its contents constitute a work based on the Program (independent of having been made by running the Program). Whether that is true depends on what the Program does.

1. You may copy and distribute verbatim copies of the Program's source code as you receive it, in any medium, provided that you conspicuously and appropriately publish on each copy an appropriate copyright notice and disclaimer of warranty; keep intact all the notices that refer to this License and to the absence of any warranty; and give any other recipients of the Program a copy of this License along with the Program.

You may charge a fee for the physical act of transferring a copy, and you may at your option offer warranty protection in exchange for a fee.

2. You may modify your copy or copies of the Program or any portion of it, thus forming a work based on the Program, and copy and distribute such modifications or work under the terms of Section 1 above, provided that you also meet all of these conditions:

a) You must cause the modified files to carry prominent notices stating that you changed the files and the date of any change.

b) You must cause any work that you distribute or publish, that in whole or in part contains or is derived from the Program or any

part thereof, to be licensed as a whole at no charge to all third parties under the terms of this License.

c) If the modified program normally reads commands interactively when run, you must cause it, when started running for such

interactive use in the most ordinary way, to print or display an announcement including an appropriate copyright notice and a

notice that there is no warranty (or else, saying that you provide a warranty) and that users may redistribute the program under

these conditions, and telling the user how to view a copy of this License. (Exception: if the Program itself is interactive but does

not normally print such an announcement, your work based on the Program is not required to print an announcement.)

These requirements apply to the modified work as a whole. If identifiable sections of that work are not derived from the Program, and

can be reasonably considered independent and separate works in themselves, then this License, and its terms, do not apply to those

sections when you distribute them as separate works. But when you distribute the same sections as part of a whole which is a work based on the Program, the distribution of the whole must be on the terms of this License, whose permissions for other licensees extend to the entire whole, and thus to each and every part regardless of who wrote it.

Thus, it is not the intent of this section to claim rights or contest your rights to work written entirely by you; rather, the intent is to exercise the right to control the distribution of derivative or collective works based on the Program.

In addition, mere aggregation of another work not based on the Program with the Program (or with a work based on the Program) on a volume of a storage or distribution medium does not bring the other work under the scope of this License.

3. You may copy and distribute the Program (or a work based on it, under Section 2) in object code or executable form under the terms of Sections 1 and 2 above provided that you also do one of the following:

a) Accompany it with the complete corresponding machine-readable source code, which must be distributed under the terms of Sections

1 and 2 above on a medium customarily used for software interchange; or,

b) Accompany it with a written offer, valid for at least three years, to give any third party, for a charge no more than your

cost of physically performing source distribution, a complete machine-readable copy of the corresponding source code, to be

distributed under the terms of Sections 1 and 2 above on a medium customarily used for software interchange; or,

c) Accompany it with the information you received as to the offer to distribute corresponding source code. (This alternative is

allowed only for noncommercial distribution and only if you received the program in object code or executable form with such

an offer, in accord with Subsection b above.)

The source code for a work means the preferred form of the work for making modifications to it. For an executable work, complete source code means all the source code for all modules it contains, plus any associated interface definition files, plus the scripts used to control compilation and installation of the executable. However, as a special exception, the source code distributed need not include anything that

is normally distributed (in either source or binary form) with the major components (compiler, kernel, and so on) of the operating system on which the executable runs, unless that component itself accompanies the executable.

If distribution of executable or object code is made by offering access to copy from a designated place, then offering equivalent access to copy the source code from the same place counts as distribution of the source code, even though third parties are not compelled to copy the source along with the object code.

4. You may not copy, modify, sublicense, or distribute the Program except as expressly provided under this License. Any attempt otherwise to copy, modify, sublicense or distribute the Program is void, and will automatically terminate your rights under this License. However, parties who have received copies, or rights, from you under this License will not have their licenses terminated so long as such parties remain in full compliance.

5. You are not required to accept this License, since you have not signed it. However, nothing else grants you permission to modify or

distribute the Program or its derivative works. These actions are prohibited by law if you do not accept this License. Therefore, by

modifying or distributing the Program (or any work based on the Program), you indicate your acceptance of this License to do so, and all its terms and conditions for copying, distributing or modifying the Program or works based on it.

6. Each time you redistribute the Program (or any work based on the Program), the recipient automatically receives a license from the

original licensor to copy, distribute or modify the Program subject to these terms and conditions. You may not impose any further restrictions on the recipients' exercise of the rights granted herein. You are not responsible for enforcing compliance by third parties to this License.

7. If, as a consequence of a court judgment or allegation of patent infringement or for any other reason (not limited to patent issues), conditions are imposed on you (whether by court order, agreement or otherwise) that contradict the conditions of this License, they do not excuse you from the conditions of this License. If you cannot distribute so as to satisfy simultaneously your obligations under this License and any other pertinent obligations, then as a consequence you may not distribute the Program at all. For example, if a patent license would not permit royalty-free redistribution of the Program by all those who receive copies directly or indirectly through you, then the only way you could satisfy both it and this License would be to refrain entirely from distribution of the Program.

If any portion of this section is held invalid or unenforceable under any particular circumstance, the balance of the section is intended to apply and the section as a whole is intended to apply in other circumstances.

It is not the purpose of this section to induce you to infringe any patents or other property right claims or to contest validity of any such claims; this section has the sole purpose of protecting the integrity of the free software distribution system, which is implemented by public license practices. Many people have made generous contributions to the wide range of software distributed through that system in reliance on consistent application of that system; it is up to the author/donor to decide if he or she is willing to distribute software through any other system and a licensee cannot impose that choice.

This section is intended to make thoroughly clear what is believed to be a consequence of the rest of this License.

8. If the distribution and/or use of the Program is restricted in certain countries either by patents or by copyrighted interfaces, the original copyright holder who places the Program under this License may add an explicit geographical distribution limitation excluding those countries, so that distribution is permitted only in or among countries not thus excluded. In such case, this License incorporates the limitation as if written in the body of this License.

9. The Free Software Foundation may publish revised and/or new versions of the General Public License from time to time. Such new versions will be similar in spirit to the present version, but may differ in detail to address new problems or concerns.

Each version is given a distinguishing version number. If the Program specifies a version number of this License which applies to it and "any later version", you have the option of following the terms and conditions either of that version or of any later version published by the Free Software Foundation. If the Program does not specify a version number of this License, you may choose any version ever published by the Free Software Foundation.

10. If you wish to incorporate parts of the Program into other free programs whose distribution conditions are different, write to the

author to ask for permission. For software which is copyrighted by the Free Software Foundation, write to the Free Software Foundation; we sometimes make exceptions for this. Our decision will be guided by the two goals of preserving the free status of all derivatives of our free software and of promoting the sharing and reuse of software generally.

NO WARRANTY

11. BECAUSE THE PROGRAM IS LICENSED FREE OF CHARGE, THERE IS NO WARRANTY FOR THE PROGRAM, TO THE EXTENT PERMITTED BY APPLICABLE LAW. EXCEPT WHEN OTHERWISE STATED IN WRITING THE COPYRIGHT HOLDERS AND/OR OTHER PARTIES PROVIDE THE PROGRAM "AS IS" WITHOUT WARRANTY OF ANY KIND, EITHER EXPRESSED OR IMPLIED, INCLUDING, BUT NOT LIMITED TO, THE IMPLIED WARRANTIES OF MERCHANTABILITY AND FITNESS FOR A PARTICULAR PURPOSE. THE ENTIRE RISK AS TO THE QUALITY AND PERFORMANCE OF THE PROGRAM IS WITH YOU. SHOULD THE PROGRAM PROVE DEFECTIVE, YOU ASSUME THE COST OF ALL NECESSARY SERVICING, REPAIR OR CORRECTION.

12. IN NO EVENT UNLESS REQUIRED BY APPLICABLE LAW OR AGREED TO IN WRITING WILL ANY COPYRIGHT HOLDER, OR ANY OTHER PARTY WHO MAY MODIFY

AND/OR REDISTRIBUTE THE PROGRAM AS PERMITTED ABOVE, BE LIABLE TO YOU FOR DAMAGES, INCLUDING ANY GENERAL, SPECIAL, INCIDENTAL OR CONSEQUENTIAL DAMAGES ARISING OUT OF THE USE OR INABILITY TO USE THE PROGRAM (INCLUDING BUT NOT LIMITED TO LOSS OF DATA OR DATA BEING RENDERED INACCURATE OR LOSSES SUSTAINED BY YOU OR THIRD PARTIES OR A FAILURE OF THE PROGRAM TO OPERATE WITH ANY OTHER PROGRAMS), EVEN IF SUCH HOLDER OR OTHER PARTY HAS BEEN ADVISED OF THE POSSIBILITY OF SUCH DAMAGES.

END OF TERMS AND CONDITIONS

How to Apply These Terms to Your New Programs

If you develop a new program, and you want it to be of the greatest possible use to the public, the best way to achieve this is to make it free software which everyone can redistribute and change under these terms.

To do so, attach the following notices to the program. It is safest to attach them to the start of each source file to most effectively convey the exclusion of warranty; and each file should have at least the "copyright" line and a pointer to where the full notice is found.

one line to give the program's name and a brief idea of what it does. Copyright (C)

This program is free software; you can redistribute it and/or modify it under the terms of the GNU General Public License as

published by the Free Software Foundation; either version 2 of the License, or (at your option) any later version.

This program is distributed in the hope that it will be useful, but WITHOUT ANY WARRANTY; without even the implied warranty of

MERCHANTABILITY or FITNESS FOR A PARTICULAR PURPOSE. See the GNU General Public License for more details.

You should have received a copy of the GNU General Public License along with this program; if not, write to the Free Software

Foundation, Inc., 59 Temple Place, Suite 330, Boston, MA

02111-1307 USA

Also add information on how to contact you by electronic and paper mail.

If the program is interactive, make it output a short notice like this when it starts in an interactive mode:

Gnomovision version 69, Copyright (C) year name of author Gnomovision comes with ABSOLUTELY NO WARRANTY; for details type

`show w'. This is free software, and you are welcome to redistribute it under certain conditions; type `show c' for details.

The hypothetical commands `show w' and `show c' should show the appropriate parts of the General Public License. Of course, the commands you use may be called something other than `show w' and `show c'; they could even be mouse-clicks or menu items--whatever suits your program.

You should also get your employer (if you work as a programmer) or your school, if any, to sign a "copyright disclaimer" for the program, if necessary. Here is a sample; alter the names:

Yoyodyne, Inc., hereby disclaims all copyright interest in the program `Gnomovision' (which makes passes at compilers)

written by James Hacker.

signature of Ty Coon, 1 April 1989

Ty Coon, President of Vice

This General Public License does not permit incorporating your program into proprietary programs. If your program is a subroutine library, you may consider it more useful to permit linking proprietary applications

with the library. If this is what you want to do, use the GNU Library General Public License instead of this License.

INDEX

A

Administrator mode.....	158
Advanced printing.....	39
Alert indicator.....	15
AutoNet.....	211

B

Before using the printer.....	17
Black over print.....	205
Both sides of sheets.....	32

C

Canceling a print job.....	85
CD-ROM.....	19
Changing the paper tray settings.....	61
Citrix Presentation Server.....	209
Citrix XenApp.....	209
Classification code.....	162
Classification code for a print job.....	55
Classification code, configuring.....	163
CMYK simulation profile.....	206
Collate.....	47
Color mode.....	202
Color profile.....	204
Color setting.....	203
Combining multiple pages into single page.....	35
Commands.....	53
Configuration page.....	119
Control panel.....	14
Copyright information.....	218
Counter.....	120
Cover sheets.....	42

D

Data in indicator.....	15
Default settings.....	29
DeskTopBinder.....	21
DeskTopBinder Lite.....	21, 50, 51
Function Palette.....	51
DeskTopBinder Professional.....	21
DHCP.....	211
DHCPv6.....	211
Dial-up router.....	216
Display.....	15

Dithering.....	204
Downloading utility software.....	21
Dynamic DNS.....	213

E

E-Mail notification.....	168
Economy color.....	201
Error log.....	153
Escape key.....	14

F

Finishing menu.....	39
Fit to paper.....	201
Form feed.....	61
Frequently used print methods.....	30
Function palette.....	51

G

Gradation.....	203
Gray reproduction.....	205
Guest mode.....	158
Guide to the printer.....	14

H

Hold print.....	75, 82
Host interface.....	145
How to read this manual.....	8

I

Image smoothing.....	202
Interrupt printing function.....	57
IPP.....	167

J

Job reset.....	62
Job reset key.....	14

L

Language.....	152
Limitations.....	209
List of options.....	13
List/Test print.....	119
Locked print.....	82

M

Mac OS.....	86
-------------	----

Machine types.....	9
Maintenance.....	110
Making printer default settings.....	27
Making printer settings.....	28
Manuals for this printer.....	11
Memory erase status.....	104
Menu key.....	14
Model-specific information.....	9

N

NetWare.....	177
NetWare 3.x.....	177, 182
NetWare 4.x.....	179, 183
NetWare 5.....	179, 180, 183
NetWare 5.1.....	179, 180, 183
NetWare 6.....	179, 180, 183
NetWare 6.5.....	179, 180, 183
Number keys.....	15

O

OK key.....	15
On-demand e-mail.....	171
One click presets.....	29
Options menu.....	153
Orientation override.....	206

P

Paper input.....	105
Paper menu.....	39
Paper type.....	200
PDF direct print.....	50, 51, 52
PDF password.....	53
PictBridge.....	87
PictBridge printing.....	88
PictBridge, camera memo printing.....	95
PictBridge, color matching.....	94
PictBridge, date and file name printing.....	91
PictBridge, duplex printing.....	94
PictBridge, exiting.....	96
PictBridge, form printing.....	95
PictBridge, functions.....	89
PictBridge, image print size.....	91
PictBridge, index printing.....	89
PictBridge, multi image layout.....	92

PictBridge, paper size.....	91
PictBridge, paper type.....	94
PictBridge, printing quality.....	94
PictBridge, toner saving.....	95
PictBridge, trimming.....	90
PostScript 3 printer driver.....	187
Power indicator.....	14
Print command priority.....	40
Print job function.....	65
Print job screen.....	65
Print server.....	177, 179
Print settings.....	130
Printer driver.....	19, 55
Printer driver priority.....	40
Printer driver setting screen.....	27
Printer server.....	175
Printer status.....	168
Proceeding with printing using the bypass tray.....	63
Pure IP environment.....	180

R

Remote printer.....	182, 183
Resolution.....	201
Rotate by 180 degrees.....	206

S

Sample print.....	82
ScanRouter.....	21
Scroll keys.....	14
Security options.....	140
Selected tray.....	62
Selection keys.....	14
Sending a PDF file.....	53
Separate into CMYK.....	206
Slip sheets.....	43
SmartDeviceMonitor for Admin.....	21, 166
SmartDeviceMonitor for Client.....	22, 167, 175
Spool printing.....	48
Standard printing.....	30
Store and Print.....	187
Stored print.....	82
Supported printer drivers.....	209
Suspend/resume key.....	14

Switch functions key.....	14
System.....	124, 130

T

Troubleshooting, PictBridge.....	97
Types of combined printing.....	36
Types of duplex printing.....	34

U

User authentication.....	23, 158
User ID.....	82
Utility software.....	21

V

Virtual printer.....	57
----------------------	----

W

Watermark.....	207
Watermark angle.....	207
Watermark font.....	207
Watermark size.....	207
Watermark style.....	208
Watermark text.....	207
Watermarks.....	45
Web Image Monitor.....	155, 163, 212
Web Image Monitor help.....	160
Web Image Monitor, address book restore.....	164
Web Image Monitor, address book backup.....	164
Windows.....	85
Windows Terminal Service.....	209
WINS server.....	212
Wireless LAN.....	216

MEMO

MEMO

MEMO

Trademarks

Adobe, Acrobat, Acrobat Reader, PageMaker, PostScript, and Reader are either registered trademarks or trademarks of Adobe Systems Incorporated in the United States and/or other countries.

Apple, AppleTalk, EtherTalk, Bonjour, Macintosh, Mac OS, and Safari are registered trademarks of Apple Inc., registered in the United States and other countries.

Citrix, Citrix Presentation Server and Citrix XenApp are either registered trademarks or trademarks of Citrix Systems, Inc in the United States and/or other countries.

IPS is a trademark or registered trademark of Zoran Corporation and/ or its subsidiaries in the United States or other countries.

Microsoft®, Windows®, Windows Server®, and Windows Vista® are either registered trademarks or trademarks of Microsoft Corporation in the United States and/or other countries.

Monotype is a registered trademark of Monotype Imaging, Inc.

Netware, IPX, IPX/SPX are either registered trademarks or trademarks of Novell, Inc.

OpenLDAP is a registered trademark of the OpenLDAP Foundation.

PCL® is a registered trademark of Hewlett-Packard Company.

PictBridge is a trademark.

UNIX is a registered trademark of The Open Group.

UPnP™ is a trademark of the UPnP Implementers Corporation.

Other product names used herein are for identification purposes only and might be trademarks of their respective companies. We disclaim any and all rights to those marks.

The proper names of the Windows operating systems are as follows:

* The product names of Windows 2000 are as follows:

Microsoft® Windows® 2000 Professional

Microsoft® Windows® 2000 Server

Microsoft® Windows® 2000 Advanced Server

Microsoft® Windows® 2000 Datacenter Server

* The product names of Windows XP are as follows:

Microsoft® Windows® XP Professional

Microsoft® Windows® XP Home Edition

Microsoft® Windows® XP Media Center Edition

Microsoft® Windows® XP Tablet PC Edition

Microsoft® Windows® XP Professional x 64 Edition

* The product names of Windows Vista are as follows:

Microsoft® Windows Vista® Ultimate

Microsoft® Windows Vista® Business

Microsoft® Windows Vista® Home Premium

Microsoft® Windows Vista® Home Basic

Microsoft® Windows Vista® Enterprise

* The product names of Windows Server 2003 are as follows:

Microsoft® Windows Server® 2003 Standard Edition

Microsoft® Windows Server® 2003 Enterprise Edition

Microsoft® Windows Server® 2003 Web Edition

Microsoft® Windows Server® 2003 Datacenter Edition

* The product names of Windows Server 2003 R2 are as follows:

Microsoft® Windows Server® 2003 R2 Standard Edition

Microsoft® Windows Server® 2003 R2 Enterprise Edition

Microsoft® Windows Server® 2003 R2 Datacenter Edition

* The product names of Windows Server 2008 are as follows:

Microsoft® Windows Server® 2008 Foundation

Microsoft® Windows Server® 2008 Standard

Microsoft® Windows Server® 2008 Enterprise

Microsoft® Windows Server® 2008 Datacenter





Read this manual carefully before you use the product and keep it handy for future reference. For safe and correct use, please be sure to read "Safety Information" before using the machine. This manual briefly describes the procedure for installing this machine. For more details about installation and other information, see *Hardware Guide* in the CD-ROM and *Driver Installation Guide* provided on the driver CD-ROM.

Lesen Sie diese Anleitung bitte sorgfältig, bevor Sie das Produkt verwenden, und bewahren Sie die Anleitung griffbereit auf. Zur Gewährleistung des sicheren und richtigen Umgangs mit dem Gerät sollten Sie unbedingt die „Sicherheitshinweise“ durchlesen, bevor Sie das Gerät einsetzen. Dieses Handbuch beschreibt in Kurzform das Verfahren zur Installation dieses Geräts. Details zur Installation sowie weitere Informationen finden Sie in der *Hardware-Anleitung* auf der CD-ROM und in der *Treiber-Installationsanleitung* auf der Treiber-CD-ROM.

Veillez lire ce manuel avec attention avant d'utiliser l'appareil et conservez-le à portée de main pour une consultation ultérieure. Afin de garantir une utilisation correcte et sans danger, lisez attentivement les *Consignes de sécurité* avant d'utiliser l'appareil. Le présent manuel décrit brièvement la procédure d'installation de cet appareil. Pour plus d'informations sur l'installation et sur d'autres sujets, voir le *Manuel du matériel* sur le CD-ROM et le *Manuel d'installation du pilote* présent sur le CD-ROM du pilote.

Si raccomanda di leggere attentamente questo manuale prima di usare il prodotto e di conservarlo in un luogo facilmente accessibile per poterlo consultare in seguito. Per un uso sicuro e corretto dell'apparecchio, leggere le "Informazioni sulla sicurezza" prima di utilizzarlo. Il presente manuale descrive brevemente la procedura per l'installazione della macchina. Per maggiori dettagli sull'installazione e per ulteriori informazioni, consultare la *Guida per l'hardware* sul CD-ROM e la *Guida all'installazione del driver* fornita sul CD-ROM del driver.

Lea detenidamente este manual antes de utilizar el producto y téngalo a mano para futuras consultas. Asegúrese de leer la "Información de seguridad" antes de utilizar esta máquina para un uso seguro y correcto. Este manual describe brevemente el procedimiento de instalación de la máquina. Para obtener más información sobre la instalación y otros aspectos, consulte el *Manual de hardware* del CD-ROM y la *Guía de instalación del driver* incluida con el CD-ROM de drivers.

Lees deze handleiding aandachtig door voor u dit product in gebruik neemt en bewaar deze op een handige plaats voor latere naslag. Neem vóór gebruik de "Veiligheidsinformatie" goed door. Hierin wordt beschreven hoe u het apparaat op een veilige en correcte manier gebruikt. In deze handleiding wordt de procedure voor de installatie van deze machine bondig beschreven. Voor meer informatie over de installatie en andere informatie, verwijzen we naar de *Hardwarehandleiding* op de cd-rom en *Installatiehandleiding stuurprogramma* op de cd-rom van het stuurprogramma.

Leia cuidadosamente este manual antes de utilizar o produto e guarde-o num local acessível para consulta futura. Para uma utilização segura e correcta, leia as "Informações de Segurança" antes de utilizar o equipamento. Este manual descreve resumidamente o procedimento de instalação do equipamento. Para mais informações sobre a instalação e outras informações, consulte o *Guia de Hardware* no CD-ROM e o *Guia de instalação do Driver* fornecido no CD-ROM do driver.

1 Place to Install

Installationsort Emplacement pour l'installation Luogo di installazione Lugar de instalación Plaats van installatie Local de Instalação

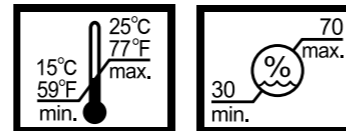
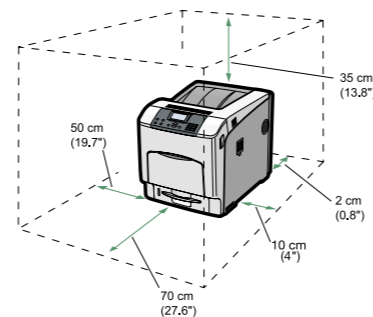

- ❖ **Power Source**
 - 120 - 127 V, 60 Hz, 12 A or more
 - 220 - 240 V, 50/60 Hz, 8 A or more
- ❖ **Stromversorgung**
 - 120 - 127 V, 60 Hz, mindestens 12 A
 - 220 - 240 V, 50/60 Hz, mindestens 8 A
- ❖ **Source d'alimentation**
 - 120 - 127 V, 60 Hz, 12 A ou plus
 - 220 - 240 V, 50/60 Hz, 8 A ou plus
- ❖ **Alimentazione**
 - 120 - 127 V, 60 Hz, 12 A o superiore
 - 220 - 240 V, 50/60 Hz, 8 A o superiore
- ❖ **Fuente de alimentación**
 - 120 - 127 V, 60 Hz, 12 A o más
 - 220 - 240 V, 50/60 Hz, 8 A o más
- ❖ **Stroombron**
 - 120 - 127 V, 60 Hz, 12 A of meer
 - 220 - 240 V, 50/60 Hz, 8 A of meer
- ❖ **Fonte de alimentação**
 - 120 - 127 V, 60 Hz, 12 A ou mais
 - 220 - 240 V, 50/60 Hz, 8 A ou mais

2 Checking the Contents of the Box

Überprüfen des Verpackungsinhalts Contrôle du contenu de la boîte Controllo del contenuto della confezione Comprobación del contenido del paquete De inhoud van de doos controleren Verificar os Conteúdos da Embalagem

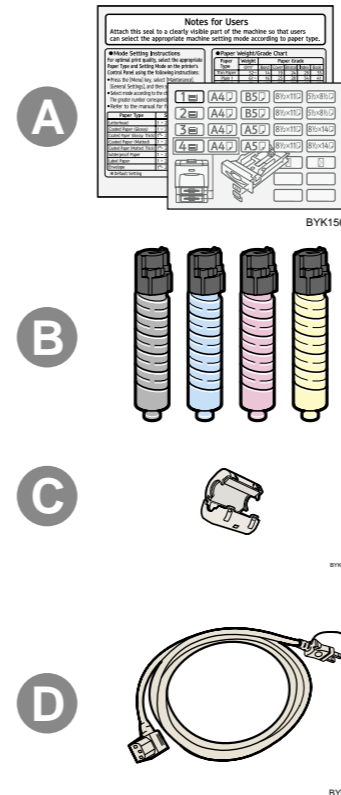

3 Removing the Packaging Materials

Entfernen der Verpackungsmaterialien Retrait de l'emballage Rimozione dell'imballaggio Proceso de desembalaje Het verpakkingsmateriaal verwijderen Remover os Materiais de Embalagem

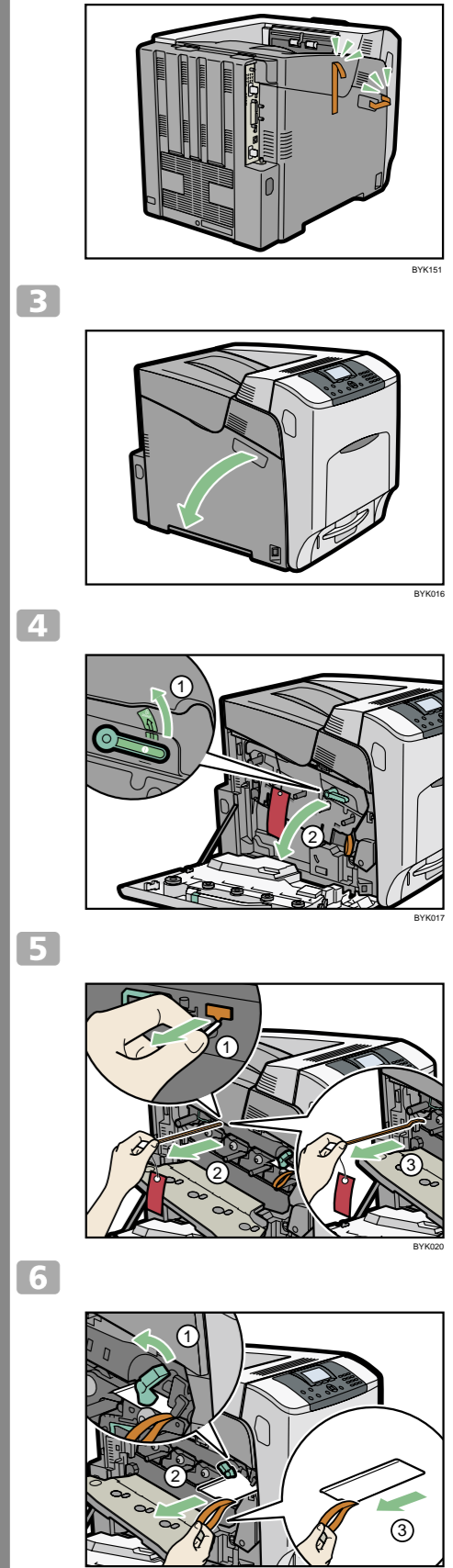
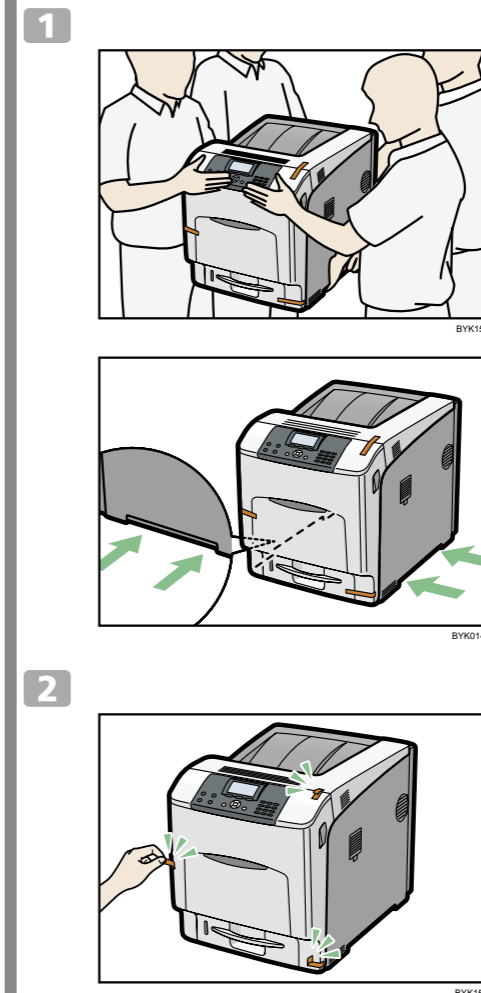

7

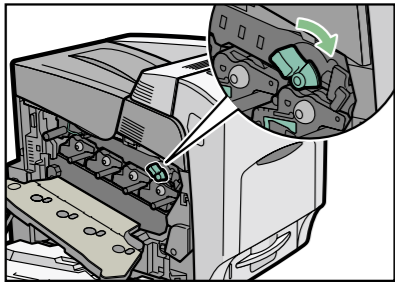

BYK023

8

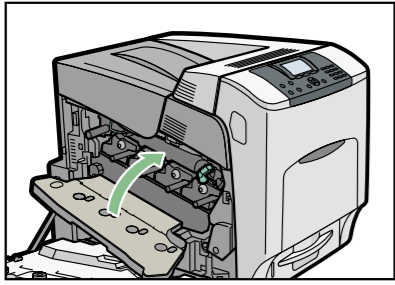

BYK024

9

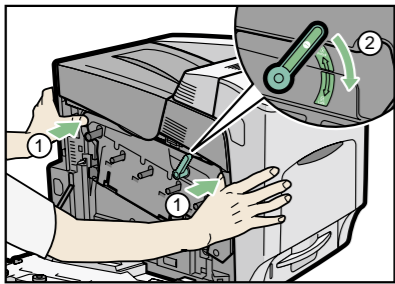

BYK141

10

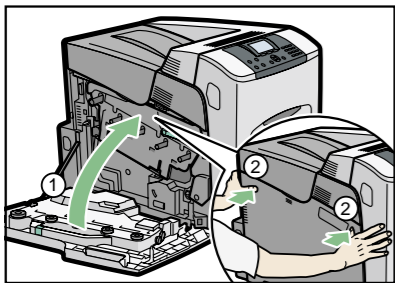

BYK149

11

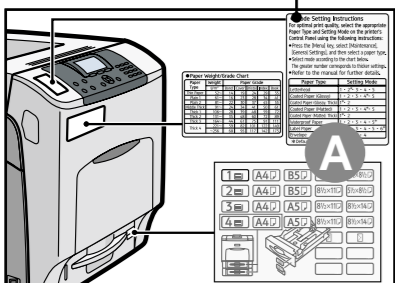

BYK028

4 Installing the Toner

Installieren des Toners
 Installation du toner
 Installazione del toner
 Instalación del tóner
 De toner plaatsen
 Instalar o Toner

1

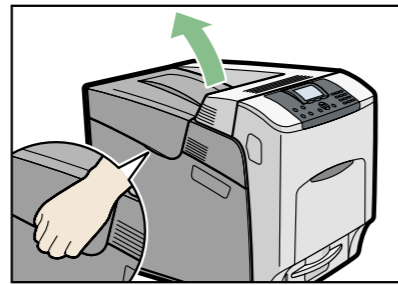

BYK025

2

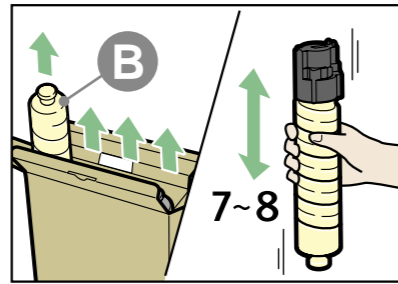

BYK152

3

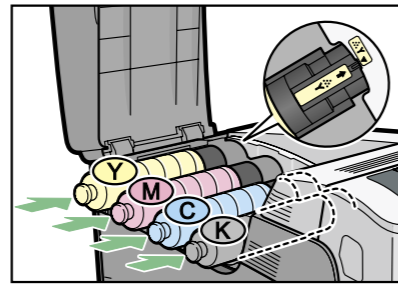

BYK113

4

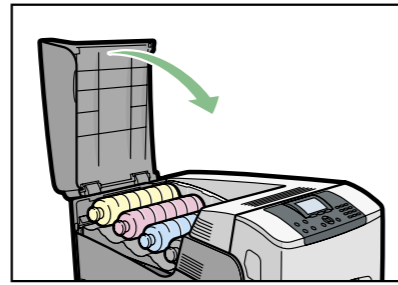

BYK115

5 Loading Paper

Einlegen von Papier
 Chargement du papier
 Caricamento della carta
 Carga de papel
 Papier plaatsen
 Colocar Papel

1

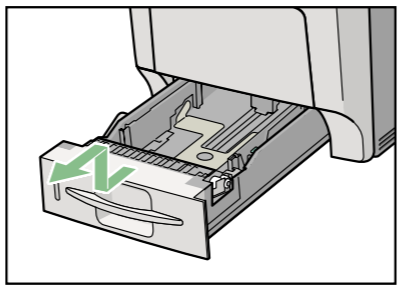

BYK078

2

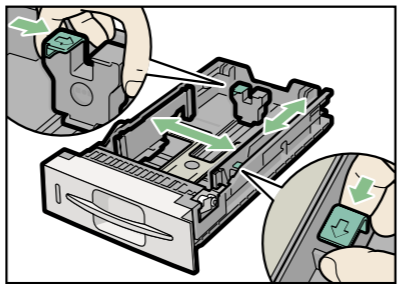

BYK079

3

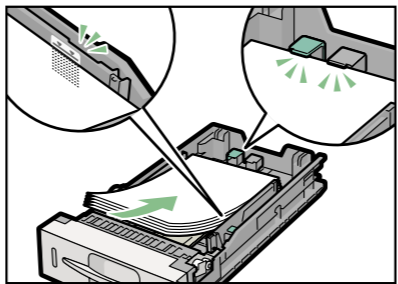

BYK080

4

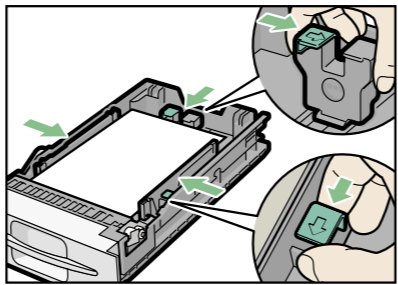

BYK081

5

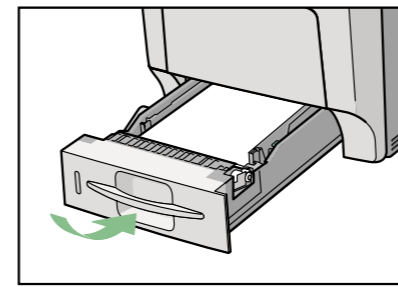

BYK082

6 Connection

Anschluss
 Connexion
 Connessione
 Conexión
 Verbinding
 Ligação

- For details about connection settings, see *Hardware Guide*.
- Details zu den Anschlusseinstellungen finden Sie in der *Hardware-Anleitung*.
- Pour plus d'informations sur les paramètres de connexion, reportez-vous au *Manuel du matériel*.
- Per ulteriori informazioni sulle impostazioni della connessione, vedere la *Guida per l'hardware*.
- Para obtener más información sobre los ajustes de conexión, consulte el *Manual de hardware*.
- Raadpleeg de *Hardwarehandleiding* voor informatie over de verbindinginstellingen.
- Para mais informações sobre as definições de ligação, consulte o *Guia de Hardware*.

LAN

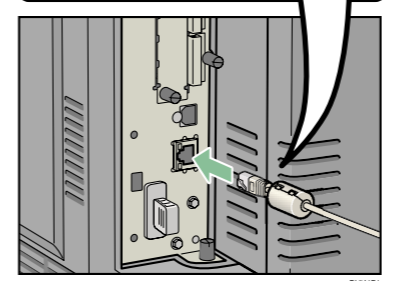
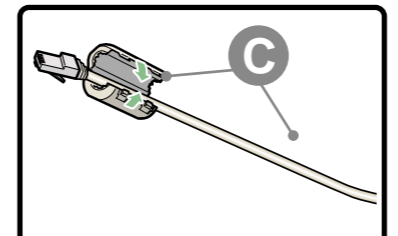

BYK171

USB

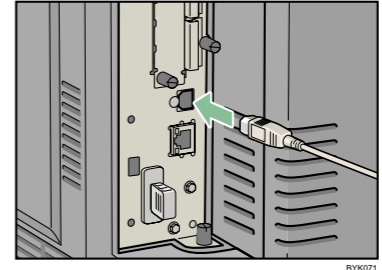

BYK071

7 Turning the Power On

Einschalten des Geräts
 Mise sous tension
 Accensione
 Encendido de la máquina
 De spanning inschakelen
 Ligar o Equipamento

1

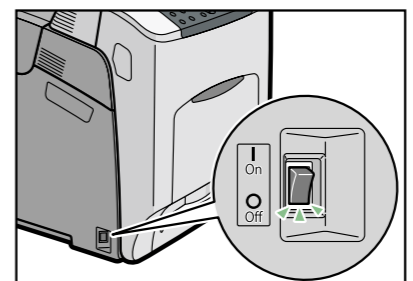

BYK033

2

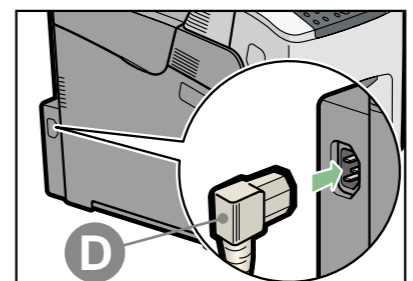

BYK034

3

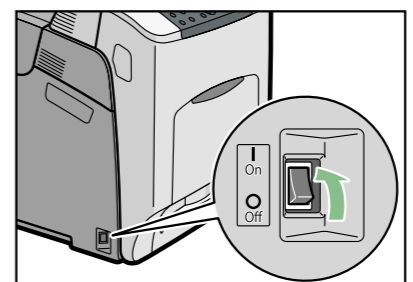

BYK035

8 Installing the Printer Driver

Installieren des Druckertreibers
 Installation du pilote d'impression
 Installazione del driver della stampante
 Instalación del driver de impresora
 Het printerstuurprogramma installeren
 Instalar o Driver de Impressão

- For details about connection and installation of the printer driver when using network connection, see *Driver Installation Guide*.
- Details zum Anschließen und zur Installation des Druckertreibers bei Verwendung einer Netzwerkverbindung finden Sie in der *Treiber-Installationsanleitung*.
- Pour plus de détails sur la connexion et l'installation du pilote d'impression lors de l'utilisation d'une connexion réseau, reportez-vous au *Manuel d'installation du pilote*.
- Per ulteriori dettagli sulla connessione e l'installazione del driver della stampante quando si utilizzano connessioni di rete, vedere *Guida all'installazione del driver*.
- Para obtener más información acerca de la conexión y la instalación del driver de impresora a través de la conexión de red, consulte la *Guía de instalación del driver*.
- Raadpleeg de *Installatiehandleiding stuurprogramma* voor meer informatie over de verbinding en de installatie van het printerstuurprogramma bij gebruik van de netwerkverbinding.
- Para mais informações sobre a ligação e instalação do driver de impressão numa ligação de rede, consulte o *Guia de Instalação do Driver*.

Copyright © 2010
 EN (US) DE (DE)
 FR (FR) IT (IT)
 ES (ES) NL (NL)
 PT (PT) M066-8508



Operating Instructions

Driver Installation Guide

-
- 1 About Quick Install
 - 2 Network Connection
 - 3 Local Connection
 - 4 When Using the Printer under Mac OS
 - 5 Appendix

Introduction

This manual contains detailed instructions and notes on the operation and use of this machine. For your safety and benefit, read this manual carefully before using the machine. Keep this manual in a handy place for quick reference.

Do not copy or print any item for which reproduction is prohibited by law.

Copying or printing the following items is generally prohibited by local law:

bank notes, revenue stamps, bonds, stock certificates, bank drafts, checks, passports, driver's licenses.

The preceding list is meant as a guide only and is not inclusive. We assume no responsibility for its completeness or accuracy. If you have any questions concerning the legality of copying or printing certain items, consult with your legal advisor.

Important

Contents of this manual are subject to change without prior notice.

In no event will the company be liable for direct, indirect, special, incidental, or consequential damages as a result of handling or operating the machine.

For good print quality, the manufacturer recommends that you use genuine toner from the manufacturer.

The manufacturer shall not be responsible for any damage or expense that might result from the use of parts other than genuine parts from the manufacturer with your office products.

Some illustrations in this manual might be slightly different from the machine.

Certain options might not be available in some countries. For details, please contact your local dealer.

TABLE OF CONTENTS

How to Read This Manual.....	3
Symbols.....	3
Installing the Printer Drivers.....	4
1. About Quick Install	
Quick Install.....	5
2. Network Connection	
Confirming the Connection Method.....	7
Using This Printer as the Windows Printing Port.....	7
Using as the Network Printer.....	8
Installing the Printer Driver for the Selected Port.....	10
Using the Standard TCP/IP Port.....	10
Using the IPP Port.....	13
Using the LPR Port.....	15
Using the WSD Port.....	18
Using the SmartDeviceMonitor for Client Port.....	20
Using as the Windows Network Printer.....	28
Installing the PCL printer driver.....	28
Installing the PostScript 3 printer driver.....	29
Using as the NetWare Print Server/Remote Printer.....	31
When using the PostScript 3 Printer Driver.....	32
Form Feed.....	33
Banner Page.....	33
Printing after Resetting the Printer.....	33
3. Local Connection	
Installing the Printer Driver Using USB.....	35
Windows 2000 - USB.....	35
Windows XP, Windows Server 2003/2003 R2 - USB.....	36
Windows Vista, Windows Server 2008 - USB.....	37
Troubleshooting USB.....	39
Installing the Printer Driver Using Parallel Cable.....	40
Installing the PCL Printer Driver.....	40
Installing the PostScript 3 Printer Driver.....	41

4. When Using the Printer under Mac OS

Installing the Printer.....	45
Installing the PPD Files.....	45
Setting Up the PPD File.....	46
Setting Up Options for Mac OS X.....	46
Using USB Interface.....	47
Using Bonjour.....	48
Changing to EtherTalk.....	48

5. Appendix

Messages Displayed When Installing the Printer Driver.....	51
Windows 2000.....	51
Windows XP Professional or Windows Server 2003/2003 R2.....	51
Windows XP Home Edition.....	52
Windows Vista, Windows Server 2008.....	52
Making Option Settings for the Printer.....	54
Conditions for Bidirectional Communication.....	54
If Bidirectional Communication Is Disabled.....	55
Installing Font Manager.....	56
Using Adobe PageMaker Version 6.0, 6.5, or 7.0.....	57
Trademarks.....	58
INDEX	61

How to Read This Manual

Symbols

This manual uses the following symbols:

Important

Indicates points to pay attention to when using the machine, and explanations of likely causes of paper misfeeds, damage to originals, or loss of data. Be sure to read these explanations.

Note

Indicates supplementary explanations of the machine's functions, and instructions on resolving user errors.

Reference

This symbol is located at the end of sections. It indicates where you can find further relevant information.

[]

Indicates the names of keys on the machine's display or control panels.

Installing the Printer Drivers

This section provides a brief overview of the procedures for installing the printer drivers under Windows and Mac OS.

Windows Installation

- Quick Install

This method allows you to install the printer drivers easily from the CD-ROM provided.

If you select this installation method, the standard TCP/IP port will be automatically specified, and the PCL 6 driver will be installed across the network environment.

- Installation according to environment

You can manually specify which port you want to use, based on the configuration of your environment.

This method also allows you to configure the PCL 5e/5c and PostScript 3 drivers to print over a network or through a local connection.

If you install SmartDeviceMonitor for Client on your computer, the SmartDeviceMonitor for Client port will also be available. This port allows you to monitor the printer's status and check the results of its jobs.

Choose the installation method that is most appropriate for your environment, intended purpose, and connection type.

Mac OS Installation

If you install the PPD file for this printer into a Mac OS, you can print over a network (using Bonjour) or through a local connection.

Note

- You can install the printer driver from the CD-ROM provided with this printer or download it from the manufacturer's Web site.
- If your operating system is Windows XP Pro x64, Windows Vista x64, or Windows Server 2003 x64/2003 R2 x64/2008 x64, you must download the printer driver from the manufacturer's Web site. Select this printer and the operating system you are using, and then download it.

1. About Quick Install

This chapter explains the "Quick Install" procedure. This installation method allows users to install the drivers easily, and requires minimal manual settings.

Quick Install

You can install the printer drivers easily from the CD-ROM provided with this printer.

Using Quick Install, the PCL 6 printer driver is installed under network environment, and the Standard TCP/IP port will be set.

★ Important

- **Manage Printers permission is required to install the drivers. Log on as an Administrators group member.**
- **If you connect using USB, see "Installing the Printer Driver Using USB" and install the printer driver.**

1. **Quit all applications currently running.**
2. **Insert the CD-ROM into the CD-ROM drive.**

The installer starts.

Auto Run may not work with certain operating system settings. If this happens, launch "Setup.exe" on the CD-ROM root directory.

3. **Select an interface language, and then click [OK].**

The default interface language is English.

4. **Click [Quick Install].**

The software license agreement appears in the [License Agreement] dialog box.

5. **After reading the agreement, click [I accept the agreement.] and then click [Next >].**

6. **Select the printer model you want to use in the [Select Printer] dialog box.**

For network connection via TCP/IP, select the printer whose IP address is displayed in [Connect To].

For parallel connection, select the printer whose printer port is displayed in [Connect To].

7. **Click [Install].**

The printer driver installation starts.

The PCL 6 printer driver is installed in the language specified by your operating system.

8. **Click [Finish].**

A message about restarting the computer appears. Restart the computer to complete the installation.

9. **Click [Exit] in the first dialog box of the installer, and then take out the CD-ROM.**

↓ Note

- To stop installation of the selected software, click [Cancel] before the installation is complete.

- Select a printer whose IP address is displayed in [Connect To] to install SmartDeviceMonitor for Client when using TCP/IP.
- Quick Install is not available unless bidirectional communication between the printer and computer is enabled via parallel connection. For details about bidirectional communication between the printer and computer, see "Making Option Settings for the Printer".

 **Reference**

- p.35 "Installing the Printer Driver Using USB"
- p.54 "Making Option Settings for the Printer"

2. Network Connection

This chapter explains how to install the printer driver under Windows for a network-connected printer.

Before installing the printer driver, check how the printer is connected. Follow the driver installation procedure that is appropriate for the connection method.

Confirming the Connection Method

2

This printer can be used as the Windows printing port or network printer.

Using This Printer as the Windows Printing Port

Network connections can be established through Ethernet and Wireless LAN.

Available ports are determined based on the combination of the Windows operating system version and connection method used.

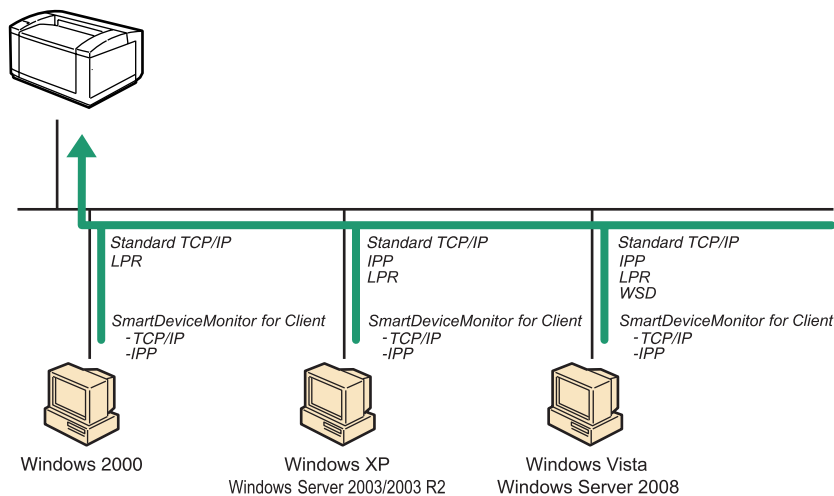

BYK599

Windows 2000/XP, Windows Server 2003/2003 R2

Connection Method	Available Ports
<ul style="list-style-type: none">EthernetWireless LAN	<ul style="list-style-type: none">Standard TCP/IP portIPP portLPR portSmartDeviceMonitor for Client port

Windows Vista, Windows Server 2008

Connection Method	Available Ports
<ul style="list-style-type: none"> • Ethernet • Wireless LAN 	<ul style="list-style-type: none"> • Standard TCP/IP port • IPP port • LPR port • WSD port • SmartDeviceMonitor for Client port

Note

- See the explanation about how to install the printer driver for each type of ports.
- For details about the Standard TCP/IP port, see "Using the Standard TCP/IP port".
- For details about the IPP port, see "Using the IPP port".
- For details about the LPR port, see "Using the LPR port".
- For details about the WSD port, see "Using the WSD port".
- For details about the SmartDeviceMonitor for Client port, see "Using the SmartDeviceMonitor for Client port".

Reference

- p.10 "Using the Standard TCP/IP Port"
- p.13 "Using the IPP Port"
- p.15 "Using the LPR Port"
- p.18 "Using the WSD Port"
- p.20 "Using the SmartDeviceMonitor for Client Port"

Using as the Network Printer

This printer can be used as the Windows network printer, a NetWare print server, or a NetWare remote printer.

Important

- IPX/SPX (NetWare) cannot be used under Windows Vista and Windows Server 2008.

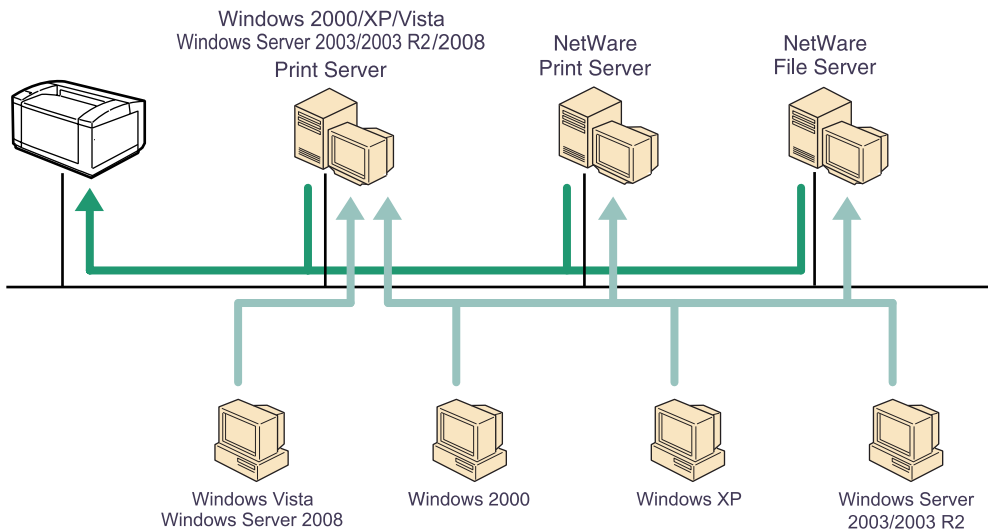

BVP501

Note

- In an IPv6 environment, NetWare servers cannot be used.
- See the explanation about how to install the printer driver for each type of network printers.
- For details about Windows network printer, see "Using as the Windows Network Printer".
- For details about a NetWare print server and remote printer, see "Using as the NetWare Print Server/Remote Printer".

Reference

- p.28 "Using as the Windows Network Printer"
- p.31 "Using as the NetWare Print Server/Remote Printer"

Installing the Printer Driver for the Selected Port

You can install the appropriate driver according to the port you want to use.

2

Using the Standard TCP/IP Port

This describes how to install the PCL 5e/5c/6 or PostScript 3 printer drivers using the Standard TCP/IP port.

★ Important

- **Manage Printers permission is required to install the driver. Log on as an Administrators group member.**
- **In an IPv6 environment, you cannot use the Standard TCP/IP Port. Use the SmartDeviceMonitor for Client port.**

Installing the PCL printer driver

1. **Quit all applications currently running.**
2. **Insert the CD-ROM into the CD-ROM drive.**

The installer starts.

Auto Run may not work with certain operating system settings. If this happens, launch "Setup.exe" on the CD-ROM root directory.
3. **Select an interface language, and then click [OK].**

The default interface language is English.
4. **Click [PCL Printer Driver].**
5. **The software license agreement appears in the [License Agreement] dialog box.**

After reading the agreement, click [I accept the agreement.], and then click [Next >].
6. **Select a printer driver you want to use in the [Select Program] dialog box.**

You can select several printer drivers.

The PCL 6 printer driver is installed in the language specified by your operating system.
7. **Click [Next >].**
8. **Select the printer model you want to use.**

The printer name can be changed in the [Change settings for 'Printer Name'] box.
9. **Double-click the printer name to display the printer settings.**

The details shown in [Comment], [Driver], and [Port] vary depending on the operating system, printer model, and port.
10. **Click [Port], and then click [Add].**

11. Click [Standard TCP/IP Port], and then click [OK].

Configure the Standard TCP/IP port settings. See Windows Help if [Standard TCP/IP Port] does not appear.

12. Click [Next >] in the [Add Standard TCP/IP Printer Port Wizard] dialog box.**13. Enter the printer name or IP address in the [Printer Name or IP Address] box.**

The [Port Name] text box automatically obtains a port name. Change this name if necessary.

When the device selection appears, select "RICOH NetworkPrinter Driver C Model".

14. Click [Next >].**15. Click [Finish] in the [Add Standard TCP/IP Printer Port Wizard] dialog box.**

The installation start dialog box reappears.

16. Check that the port of the selected printer is displayed in [Port].**17. Configure the default printer as necessary.****18. Click [Continue].**

The printer driver installation starts.

19. After the installation is completed, select one of the options to restart the computer either now or later, and then click [Finish].

Restart the computer to complete the installation.

Note

- To stop installation of the selected driver, click [Cancel] before installation is complete.
- A message appears if there is a newer version of the printer driver already installed. If there is, you cannot install the printer driver using Auto Run. If you still want to install the printer driver, use [Add Printer]. See "Messages Displayed When Installing the Printer Driver".

Reference

- p.51 "Messages Displayed When Installing the Printer Driver"

Installing the PostScript 3 printer driver

1. Quit all applications currently running.**2. Insert the CD-ROM into the CD-ROM drive.**

The installer starts.

Auto Run may not work with certain operating system settings. If this happens, launch "Setup.exe" on the CD-ROM root directory.

3. Select an interface language, and then click [OK].

The default interface language is English.

The printer driver with the selected language will be installed. The English printer driver is installed when the following language is selected: Suomi, Magyar, Cestina, Polski, Portugues, Russian.

4. Click [PostScript 3 Printer Driver].

Add Printer Wizard starts.

Step 5 does not apply for Windows Vista users.

5. Click [Next >].

6. Click [Local printer] or [Local printer attached to this computer], and then click [Next >].

If you are using Windows Vista, you do not need to click [Next >].

7. Click [Create a new port:].

8. Click [Standard TCP/IP Port], and then click [Next >].

If you are using other than Windows 2000, [Standard TCP/IP Port] in [Create a new port].

9. Click [Next >] in the [Add Standard TCP/IP Printer Port Wizard] dialog box.

10. Enter the printer name or IP address in the [Printer Name or IP Address] box.

The [Port Name] text box automatically obtains a port name. Change this name if necessary.

When screen for Device selection appears, select "RICOH NetworkPrinter Driver C Model".

11. Click [Next >].

12. Click [Finish] in the [Add Standard TCP/IP Printer Port Wizard] dialog box.

13. Check that the name of the printer whose driver you want to install is selected, and then click [Next >].

14. Change the printer name if you want, and then click [Next >].

Select the [Yes] check box to configure the printer as default.

Step 15 does not apply for other than Windows 2000 users.

15. Specify whether or not to print a test page.

16. Click [Next >].

17. Specify whether or not to share the printer, and then click [Next >].

18. Specify whether or not to print a test page.

If you are using other than Windows Vista, click [Next >].

19. Click [Finish].

The printer driver installation starts.

Note

- To stop installation of the selected driver, click [Cancel] before installation is complete.
- A message appears if there is a newer version of the printer driver already installed. If there is, you cannot install the printer driver using Auto Run. If you still want to install the printer driver, use [Add Printer]. See "Messages Displayed When Installing the Printer Driver".

Reference

- p.51 "Messages Displayed When Installing the Printer Driver"

Using the IPP Port

This describes how to install the PCL printer driver using the IPP port.

Important

- **Manage Printers** permission is required to install the driver. Log on as an Administrators group member.
- In an IPv6 environment, you cannot use the IPP Port. Use the SmartDeviceMonitor for Client port.
- The IPP port cannot be used under Windows 2000. If you are using Windows 2000, install the printer driver using the SmartDeviceMonitor for Client port. To use the SmartDeviceMonitor for Client port, you must first download SmartDeviceMonitor for Client from the manufacturer's Web site. For details about the SmartDeviceMonitor for Client port, see "Using the SmartDeviceMonitor for Client Port".
- Installation of the certificate is especially necessary for users who want to print via IPP-SSL from Windows Vista or Windows Server 2008. For details, consult your administrator.
- If a certificate authority issues a certificate that must be authenticated by an intermediate certificate authority, and the certificate is installed on this machine, an intermediate certificate must be installed on the client computer. Otherwise, validation by the certificate authority will not be performed correctly. If validation cannot be performed properly, a warning message informing you that installation is not possible might appear when you try to add a printer using IPP-SSL under Windows Vista or Windows Server 2008. To enable authentication from the client computer, install the intermediate certificate on the client computer, and then reestablish connection.
- Intermediate certificates cannot be installed on this machine.

Reference

- p.20 "Using the SmartDeviceMonitor for Client Port"

Installing the PCL printer driver

1. Quit all applications currently running.
2. On the [Start] menu, click [Printers and Faxes].
3. Click [Add a printer].
The [Add printer Wizard] dialog box appears.
4. Click [Next >].
5. Click [A network printer, or a printer attached to another computer].
6. Click [Next >].
7. Click [Connect to a printer on the Internet or on a home or official network:].

8. In the [URL:] box, enter "http://printer's IP address/printer (or ipp)" as the printer's address, and then click [Next >].

9. Click [Have Disk...].

10. Insert the provided CD-ROM into the computer's CD-ROM drive.

If the [AutoPlay] dialog box appears, click the [close] button.

11. Click [Browse...], and then specify a location for the inf file.

If the CD-ROM drive letter is D, the printer driver's source files are stored in "D:\DRIVERS\ (PCL5E or PCL5C)\XP_VISTA\ (Language)\DISK1" or "D:\DRIVERS\PCL6\XP_VISTA\MUI\DISK1".

The PCL 6 printer driver is installed in the language specified by your operating system.

12. Click [OK] to close the [Install From Disk] window.

13. Select the printer you want to use, and then click [OK].

Only printers that respond to a broadcast from the computer appear. To use a printer not listed here, click [Specify Address], and then enter the IP address or host name of the printer.

14. Configure the default printer as necessary, and then click [Next >].

If the [Windows can't verify the publisher of this driver software] message appears, click [Install this driver software anyway].

15. Click [Finish].

If installation is successful, the icon of the printer connected to the IPP port is added to the [Printers and Faxes] window.

 **Note**

- To stop installation of the selected driver, click [Cancel] before installation is complete.

Installing the PostScript 3 printer driver

1. Quit all applications currently running.

2. On the [Start] menu, click [Printers and Faxes].

3. Click [Add a printer].

The [Add printer Wizard] dialog box appears.

4. Click [Next >].

5. Click [A network printer, or a printer attached to another computer].

6. Click [Next >].

7. Click [Connect to a printer on the Internet or on a home or official network:].

8. In the [URL:] box, enter "http://printer's IP address/printer (or ipp)" as the printer's address, and then click [Next >].

9. Click [Have Disk...].

10. Insert the provided CD-ROM into the computer's CD-ROM drive.

If the [AutoPlay] dialog box appears, click the [close] button.

11. Click [Browse...], and then specify a location for the inf file.

If the CD-ROM drive letter is D, the printer driver's source files are stored in "D:\DRIVERS\PS\nXP_VISTA\(\Language)\DISK1".

12. Click [OK] to close the Install From Disk window.**13. Select the printer you want to use, and then click [OK].**

Only printers that respond to a broadcast from the computer appear. To use a printer not listed here, click [Specify Address], and then enter the IP address or host name of the printer.

14. Configure the default printer as necessary, and then click [Next >].

If the [Windows can't verify the publisher of this driver software] message appears, click [Install this driver software anyway].

15. Click [Finish].

If installation is successful, the icon of the printer connected to the IPP port is added to the [Printers and Faxes] window.

Note

- To stop installation of the selected driver, click [Cancel] before installation is complete.

Using the LPR Port

This describes how to install the PCL or PostScript 3 printer drivers using the LPR port.

Important

- **Manage Printers permission is required to install the driver. Log on as an Administrators group member.**
- **In an IPv6 environment, you cannot use the LPR Port. Use the SmartDeviceMonitor for Client port.**

Installing the PCL printer driver

- 1. Quit all applications currently running.**
- 2. Insert the CD-ROM into the CD-ROM drive.**

The installer starts.

Auto Run may not work with certain operating system settings. If this happens, launch "Setup.exe" on the CD-ROM root directory.

- 3. Select an interface language, and then click [OK].**

The default interface language is English.

- 4. Click [PCL Printer Driver].**

5. The software license agreement appears in the [License Agreement] dialog box.

After reading the agreement, click [I accept the agreement.], and then click [Next >].

6. Select a printer driver you want to use in the [Select Program] dialog box.

You can select several printer drivers.

The PCL 6 printer driver is installed in the language specified by your operating system.

7. Select the printer model you want to use.

The printer name can be changed in the [Change settings for 'Printer Name'] box.

8. Click [Next >].

9. Double-click the printer name to display the printer settings.

The details shown in [Comment], [Driver], and [Port] vary depending on the operating system, printer model, and port.

10. Click [Port], and then click [Add].

11. Click [LPR Port], and then click [OK].

If [LPR Port] does not appear, see Windows Help and install it.

12. Enter the printer's IP address in the [Name or address of server providing lpd] box.

13. Enter "lp" in the [Name of printer or print queue on that server] box, and then click [OK].

The port is added.

14. Check that the port of the selected printer is displayed in [Port].

15. Configure the default printer as necessary.

16. Click [Continue].

The printer driver installation starts.

17. After the installation is completed, select one of the options to restart the computer either now or later, and then click [Finish].

Restart the computer to complete the installation.



Note

- To stop installation of the selected driver, click [Cancel] before installation is complete.
- A message appears if there is a newer version of the printer driver already installed. If there is, you cannot install the printer driver using Auto Run. If you still want to install the printer driver, use [Add Printer]. See "Messages Displayed When Installing the Printer Driver".



Reference

- p.51 "Messages Displayed When Installing the Printer Driver"

Installing the PostScript 3 printer driver

1. **Quit all applications currently running.**
2. **Insert the CD-ROM into the CD-ROM drive.**

The installer starts.

Auto Run may not work with certain operating system settings. If this happens, launch "Setup.exe" on the CD-ROM root directory.

3. **Select an interface language, and then click [OK].**

The default interface language is English.

The printer driver with the selected language will be installed. The English printer driver is installed when the following language is selected: Suomi, Magyar, Cestina, Polski, Portugues, Russian.

4. **Click [PostScript 3 Printer Driver].**

Add Printer Wizard starts.

Step 5 does not apply for Windows Vista users.

5. **Click [Next >].**

6. **Click [Local printer] or [Local Printer attached to this computer], and then click [Next >].**

If you are using Windows Vista, you do not need to click [Next >].

7. **Click [Create a new port:].**

8. **Click [LPR Port], and then click [Next >].**

If you are using other than Windows 2000, [Standard TCP/IP Port] in [Create a new port].

9. **Enter the printer's IP address in the [Name or address of server providing lpd] box.**

10. **Enter "lp" in the [Name of printer or print queue on that server box], and then click [OK].**

11. **Check that the name of the printer whose driver you want to install is selected, and then click [Next >].**

12. **Change the printer name if you want, and then click [Next >].**

Select the [Yes] check box to configure the printer as default.

Step 13 does not apply for Windows Vista users.

13. **Specify whether or not to share the printer, and then click [Next >].**

14. **Specify whether or not to print a test page.**

If you are using other than Windows Vista, click [Next >].

15. **Click [Finish].**

The printer driver installation starts.

↓ Note

- To stop installation of the selected software, click [Cancel] before the installation is complete.

- A message appears if there is a newer version of the printer driver already installed. If there is, you cannot install the printer driver using Auto Run. If you still want to install the printer driver, use [Add Printer]. See "Messages Displayed When Installing the Printer Driver".

Reference

- p.51 "Messages Displayed When Installing the Printer Driver"

2

Using the WSD Port

This describes how to install the PCL 5e/5c/6 or PostScript 3 printer drivers using the WSD port.

Important

- The WSD port can be used only under Windows Vista and Windows Server 2008.
- Manage Printers permission is required to install the driver. Log on as an Administrators group member.
- You can connect to the printer only if both the printer and computer are on the same network segment, or "Network discovery" is enabled. For details, see Windows Help.

Installing the PCL printer driver

1. Quit all applications currently running.
2. On the [Start] menu, click [Network].
The [Network] window appears, and the device search begins automatically.
3. Right-click the printer's icon, and then click [Install].
If the [User Account Control] dialog box appears, click [Continue].
The [Found New Hardware] dialog box appears.
4. Click [Locate and install driver software (Recommended)].
If the [User Account Control] dialog box appears, click [Continue].
5. Click [Don't search online].
6. Click [Browse my computer for driver software (advanced)].
7. Insert the provided CD-ROM into the computer's CD-ROM drive.
If the [AutoPlay] dialog box appears, click the [close] button and then proceed to step 8.
8. Click [Browse...], and then specify a location for the printer driver.
If the CD-ROM drive letter is D, the printer driver's source files are stored in "D: \DRIVERS\ (PCL6, PCL5E, or PCL5C) \XP_VISTA \MUI or (Language) \DISK1".
9. Click [Next].
If the [Windows can't verify the publisher of this driver software] message appears, click [Install this driver software anyway].

10. Click [Close].

If installation is successful, the icon of the printer connected to the "WSD" port is added to the [Printers] window.

Note

- The port name that follows "WSD" uses random character strings. It cannot be changed freely.
- To stop the installation, click [Cancel] before the installation is complete. When re-installing the WSD Port, right-click the printer's icon in the [Network] window, and then click [Uninstall].

Installing the PostScript 3 printer driver**1. Quit all applications currently running.****2. Click [Start], and then click [Network].**

The [Network] window appears, and the device search begins automatically.

3. Right-click the printer's icon, and then click [Install].

If the [User Account Control] dialog box appears, click [Continue].

The [Found New Hardware] dialog box appears.

4. Click [Locate and install driver software (recommended)].

If the [User Account Control] dialog box appears, click [Continue].

The [Found New Hardware] window appears.

5. Click [Don't search online].**6. Click [Browse my computer for driver software (advanced)].****7. Insert the provided CD-ROM into the computer's CD-ROM drive.**

If the [AutoPlay] dialog box appears, click the [close] button and then proceed to step 8.

8. Click [Browse...], and then specify a location for the printer driver.

If the CD-ROM drive letter is D, the printer driver's source files are stored in "D:\DRIVERS\PS\XP_VISTA\(\Language)\DISK1".

9. Click [Next].

If the [Windows can't verify the publisher of this driver software] message appears, click [Install this driver software anyway].

10. Click [Close].

If installation is successful, the icon of the printer connected to the "WSD" port is added to the [Printers] window.

Note

- The port name that follows "WSD" uses random character strings. It cannot be changed freely.

- To stop the installation, click [Cancel] before the installation is complete. When re-installing the WSD Port, right-click the printer's icon in the [Network] window, and then click [Uninstall].

Using the SmartDeviceMonitor for Client Port

2

This describes how to install the printer driver using the SmartDeviceMonitor for Client port.

To use this function, you must first download SmartDeviceMonitor for Client from the manufacturer's Web site and install it on your computer. Contact your local dealer for information on downloading SmartDeviceMonitor for Client.

★ Important

- **Manage Printers permission is required to install the driver. Log on as an Administrators group member.**

Installing the PCL printer driver (TCP/IP)

1. **Quit all applications currently running.**
2. **Insert the CD-ROM into the CD-ROM drive.**

The installer starts.

Auto Run may not work with certain operating system settings. If this happens, launch "Setup.exe" on the CD-ROM root directory.
3. **Select an interface language, and then click [OK].**

The default interface language is English.
4. **Click [PCL Printer Driver].**
5. **The software license agreement appears in the [License Agreement] dialog box.**

After reading the agreement, click [I accept the agreement.], and then click [Next >].
6. **Select the printer driver you want to use in the [Select Program] dialog box.**

You can select several printer drivers.

The PCL 6 printer driver is installed in the language specified by your operating system.
7. **Click [Next >].**
8. **Select the printer model you want to use.**

The printer name can be changed in the [Change settings for 'Printer Name'] box.
9. **Double-click the printer name to display the printer settings.**

The details shown in [Comment], [Driver], and [Port] vary depending on the operating system, printer model, and port.
10. **Click [Port], and then click [Add].**
11. **Click [SmartDeviceMonitor], and then click [OK].**

12. Click [TCP/IP], and then click [Search].

A list of printers using TCP/IP appears.

13. Select the printer you want to use, and then click [OK].

Only printers that respond to a broadcast from the computer appear. To use a printer not listed here, click [Specify Address], and then enter the IP address or host name of the printer.

14. Check that the port of the selected printer is displayed in [Port].**15. Set a user code, if necessary.**

Up to 8 numeric characters can be entered. No alphabetic characters or symbols can be entered.

16. Select the [Default Printer] check box to configure the printer as default.**17. Click [Continue].**

Installation starts.

18. After the installation is completed, select one of the options to restart the computer either now or later, and then click [Finish].**Note**

- To stop installation of the selected software, click [Cancel] before the installation is complete.
- A message appears if there is a newer version of the printer driver already installed. If there is, you cannot install the printer driver using Auto Run. If you still want to install the printer driver, use [Add Printer]. See "Messages Displayed When Installing the Printer Driver".
- A user code can be set after the printer driver installation. For information about user code, see the printer driver Help.

Reference

- p.51 "Messages Displayed When Installing the Printer Driver"

Installing the PostScript 3 printer driver (TCP/IP)**1. Quit all applications currently running.****2. Insert the CD-ROM into the CD-ROM drive.**

The installer starts.

Auto Run may not work with certain operating system settings. If this happens, launch "Setup.exe" on the CD-ROM root directory.

3. Select an interface language, and then click [OK].

The default interface language is English.

The printer driver with the selected language will be installed. The English printer driver is installed when the following language is selected: Suomi, Magyar, Cestina, Polski, Portugues, Russian.

4. Click [PostScript 3 Printer Driver].

Add Printer Wizard starts.

Step 5 does not apply for Windows Vista users.

5. Click [Next >].

6. Click [Local printer] or [Local printer attached to this computer.], and then click [Next >].

If you are using Windows Vista, you do not need to click [Next >].

7. Click [Create a new port:].

8. Click [SmartDeviceMonitor], and then click [Next >].

9. Click [TCP/IP], and then click [Search].

A list of printers using TCP/IP appears.

10. Select the printer you want to use, and then click [OK].

Only printers that respond to a broadcast from the computer appear. To use a printer not listed here, click [Specify Address], and then enter the IP address or host name of the printer.

11. Check that the name of the printer whose driver you want to install is selected, and then click [Next >].

12. Change the printer name if you want, and then click [Next >].

Select the [Yes] check box to configure the printer as default.

Step 13 does not apply for Windows Vista users.

13. Specify whether or not to share the printer, and then click [Next >].

14. Specify whether or not to print a test page.

If you are using other than Windows Vista, click [Next >].

15. Click [Finish].

The printer driver installation starts.

Note

- To stop installation of the selected software, click [Cancel] before the installation is complete.
- A message appears if there is a newer version of the printer driver already installed. If there is, you cannot install the printer driver using Auto Run. If you still want to install the printer driver, use [Add Printer]. See "Messages Displayed When Installing the Printer Driver".
- A user code can be set after the printer driver installation. For information about user code, see the printer driver Help.

Reference

- p.51 "Messages Displayed When Installing the Printer Driver"

Installing the PCL printer driver (IPP)

1. **Quit all applications currently running.**
2. **Insert the CD-ROM into the CD-ROM drive.**

The installer starts.

Auto Run may not work with certain operating system settings. If this happens, launch "Setup.exe" on the CD-ROM root directory.

3. **Select an interface language, and then click [OK].**

The default interface language is English.

4. **Click [PCL Printer Driver].**
5. **The software license agreement appears in the [License Agreement] dialog box.**

After reading the agreement, click [I accept the agreement.], and then click [Next >].

6. **Select a printer driver you want to use in the [Select Program] dialog box.**

You can select several printer drivers.

The PCL 6 printer driver is installed in the language specified by your operating system.

7. **Select the printer model you want to use.**

The printer name can be changed in the [Change settings for 'Printer Name'] box.

8. **Double-click the printer name to display the printer settings.**

The details shown in [Comment], [Driver], and [Port] vary depending on the operating system, printer model, and port.

9. **Click [Port], and then click [Add].**

10. **Click [SmartDeviceMonitor], and then click [OK].**

11. **Click [IPP].**

12. **In the [Printer URL] box, enter "http://(printer's IP address/printer)" as the printer's address.**

If the server authentication is issued, to enable SSL (a protocol for encrypted communication), enter "https://printer's IP address/printer" (Internet Explorer 5.01, or a higher version must be installed). (example IP address: 192.168.15.16)

`http://192.168.15.16/printer`

`https://192.168.15.16/printer`

You can enter "http://printer's IP address/ipp" as the printer's address.

13. **Enter a name for identifying the printer in [IPP Port Name]. Use a name different from the one of any existing ports.**

If a name is not specified here, the address entered in the [Printer URL] box becomes the IPP port name.

14. Click [Detailed Settings] to make necessary settings.

For details about the settings, see SmartDeviceMonitor for Client Help.

15. Click [OK].

16. Check that the port of the selected printer is displayed in [Port].

17. Set a user code, if necessary.

Up to 8 numeric characters can be entered. No alphabetic characters or symbols can be entered.

18. Select the [Default Printer] check box to configure the printer as default.

19. Click [Continue].

Installation starts.

20. After the installation is completed, select one of the options to restart the computer either now or later, and then click [Finish].

Restart the computer to complete the installation.

Note

- To stop installation of the selected software, click [Cancel] before the installation is complete.
- A message appears if there is a newer version of the printer driver already installed. If there is, you cannot install the printer driver using Auto Run. If you still want to install the printer driver, use [Add Printer]. See "Messages Displayed When Installing the Printer Driver".

Reference

- p.51 "Messages Displayed When Installing the Printer Driver"

Installing the PostScript 3 printer driver (IPP)

1. Quit all applications currently running.

2. Insert the CD-ROM into the CD-ROM drive.

The installer starts.

Auto Run may not work with certain operating system settings. If this happens, launch "Setup.exe" on the CD-ROM root directory.

3. Select an interface language, and then click [OK].

The default interface language is English.

The printer driver with the selected language will be installed. The English printer driver is installed when the following language is selected: Suomi, Magyar, Cestina, Polski, Portugues, Russian.

4. Click [PostScript 3 Printer Driver].

Add Printer Wizard starts.

Step 5 does not apply for Windows Vista users.

5. Click [Next >].

6. Click **[Local printer attached to this computer.]**, and then click **[Next >]**.

If you are using Windows Vista, you do not need to click **[Next >]**.

7. Click **[Create a new port:]**.

8. Click **[SmartDeviceMonitor]**, and then click **[Next >]**.

9. Click **[IPP]**.

10. In the **[Printer URL]** box, enter "**http://(printer's IP address or host name)/printer**" as the printer's address.

If the server authentication is issued, to enable SSL (a protocol for encrypted communication), enter "**https://(printer's IP address or host name)/printer**" (Internet Explorer 5.01, or a higher version must be installed).

(example IP address: 192.168.15.16)

`http://192.168.15.16/printer`

`https://192.168.15.16/printer`

You can enter "**http://printer's IP address or host name/ipp**" as the printer's address.

If the address is "192.168.001.010", you must enter it as "192.168.1.10" to connect to the printer.

11. Enter a name for identifying the printer in **[IPP Port Name]**. Use a name different from the one of any existing port.

If a name is not specified here, the address entered in the **[Printer URL]** box becomes the IPP port name.

12. Click **[Detailed Settings]** to make necessary settings.

If you are using Windows 2000, click **[OK]** after making necessary settings.

For information about the settings, see SmartDeviceMonitor for Client Help.

13. Click **[OK]**.

14. Check that the name of the printer driver you want to install is selected, and then click **[Next >]**.

15. Change the name of the printer if you want, and then click **[Next >]**.

Select the **[Yes]** check box to configure the printer as default.

Step 17 does not apply for Windows Vista users.

16. Specify whether or not to share the printer, and then click **[Next >]**.

17. Specify whether or not to print a test page.

If you are using other than Windows Vista, click **[Next >]**.

18. Click **[Finish]**.

The printer driver installation starts.

Note

- To stop installation of the selected software, click [Cancel] before the installation is complete.
- A message appears if there is a newer version of the printer driver already installed. If there is, you cannot install the printer driver using Auto Run. If you still want to install the printer driver, use [Add Printer]. See "Messages Displayed When Installing the Printer Driver".

Reference

- p.51 "Messages Displayed When Installing the Printer Driver"

2

Changing the port settings for SmartDeviceMonitor for Client

Follow the procedure below to change the SmartDeviceMonitor for Client settings, such as TCP/IP timeout, recovery/parallel printing, and printer groups.

Windows 2000:

1. On the [Start] menu, point to [Settings], and then click [Printers].

The [Printers] window appears.

2. Click the icon of the printer you want to use. On the [File] menu, click [Properties].

3. On the [Ports] tab, click [Configure Port].

The [Configuration] dialog box appears.

Windows XP, Windows Server 2003/2003 R2:

1. On the [Start] menu, click [Printers and Faxes].

The [Printers and Faxes] window appears.

2. Click the icon of the printer you want to use. On the [File] menu, click [Properties].

3. Click the [Ports] tab, and then click [Configure Port].

The [Port Configuration] dialog box appears.

Windows Vista, Windows Server 2008:

1. On the [Start] menu, click [Control Panel].

The [Control Panel] window appears.

2. Click [Printer].

The [Printers] window appears.

3. Right-click the icon of the printer you want to use, and then click [Properties].

4. Click the [Ports] tab, and then click [Configure Port].

The [Port Configuration:] dialog box appears.

Note

- User, proxy, and timeout settings can be configured for IPP.
- If no settings on the [Recovery/Parallel Printing] tab are available, follow the procedure below.
 1. Click [Cancel] to close the [Port Configuration:] dialog box.
 2. Start SmartDeviceMonitor for Client, and then right-click the SmartDeviceMonitor for Client icon on the task tray.
 3. Point to [Properties], and then click [Extended Features Settings].
 4. Select the Set [Recovery/Parallel Printing] for each port check box.
 5. Click [OK] to close the [Extended Features] dialog box.
- For details about these settings, see "Using SmartDeviceMonitor for Client port", or SmartDeviceMonitor for Client Help.

Reference

- p.20 "Using the SmartDeviceMonitor for Client Port"

Using as the Windows Network Printer

This describes how to install the PCL or PostScript 3 printer driver when using the printer as the Windows network printer.

To use the print server, install the printer driver by selecting "Network printer server", and then select the Windows 2000/XP/Vista, or Windows Server 2003/2003 R2/2008 shared printer.

This section assumes that the client has already been configured to communicate with a Windows 2000/XP/Vista, or Windows Server 2003/2003 R2/2008 print server. Do not begin the following procedure before the client is set up and configured correctly.

★ Important

- **Manage Printers permission is required to install the drivers. Log on as an Administrators group member.**
- **If you print with a print server connected to the printer using the SmartDeviceMonitor port, Recovery Printing and Parallel Printing cannot be used from the client.**
- **If you print under Windows XP/Vista or Windows Server 2003/2003 R2/2008 print server, notification functions of SmartDeviceMonitor may not be used with the client.**
- **If your operating system is Windows XP Pro x64, Windows Vista x64, or Windows Server 2003 x64/2003 R2 x64/2008 x64, you must download the printer driver from the manufacturer's Web site. Select this printer and the operating system you are using, and then download it.**

Installing the PCL printer driver

1. **Quit all applications currently running.**
2. **Insert the CD-ROM into the CD-ROM drive.**

The installer starts.

Auto Run may not work with certain operating system settings. If this happens, launch "Setup.exe" on the CD-ROM root directory.
3. **Select an interface language, and then click [OK].**

The default interface language is English.
4. **Click [PCL Printer Driver].**
5. **The software license agreement appears in the [License Agreement] dialog box.**

After reading the agreement, click [I accept the agreement.], and then click [Next >].
6. **Select the printer driver you want to use in the [Select Program] dialog box.**

You can select several printer drivers.

The PCL 6 printer driver is installed in the language specified by your operating system.
7. **Click [Next >].**

8. Select the [Printer Name] check box to select the printer models you want to use.

The printer name can be changed in the [Change settings for 'Printer Name'] box.

9. Double-click the printer name to display the printer settings.

The details shown in [Comment], [Driver], and [Port] vary depending on the operating system, printer model, and port.

10. Click [Port], and then click [Add].**11. Click [Network Printer], and then click [OK].****12. Double-click the computer name you want to use as the print server in the [Browse for Printer] window.****13. Select the printer you want to use, and then click [OK].****14. Check that the port of the selected printer is displayed in [Port].****15. Configure the user code as necessary.**

For details about user code, see the printer driver Help.

16. Select the [Default Printer] check box to configure the printer as default.**17. Click [Continue].**

The printer driver installation starts.

18. After the installation is completed, select one of the options to restart the computer either now or later, and then click [Finish].

Restart the computer to complete installation.

Note

- A user code can be set after the printer driver installation. For information about user code, see the printer driver Help.
- To stop installation of the selected software, click [Cancel] before the installation is complete.
- A message appears if there is a newer version of the printer driver already installed. If there is, you cannot install the printer driver using Auto Run. If you still want to install the printer driver, use [Add Printer]. See "Messages Displayed When Installing the Printer Driver".

Reference

- p.51 "Messages Displayed When Installing the Printer Driver"

Installing the PostScript 3 printer driver

1. Quit all applications currently running.**2. Insert the CD-ROM into the CD-ROM drive.**

The installer starts.

Auto Run may not work with certain operating system settings. If this happens, launch "Setup.exe" on the CD-ROM root directory.

3. Select an interface language, and then click [OK].

The default interface language is English.

The printer driver with the selected language will be installed. The English printer driver is installed when the following language is selected: Suomi, Magyar, Cestina, Polski, Portugues, Russian.

4. Click [PostScript 3 Printer Driver].

Add Printer Wizard starts.

Step 5 does not apply for Windows Vista users.

5. Click [Next >].

6. Click [Network printer] or [A network printer, or a printer attached to another computer].

If you are using other than Windows Vista, click [Next >].

7. Select [Browse for a printer], and then click [Next >].

If you are using Windows 2000, select the location method from the [Locate Your Printer] screen before clicking [Next >].

8. Double-click the computer name you want to use as the print server in the [Shared printers] window.

9. Select the printer you want to use, and then click [Next >].

10. The printer driver installation starts.

11. Click [Next >].

Select the [Yes] check box to configure the printer as default.

12. Click [Finish].

Restart the computer to complete installation.

Note

- A user code can be set after the printer driver installation. For information about user code, see the printer driver Help.
- To stop installation of the selected software, click [Cancel] before the installation is complete.
- A message appears if there is a newer version of the printer driver already installed. If there is, you cannot install the printer driver using Auto Run. If you still want to install the printer driver, use [Add Printer]. See "Messages Displayed When Installing the Printer Driver".

Reference

- p.51 "Messages Displayed When Installing the Printer Driver"

Using as the NetWare Print Server/Remote Printer

This describes how to set up the Windows computer used as the NetWare client.

★ Important

- Under Windows 2000/XP, and Windows Server 2003/2003 R2, Manage Printers permission is required to install the drivers. Log on as an Administrators group member.
- IPX/SPX (NetWare) cannot be used under Windows Vista and Windows Server 2008.
- In an IPv6 environment, NetWare servers cannot be used.

The following explanation assumes NetWare Client is installed on the client computer and the NetWare server environment is correctly set up. Install all necessary client applications before following this procedure.

Set up the printer driver while logging on to the NetWare file server.

The following values are used in the example:

- NetWare version: 4.1
- File server name: CAREE
- Queue name: R-QUEUE

1. Insert the CD-ROM into the CD-ROM drive.

The installer starts.

Auto Run may not work with certain operating system settings. In that case, launch "Setup.exe" on the CD-ROM root directory.

2. Select an interface language, and then click [OK].

The default interface language is English.

3. Click [PCL Printer Driver].

4. The software license agreement appears in the [License Agreement] dialog box.

After reading the agreement, click [I accept the agreement.], and then click [Next >].

5. Select the printer driver you want to use in the [Select Program] dialog box.

You can select several printer drivers.

The PCL 6 printer driver is installed in the language specified by your operating system.

6. Click [Next >].

7. Select the [Printer Name] check box to select the printer model you want to use.

The printer name can be changed in the [Change settings for 'Printer Name'] box.

8. Double-click the printer name to display the printer settings.

The details shown in [Comment], [Driver], and [Port] vary depending on the operating system, printer model, and port.

9. Click [Port], and then click [Add].

10. Click [Network Printer], and then click [OK].

11. Double-click the name of the NetWare file server on the network tree.

The created queue is displayed.

12. Select the print queue, and then click [OK].

13. Check that the port of the selected printer is displayed in [Port].

14. Click [Continue].

The printer driver installation starts.

15. Click [Finish] in the [Select Program] dialog box.

16. After the installation is completed, select one of the options to restart the computer either now or later, and then click [Finish].

Restart the computer to complete installation.

17. After restarting the computer, open the printer properties from the [Printers and Faxes] window.

Under Windows 2000 or Windows Server 2003/2003 R2, launch the [Printers] window, and then open the printer properties.

18. Click the [NetWare setting] tab.

Under Windows 2000 or Windows Server 2003/2003 R2, on the [Printer Settings] tab, clear the [Form Feed] and [Enable Banner] check boxes.

Do not select these check boxes since they are automatically selected by the printer driver. If you select the check boxes, the printer may not print correctly.

19. Click [OK] to close the printer properties dialog box.

Note

- To stop installation of the selected software, click [Cancel] before the installation is complete.
- The protocol is set to inactive as default. Enable it using SmartDeviceMonitor or Telnet.

When using the PostScript 3 Printer Driver

★ Important

- In an IPv6 environment, NetWare servers cannot be used.

Follow the procedure below to set up the PostScript 3 printer driver.

1. In the [Printers] or [Printers and Faxes] window, open the printer properties.
2. Click the [PostScript] tab.
When using Windows 2000/XP/Vista, and Windows Server 2003/2003 R2/2008, click the [Device Settings] tab, and then proceed to step to clear the check box.
3. Click [Advanced].
4. Clear the [Send CTRL+D before job] and [Send CTRL+D after job] check boxes, and then click [OK].
5. Click [OK] to close the printer properties dialog box.

Form Feed

Do not use NetWare to configure form feed. Form feed is controlled by the printer driver on Windows. If NetWare form feed is configured, the printer may not print properly.

Follow the procedure below to disable form feed according to the operating system used:

- Under Windows 2000/XP/Vista, or Windows Server 2003/2003 R2/2008, clear the [Form feed] check box on the [NetWare Settings] tab in the printer properties dialog box.

Banner Page

Do not use NetWare to configure a banner page.

Follow the procedure below to disable banner pages according to the operating system used:

- Under Windows 2000/XP/Vista, or Windows Server 2003/2003 R2/2008, clear the [Enable banner] check box on the [NetWare Settings] tab in the printer properties dialog box.

Printing after Resetting the Printer

Printer to print server connection requires 30 - 40 seconds to resume after the printer is reset. During this period, jobs may be accepted (depending on NetWare specifications) but not printed.

To print after resetting the printer as the remote printer, check on the print server that the remote printer is disconnected, or wait for two minutes before trying to print.

3. Local Connection

This chapter explains how to install the printer driver under Windows for through a local connected printer.

Installing the Printer Driver Using USB

This section explains how to install printer drivers using USB.

Before installing, check that only the operating system is running on the computer and no print jobs are in progress.

3

Windows 2000 - USB

★ Important

- **Manage Printers permission is required to install the drivers. Log on as an Administrators group member.**

If the printer driver has already been installed, and plug and play is enabled, the icon of the printer connected to the "USB" port is added to the [Printers] window.

If the printer driver is not installed, follow the plug-and-play instructions of the printer to install it from the CD-ROM provided with this printer.

1. **Check that the power of the printer is off.**
2. **Connect the printer to your computer with a USB cable.**

Connect the USB cable firmly.

3. **Turn on the power of the printer.**

Found New Hardware Wizard starts, and USB Printing Support is installed automatically.

4. **In the Found New Hardware Wizard window, click [Search for a suitable driver for my device [recommended]], and then click [Next >].**

5. **Select the [Specify location] check box, and then click [Next >].**

6. **Insert the CD-ROM in the CD-ROM drive.**

If Auto Run starts, click [Cancel] and then [Exit].

7. **Specify the location where the source files of the printer driver is stored.**

If the CD-ROM drive is D, the source files of the printer driver are stored in the following locations:

- PCL 5e
D:\DRIVERS\PCL5E\XP_VISTA\(\language)\disk 1
- PCL 5c
D:\DRIVERS\PCL5C\XP_VISTA\(\language)\disk 1

- PCL 6
D:\DRIVERS\PCL6\XP_VISTA\MUI\disk1
- PostScript 3
D:\DRIVERS\PS\XP_VISTA\(\language)\disk1

The PCL 6 printer driver is installed in the language specified by your operating system.

8. Check the printer driver location, and then click [OK].

9. Click [Next >].

10. Click [Finish].

If the installation is successful, the icon of the printer connected to the "USB001" port is added to the [Printers] window.

Note

- To disable Auto Run, press the left Shift key when inserting the CD-ROM into the drive and keep it pressed until the computer finishes reading from the CD-ROM.
- The number after "USB" varies depending on the number of printers connected.

Windows XP, Windows Server 2003/2003 R2 - USB

★ Important

- **Installing a printer driver requires Administrators permission. Log on using an account that has Administrators permission.**

If the printer driver has already been installed, plug and play is enabled, and the icon of the printer connected to the "USB" port is added to the [Printers] window.

If the printer driver is not installed, follow the plug-and-play instructions of the printer to install it from the CD-ROM provided.

- 1. Check that the power of the printer is off.**
- 2. Connect the printer to your computer with a USB cable.**
Connect the USB cable firmly.
- 3. Turn on the power of the printer.**
Found New Hardware Wizard starts, and USB Printing Support is installed automatically.
- 4. Click [No, not this time], and then click [Next >].**
- 5. In the Found New Hardware Wizard display, click [Install from a list or specific location [Advanced]], and then click [Next >].**
- 6. Insert the CD-ROM into the CD-ROM drive.**
If Auto Run starts, click [Cancel] and then [Exit].

7. Select the [Search removable media (floppy, CD-ROM...)] check box under [Search for the best driver in these locations], and then click [Next >].

8. Specify the location where the source files of the printer driver are stored.

If the CD-ROM drive is D, the source files of the printer driver are stored in the following locations:

- PCL 5e
D:\DRIVERS\PCL5E\XP_VISTA\{(language)\disk 1
- PCL 5c
D:\DRIVERS\PCL5C\XP_VISTA\{(language)\disk 1
- PCL 6
D:\DRIVERS\PCL6\XP_VISTA\MUI\disk 1
- PostScript 3
D:\DRIVERS\PS\XP_VISTA\{(language)\disk 1

The PCL 6 printer driver is installed in the language specified by your operating system.

9. Check the printer driver location, and then click [OK].

10. Click [Next >].

11. Click [Finish].

If the printer driver has already been installed, plug and play is enabled, and the icon of the printer connected to the "USB001" port is added to the [Printers] window.

Note

- To disable Auto Run, press the left Shift key when inserting the CD-ROM into the drive and keep it pressed until the computer finishes reading from the CD-ROM.
- The number after "USB" varies depending on the number of printers connected.

Windows Vista, Windows Server 2008 - USB

Important

- **Installing a printer driver requires Administrators permission. Log on using an account that has Administrators permission.**

If the printer driver has already been installed, plug and play is enabled, and the icon of the printer connected to the "USB" port is added to the [Printers] window.

The printer drivers can be installed from the CD-ROM provided with this printer.

If the printer driver is not installed, follow the plug-and-play instructions of the printer to install it from the CD-ROM provided.

1. Check that the power of the printer is off.

2. Connect the printer to your computer with a USB cable.

Connect the USB cable firmly.

3. Turn on the power of the printer.

Found New Hardware Wizard starts, and USB Printing Support is installed automatically.

4. In the Found New Hardware Wizard display, click [Search for a suitable driver for my device [recommended]], and then click [Next >].

5. Insert the CD-ROM into the CD-ROM drive.

If Auto Run starts, click [Cancel] and then [Exit].

6. Select the [Include this location in the search] check box under [Search for the best driver in these location], and then click [Browse] to select the printer driver location.

If the CD-ROM drive is D, the source files of the printer driver are stored in the following locations:

- PCL 5e
D:\DRIVERS\PCL5E\XP_VISTA\(\language)\disk 1
- PCL 5c
D:\DRIVERS\PCL5C\XP_VISTA\(\language)\disk 1
- PCL 6
D:\DRIVERS\PCL6\XP_VISTA\MUI\disk 1
- PostScript 3
D:\DRIVERS\PS\XP_VISTA\(\language)\disk 1

The PCL 6 printer driver is installed in the language specified by your operating system.

7. Check the printer driver location, and then click [Next >].

8. Click [Continue].

9. Click [Finish].

If the installation is successful, the icon of the printer connected to the "USB001" port is added to the [Printers and Faxes] window.

Note

- To disable Auto Run, press the left Shift key when inserting the CD-ROM into the drive and keep it pressed until the computer finishes reading from the CD-ROM.
- The number after "USB" varies depending on the number of printers connected.

Troubleshooting USB

Problem	Solutions
The printer is not recognized automatically.	Turn off the power of this printer, and then reconnect the USB cable. Make sure the cable is securely connected to the USB ports, and then turn on the power again.
Windows has already configured the USB settings.	<p>Open Windows' Device Manager, and then, under [Universal Serial Bus controllers], remove any conflicting devices. Conflicting devices have a [!] or [?] icon by them. Take care not to accidentally remove required devices. For details, see Windows Help.</p> <p>When using Windows 2000/XP or Windows Server 2003/2003 R2/2008, an erroneous device is displayed under [USB Controller] in the [Device Manager] dialog box.</p>

Installing the Printer Driver Using Parallel Cable

This describes how to install the PCL 5e/5c/6 or PostScript 3 printer driver when using a parallel port.

To use a printer connected using a parallel interface, click [LPT1] when installing the printer driver.

★ Important

- **Manage Printers permission is required to install the drivers. Log on as an Administrators group member.**

3

Installing the PCL Printer Driver

This describes how to install the PCL 5e/5c/6 printer driver when using a parallel port.

1. **Quit all applications currently running.**
2. **Insert the CD-ROM into the CD-ROM drive.**

The installer starts.

Auto Run may not work with certain operating system settings. If this happens, launch "Setup.exe" on the CD-ROM root directory.
3. **Select an interface language, and then click [OK].**

The default interface language is English.
4. **Click [PCL Printer Driver].**
5. **The software license agreement appears in the [License Agreement] dialog box.**

After reading the agreement, click [I accept the agreement.], and then click [Next >].
6. **Select the printer driver you want to use in the [Select Program] dialog box.**

You can select several printer drivers.

The PCL 6 printer driver is installed in the language specified by your operating system.
7. **Click [Next >].**
8. **Select the [Printer Name] check box to select the printer model you want to use.**

The printer name can be changed in the [Change settings for 'Printer Name'] box.
9. **Double-click the printer name to display the printer settings.**

The details shown in [Comment], [Driver], and [Port] vary depending on the operating system, printer model, and port.
10. **Check that [LPT1:] is shown in [Port].**
11. **Select the [Default Printer] check box to configure the printer as default.**
12. **Click [Finish].**

The printer driver installation starts.

- 13. After the installation is completed, select one of the options to restart the computer either now or later, and then click [Finish].**

Restart the computer to complete installation.

↓ Note

- To stop installation of the selected software, click [Cancel] before installation is complete.
- A user code can be set after the printer driver installation. For information about user code, see the printer driver Help.
- A message appears if there is a newer version of the printer driver already installed. If there is, you cannot install the printer driver using Auto Run. If you still want to install the printer driver, use [Add Printer]. See "Messages Displayed When Installing the Printer Driver".

📖 Reference

- p.51 "Messages Displayed When Installing the Printer Driver"

Installing the PostScript 3 Printer Driver

This describes how to install the PostScript 3 printer driver when using a parallel port.

Windows 2000

- 1. Quit all applications currently running.**
- 2. Insert the CD-ROM into the CD-ROM drive.**

The installer starts.

Auto Run may not work with certain operating system settings. If this happens, launch "Setup.exe" on the CD-ROM root directory.

- 3. Select an interface language, and then click [OK].**
- 4. Click [PostScript 3 Printer Driver].**

Add Printer Wizard starts.

- 5. Click [Next >].**
- 6. Click [Local printer], and then click [Next >].**

A dialog box for selecting the printer manufacturer and model name appears.

- 7. Select [LPT1] at the [Printer Port] dialog box, and then click [Next >].**
- 8. Select whether or not to share the printer, and then click [Next >].**
- 9. Select the name of the printer whose driver you want to install, and then click [Next >].**
- 10. Select whether or not you want to print a test page, and then click [Finish].**

The printer driver installation starts.

11. Restart the computer to complete installation if necessary.

↓ Note

- To stop installation of the selected software, click [Cancel] before installation is complete.
- A user code can be set after the printer driver installation. For information about user code, see the printer driver Help.
- A message appears if there is a newer version of the printer driver already installed. If there is, you cannot install the printer driver using Auto Run. If you still want to install the printer driver, use [Add Printer]. See "Messages Displayed When Installing the Printer Driver".

📖 Reference

- p.51 "Messages Displayed When Installing the Printer Driver"

Windows XP, Windows Server 2003/2003 R2

1. Quit all applications currently running.

2. Insert the CD-ROM into the CD-ROM drive.

The installer starts.

Auto Run may not work with certain operating system settings. If this happens, launch "Setup.exe" on the CD-ROM root directory.

3. Select an interface language, and then click [OK].

4. Click [PostScript 3 Printer Driver].

Add Printer Wizard starts.

5. Click [Next >].

6. Click [Local printer attached to this computer], and then click [Next >].

7. Select the port you want to use, and then click [Next >].

A dialog box for selecting the printer manufacturer and model name appears.

8. Select the name of the printer whose driver you want to install, and then click [Next >].

9. Click [Close] to close the [Printer Port] dialog box.

10. Click [Next >].

11. Change the printer name if you want, and then click [Next >].

12. Select whether or not to share the printer, and then click [Next >].

13. Specify whether or not to print a test page, and then click [Finish].

The printer driver installation starts.

14. Restart the computer to complete installation.

Note

- To stop installation of the selected software, click [Cancel] before installation is complete.
- A user code can be set after the printer driver installation. For information about user code, see the printer driver Help.
- A message appears if there is a newer version of the printer driver already installed. If there is, you cannot install the printer driver using Auto Run. If you still want to install the printer driver, use [Add Printer]. See "Messages Displayed When Installing the Printer Driver".

Reference

- p.51 "Messages Displayed When Installing the Printer Driver"

Windows Vista, Windows Server 2008

1. **Quit all applications currently running.**
2. **Insert the CD-ROM into the CD-ROM drive.**

The installer starts.

Auto Run may not work with certain operating system settings. If this happens, launch "Setup.exe" on the CD-ROM root directory. If the [User Account Control] dialog box appears, click [Continue] to allow the auto play program to run.

3. **Select an interface language, and then click [OK].**
4. **Click [PostScript 3 Printer Driver].**

Add Printer Wizard starts.
5. **Click [Add a local printer].**
6. **Select the port you want to use, and then click [Next >].**

A dialog box for selecting the printer manufacturer and model name appears.
7. **Select the name of the printer whose driver you want to install, and then click [Next >].**
8. **Change the printer name if you want, and then click [Next >].**

Select the check box to configure the printer as default.
9. **Specify whether or not to share the printer, and then click [Next >].**
10. **Specify whether or not to print a test page, and then click [Finish].**

The printer driver installation starts.

Restart the computer to complete installation.

Note

- To stop installation of the selected software, click [Cancel] before installation is complete.
- A user code can be set after the printer driver installation. For information about user code, see the printer driver Help.

- A message appears if there is a newer version of the printer driver already installed. If there is, you cannot install the printer driver using Auto Run. If you still want to install the printer driver, use [Add Printer]. See "Messages Displayed When Installing the Printer Driver".

Reference

- p.51 "Messages Displayed When Installing the Printer Driver"

4. When Using the Printer under Mac OS

This chapter explains how to install and configure the printer drivers for use on the Mac OS X operating system.

Installing the Printer

This section explains how to configure a Mac OS X to use EtherTalk, USB, and TCP/IP.

Follow the procedure below to configure Mac OS X 10.3.8. If you are not using Mac OS X 10.3.8, see the manual of the Mac OS X you are using for details.

★ Important

- Mac OS X 10.2 or higher is required.

↓ Note

- The PPD files are stored in the following folder on the CD-ROM.
Mac OS X: MacOSX PPD Installer
- If you want to use AppleTalk, use the control panel or Web Image Monitor to enable AppleTalk. (The default is **Inactive**.)

Installing the PPD Files

Follow the procedure below to install a PPD file to print from Mac OS X.

★ Important

- You need an administrator name and a password (phrase). For details, consult your administrator.
1. Insert the CD-ROM into the CD-ROM drive.
 2. Double-click the CD-ROM drive icon.
 3. Double-click the [Mac OS X] folder.
 4. Double-click the [MacOSX PPD Installer] folder.
 5. Double-click the [MAC OSX 10.1 or later] or [MAC OSX 10.5 or later] folder, depending on your operating system.
 6. Double-click the [MacOSX PPD Installer] folder.
 7. Double-click the package file icon.
 8. Follow the instructions on the screen.

Setting Up the PPD File

1. Start Printer Setup Utility.

Under Mac OS X 10.5 or 10.6, start System Preferences and click [Print & FAX].

2. Click [Add] or [+] button.

Mac OS X 10.5 or 10.6

Click [Default]. If the printer name is not displayed, select the icon that corresponds to your network environment (AppleTalk, etc.).

If several AppleTalk zones exist on the network, select the zone the printer belongs to.

Mac OS X 10.4

Click [More Printers...]. Then select the zone from the second pop-up menu.

Mac OS X 10.3 or lower

Click [AppleTalk] on the first pop-up menu.

If the zone is set, select the zone from the second pop-up menu.

3. Select the printer, and then select its manufacturer from the [Printer Model:] pop-up menu.

Under Mac OS X 10.4, select the printer you are using from the [Print Using] popup menu.

Under Mac OS X 10.5 or 10.6, select the printer you are using from the [Printer Name] list.

4. Select the PPD file for the model you are using, and then click [Add].

5. Quit Printer Setup Utility or System Preferences.

Setting Up Options for Mac OS X

This section explains how to configure the printer driver.

1. Start System Preferences.

2. Click [Utilities], and then double-click [Print Center] or [Printer Setup Utility].

Mac OS X 10.5 or 10.6

Click [Print & Fax].

The printer list dialog box appears.

3. Select the printer you are using, and then click [Show Info].

Mac OS X 10.5 or 10.6

Select the printer you are using, and then click [Options & Supplies...].

4. Select [Installable Options] in the drop-down menu, and then configure settings as needed.

Mac OS X 10.5 or 10.6

Click [Driver], and then configure settings as needed.

5. Click **[Apply Changes]**.

Mac OS X 10.5 or 10.6

Click **[OK]**.

Note

- If the option you want to select is not displayed, PPD files may not be set up correctly. To complete the setup, check the name of the PPD file displayed in the dialog box.

Using USB Interface

Follow the procedure below to setup USB connection.

Important

- **USB2.0 can be used only with Mac OS X 10.3.3 or higher.**

1. Start Printer Setup Utility.

Under Mac OS X 10.5 or 10.6, start System Preferences and click **[Print & FAX]**.

2. Click **[Add] or **[+]** button.**

Mac OS X 10.5 or 10.6

Click **[Default]**.

Mac OS X 10.4

Click a printer that has "USB" indicated in the "Connection" column.

Mac OS X 10.3 or lower

Click **[USB]** on the pop-up menu.

The connected printer appears.

3. Select the printer, and then select its manufacturer from the **[Printer Model:] pop-up menu.**

Under Mac OS X 10.4, select the printer you are using from the **[Print Using]** pop-up menu.

A list of printer types appears.

Under Mac OS X 10.5 or 10.6, select the printer you are using from the **[Printer Name]** list, and **[kind]** of USB.

4. Select the connected printer from the list of printer models, and then click **[Add].**

5. Quit Printer Setup Utility or System Preferences.

Note

- When printing with a USB connection to a Macintosh computer, printer language does not change automatically. Use the control panel on this printer to change printer language to **[Auto Detect]** or **[PS]** before printing.

Using Bonjour

Follow the procedure below to print using Bonjour under Mac OS X 10.2.3 or higher. Ethernet, wireless LAN connections can also be used.

1. Start [Printer Setup Utility].

Under Mac OS X 10.5 or 10.6, start System Preferences and click [Print & FAX].

2. Click [Add] or [+] button.

Mac OS X 10.5 or 10.6

Click [Default].

If several AppleTalk zones exist on the network, select the zone the printer belongs to.

Mac OS X 10.4

Click a printer that has "Bonjour" indicated in the "Connection" column.

Mac OS X 10.3 or lower

Click [Rendezvous] on the pop-up menu.

3. Select the name of the connected printer from the list of printer models, and then click [Add].

Under Mac OS X 10.4, Installable Options window appears. Select the option you want to set up, and then select an appropriate setting for it, and then [Continue].

Under Mac OS X 10.5 or 10.6, select the printer you are using from the [Printer Name] list, and [kind] of Bonjour.

4. Quit Printer Setup Utility or System Preferences.

Note

- When printing with a Bonjour connection to a Macintosh computer, printer language does not change automatically. Use the control panel on this printer to change printer language to [Auto Detect] or [PS] before printing.

Changing to EtherTalk

Follow the procedure below to configure a Mac OS X to use EtherTalk.

★ Important

- You need an administrator name and a password (phrase). For details, consult your administrator.

1. Open [System Preference], and then click the Network icon.

2. Click [Built-in Ethernet] or [Ethernet] in the list box.

Under Mac OS X 10.5 or 10.6, Click [Advanced...].

3. Click the [AppleTalk] tab.

4. Select the [Make AppleTalk Active] check box.
5. To change Apple Talk zones, select a name from the [AppleTalk Zone:] pop-up menu.
6. When the settings are made, click [Apply Now].

Mac OS X 10.5

Click [OK], and then click [Apply].

Note

- For information about installing applications required for EtherTalk, see the Mac OS manuals.

5. Appendix

Messages Displayed When Installing the Printer Driver

This section describes what to do if a message appears when installing the printer driver.

Message number 58 or 34 indicates that the printer driver cannot be installed using Auto Run. Install the printer driver using [Add Printer] or [Install Printer].

Message number 58 appears if there is a newer version of the printer driver already installed.

Windows 2000

This section describes the procedure under Windows 2000.

1. On the [Start] menu, point to [Settings], and then click [Printers].
2. Double-click the Add Printer icon.
3. Follow the instructions in Add Printer Wizard.

If the printer driver is on the CD-ROM, the location of the driver is \DRIVERS\{PCL6, PCL5C, PCL5E, or PS}\XP_VISTA\{language} or MUI\DISK1. If the installer starts, click [Cancel] to quit.

4. Specify a port.

Note

- Available ports vary according to your Windows operating system or the type of interface. For details, see "Network Connection" or "Local Connection".

Reference

- p.7 "Network Connection"
- p.35 "Local Connection"

Windows XP Professional or Windows Server 2003/2003 R2

This section describes the procedure under Windows XP Professional or Windows Server 2003/2003 R2.

1. On the [Start] menu, click [Printers and Faxes].
2. Click [Add a printer].

3. Follow the instructions in Add Printer Wizard.

If the printer driver is on the CD-ROM, the location of the driver is \DRIVERS\{PCL6, PCL5C, PCL5E, or PS}\XP_VISTA\{language} or MUI\DISK1. If the installer starts, click [Cancel] to quit.

4. Specify a port.

Note

- Available ports vary according to your Windows operating system or the type of interface. For details, see "Network Connection" or "Local Connection".

Reference

- p.7 "Network Connection"
- p.35 "Local Connection"

5

Windows XP Home Edition

This section describes the procedure under Windows XP Home Edition.

1. On the [Start] menu, click [Control Panel].
2. Click [Printer and Other Hardware].
3. Click [Printers and Faxes].
4. Click [Add a Printer].
5. Follow the instructions in Add Printer Wizard.

If the printer driver is on the CD-ROM, the location of the driver is \DRIVERS\{PCL6, PCL5C, PCL5E, or PS}\XP_VISTA\{language} or MUI\DISK1. If the installer starts, click [Cancel] to quit.

6. Specify a port.

Note

- Available ports vary according to your Windows operating system or the type of interface. For details, see "Network Connection" or "Local Connection".

Reference

- p.7 "Network Connection"
- p.35 "Local Connection"

Windows Vista, Windows Server 2008

This section describes the procedure under Windows Vista and Windows Server 2008.

1. On the [Start] menu, click [Control Panel].
2. Click [Hardware and Sound].

3. Click [Printers].**4. Click [Add a printer].****5. Follow the instructions in Add Printer Wizard.**

If the printer driver is on the CD-ROM, the location of the driver is \DRIVERS\{PCL6, PCL5C, PCL5E, or PS}\XP_VISTA\{language} or MUI\DISK1. If the installer starts, click [Cancel] to quit.

6. Specify a port.**Note**

- Available ports vary according to your Windows operating system or the type of interface. For details, see "Network Connection" or "Local Connection".

Reference

- p.7 "Network Connection"
- p.35 "Local Connection"

Making Option Settings for the Printer

When bidirectional communication works correctly, your computer obtains information about option, paper size and paper feed direction settings from the printer automatically. Bidirectional communication also allows you to monitor printer status.

When bidirectional communication is disabled, you have to set up option, paper size and paper feed direction settings on your computer manually.

Conditions for Bidirectional Communication

To support bidirectional communication, the following conditions must be met:

When connected with parallel cables

- The computer must support bidirectional communication.
- The printer must support bidirectional communication.
- The interface cable must support bidirectional communication.
- The printer must be connected to the computer using the standard parallel cables and parallel connectors.
- Under Windows 2000, [Enable bidirectional support] must be selected, and [Enable printer pooling] must not be selected on the [Ports] tab with the printer driver.

When connected with the network

- The printer must support bidirectional communication.
- The Standard TCP/IP port must be used.
- [Enable bidirectional support] must be selected, and [Enable printer pooling] must not be selected on the [Ports] tab with the printer driver.
- In addition to the above, one of the following conditions must also be met:
 - The TCP/IP protocol must be used.
 - IPP port name must include the IP address when using the IPP protocol.

When connected with USB

- The printer must be connected to the computer's USB port using the USB interface cable.
- The computer must support bidirectional communication.

Note

- The PCL 6 printer driver supports bidirectional communication and updates the printer status automatically.
- The PCL 5e/5c printer driver supports bidirectional communication. You can update the printer status manually.

If Bidirectional Communication Is Disabled

This section describes how to set up option, paper size and paper feed direction settings on your computer manually.

★ Important

- **Manage Printers permission is required to change the printer properties in the [Printers] folder. Log on as an Administrators group member.**

1. On the [Start] menu, click [Printers and Faxes].

When using Windows 2000, point to [Settings] on the [Start] menu, and then click [Printers]. The [Printers] window appears.

When using Windows Vista or Windows Server 2008, click [Control Panel] on the [start] menu, and then click [Printer]. The [Printers] window appears.

2. Click the icon of the printer you want to use.

3. On the [File] menu, click [Properties].

When using Windows Vista or Windows Server 2008, right-click the icon of the printer you want to use, and then click the [Properties].

4. Click the [Accessories] tab.

If options in the [Accessories] tab are disabled, bidirectional connection is enabled. In this case, no change is necessary for option settings.

5. Select options installed from the [Options] area, and then make the necessary settings.

6. In [Input Tray:] select which trays to use, and then, in [Paper Size:] select the size of the paper that you want to load in each tray.

Click [Update] in the [Input Tray Settings] area to apply the setting for each tray.

7. Click [OK] to close the printer properties dialog box.

Installing Font Manager

★ Important

- **Manage Printers permission is required to install Font Manager. Log on as an Administrators group member.**
1. **Quit all applications currently running.**
 2. **Insert the CD-ROM into the CD-ROM drive.**
The installer starts.
 3. **Click [Font Manager].**
 4. **Follow the instructions on the display.**

Using Adobe PageMaker Version 6.0, 6.5, or 7.0

Under Windows 2000/XP with Adobe PageMaker, you need to copy PPD files to the PageMaker folder. PPD files have the .ppd extension in the folder "DRIVERS \ PS \ XP_VISTA \ (Language) \ DISK1" on the CD-ROM.

The "XP_VISTA" folder inside the "PS" folder is for Windows 2000/XP, Windows Server 2003/2003 R2. Use the folder that is appropriate for the operating system you are currently using.

The third folder "(Language)" may be substituted by an appropriate language name.

Copy the .ppd file to the PageMaker folder.

- **For PageMaker 6.0 default installation**

The directory is "C:\PM6\RSRC\PPD4".

- **For PageMaker 6.5 default installation**

The directory is "C:\PM65\RSRC\USENGLISH\PPD4".

The "USENGLISH" may vary depending on your language selection.

- **For PageMaker 7.0 default installation**

The directory is "C:\PM7\RSRC\USENGLISH\PPD4".

The "USENGLISH" may vary depending on your language selection.

↓ Note

- If the driver is not set correctly after copying the ".ppd" file, printing may not be performed properly.
- When using PageMaker, the optional features that can be selected by the printer driver will not be active. The following procedure describes how to activate the optional printer features.

1. On the [File] menu, click [Print].
The [Print Document] dialog box appears.
2. Make the necessary settings in the [Features] box.

Trademarks

Adobe, PageMaker, and PostScript are either registered trademarks or trademarks of Adobe Systems Incorporated in the United States and/or countries.

Apple, AppleTalk, EtherTalk, Macintosh, and Mac OS are registered trademarks of Apple Inc, registered in the U.S. and other countries.

IPS is a trademark or registered trademark of Zoran Corporation and/or its subsidiaries in the United States or other countries.

Microsoft[®], Windows[®], Windows Server[®], and Windows Vista[®] are either registered trademarks or trademarks of Microsoft Corporation in the United States and/or other countries.

Monotype is a registered trademark of Monotype Imaging, Inc.

PCL[®] is a registered trademark of Hewlett-Packard Company.

5

Other product names used herein are for identification purposes only and might be trademarks of their respective companies. We disclaim any and all rights to those marks.

The proper names of the Windows operating systems are as follows:

*The product names of Windows 2000 are as follows:

Microsoft[®] Windows[®] 2000 Professional

Microsoft[®] Windows[®] 2000 Server

Microsoft[®] Windows[®] 2000 Advanced Server

Microsoft[®] Windows[®] 2000 Datacenter Server

*The product names of Windows XP are as follows:

Microsoft[®] Windows[®] XP Professional

Microsoft[®] Windows[®] XP Home Edition

Microsoft[®] Windows[®] XP Media Center Edition

Microsoft[®] Windows[®] XP Tablet PC Edition

Microsoft[®] Windows[®] XP Professional x 64 Edition

*The product names of Windows Vista are as follows:

Microsoft[®] Windows Vista[®] Ultimate

Microsoft[®] Windows Vista[®] Business

Microsoft[®] Windows Vista[®] Home Premium

Microsoft[®] Windows Vista[®] Home Basic

Microsoft[®] Windows Vista[®] Enterprise

*The product names of Windows Server 2003 are as follows:

Microsoft[®] Windows Server[®] 2003 Standard Edition

Microsoft® Windows Server® 2003 Enterprise Edition

Microsoft® Windows Server® 2003 Web Edition

Microsoft® Windows Server® 2003 Datacenter Edition

*The product names of Windows Server 2003 R2 are as follows:

Microsoft® Windows Server® 2003 R2 Standard Edition

Microsoft® Windows Server® 2003 R2 Enterprise Edition

Microsoft® Windows Server® 2003 R2 Datacenter Edition

*The product names of Windows Server 2008 are as follows:

Microsoft® Windows Server® 2008 Foundation

Microsoft® Windows Server® 2008 Standard

Microsoft® Windows Server® 2008 Enterprise

Microsoft® Windows Server® 2008 Datacenter

INDEX

A

Add printer wizard.....51, 52

B

Banner page.....33

Bidirectional communication.....54, 55

Bonjour.....48

C

Changing the port settings.....26

Connection method.....7

D

Download.....4

E

EtherTalk.....48

F

Font Manager.....56

Form feed.....33

H

How to read this manual.....3

I

IPP port.....13

L

LPR port.....15

M

Mac OS X.....45

Messages.....51

N

NetWare print server.....31

Network printer.....8

O

Option settings.....54

P

PageMaker.....57

Parallel cable.....40, 41

PCL printer driver.....10, 13, 15, 18, 20, 23, 28, 40

PostScript 3 printer driver....11, 14, 17, 19, 21, 24,
29, 32, 41

PPD files.....45, 46

Printer driver.....4

Printing port.....7

Q

Quick install.....5

R

Remote printer.....31

Resetting the printer.....33

S

Selected port.....10

Setting up options.....46

SmartDeviceMonitor for Client port.....20

Standard TCP/IP port.....10

T

Trademarks.....58

Troubleshooting USB.....39

U

USB.....35, 36, 37, 47

W

Windows network printer.....28

WSD port.....18

MEMO

MEMO

MEMO

Operating Instructions Driver Installation Guide





VM Card

Operating Instructions Extended Feature Settings Web Reference

-
- 1 Introduction
 - 2 Screens
 - 3 Startup Setting
 - 4 Extended Feature Info
 - 5 Install
 - 6 Uninstall
 - 7 Administrator Tools
 - 8 Appendix

TABLE OF CONTENTS

Notice.....	3
Important.....	3
How to Read This Manual.....	4
Symbols.....	4
Notes.....	4
About IP Address.....	4
1. Introduction	
What are Extended Features?.....	5
Types of Extended Features.....	5
This Manual.....	6
2. Screens	
Displaying the Operation Screen.....	7
Logging in as an Administrator.....	7
Web Image Monitor Operations Screens.....	9
Startup Setting Screen.....	9
Extended Feature Info Screen.....	11
Install Screen.....	12
Uninstall Screen.....	13
Administrator Tools Screen.....	15
Other Screens.....	16
3. Startup Setting	
Starting and Stopping Extended Features.....	21
Starting Extended Features.....	21
Stopping Extended Features.....	23
Setting Priority.....	25
4. Extended Feature Info	
Displaying Extended Feature Information.....	27
5. Install	
Installing Extended Features.....	29
6. Uninstall	
Uninstalling Extended Features.....	31

7. Administrator Tools

Setting Heap / Stack Size.....	33
Web Service Settings.....	35
Enabling/Disabling Communication Protocols.....	35

8. Appendix

Trademarks.....	37
INDEX	39

Notice

Important

In no event will the company be liable for direct, indirect, special, incidental, or consequential damages as a result of handling or operating the machine.

How to Read This Manual

Symbols

This manual uses the following symbols:

 **Important**

Indicates points to pay attention to when using the machine, and explanations of likely causes of paper misfeeds, damage to originals, or loss of data. Be sure to read these explanations.

 **Note**

Indicates supplementary explanations of the machine's functions, and instructions on resolving user errors.

 **Reference**

This symbol is located at the end of sections. It indicates where you can find further relevant information.

[]

Indicates the names of keys on the machine's display or control panels.

Notes

Contents of this manual are subject to change without prior notice.

Some illustrations in this manual might be slightly different from the machine.

Certain options might not be available in some countries. For details, please contact your local dealer.

Depending on which country you are in, certain units may be optional. For details, please contact your local dealer.

About IP Address

In this manual, "IP address" covers both IPv4 and IPv6 environments. Read the instructions that are relevant to the environment you are using.

1. Introduction

What are Extended Features?

"Extended features" are features (applications) that enable you use this device more easily.

The extended features installed on a device differ according to user's requirements. For details about which extended features are installed on your device, ask the device manager.

Types of Extended Features

Extended features are classified into two types, Type-J ^{*1}, and Type-C ^{*2}, depending on the development environment.

Type-J ^{*1} extended features

These are features (applications) that are developed using Java.

Type-C ^{*2} extended features

These are features (applications) that are developed using C language.

You can confirm which type of extended features are in use from the "Type" column of the list displayed in the operation screen of Web Image Monitor.

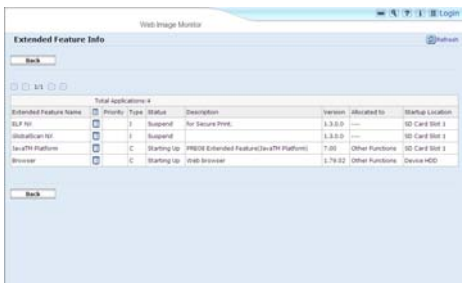

For details, see "Web Image Monitor Operations Screens".

^{*1} Embedded Software Architecture Application Java language version

^{*2} Embedded Software Architecture Application C language version

Reference

- p.9 "Web Image Monitor Operations Screens"

This Manual

This manual explains the [Startup Setting], [Extended Feature Info], [Install], [Uninstall], and [Administrator Tools] regarding extended features installed in your devices.

If operating methods differ according to the type of extended feature, separate descriptions are given.

↓ Note

- The [Additional Program Startup Setting], [Install Additional Program], [Uninstall Additional Program], [Copy Extended Features], and [Copy Card Save Data] of the Extended Feature Settings are not used and are therefore not explained in this manual. For information about these settings, consult your nearest sales or service representative.
- Confirm general extended feature operations with the administrator.

☰ Reference

- p.5 "Types of Extended Features"

2. Screens

Displaying the Operation Screen

Use the [Configuration] menu of Web Image Monitor to display the operation screen.

1. Activate the web browser.
2. In the address bar, enter `http://(IP address of device whose status you want to display)/` and press Enter key of the keyboard.

The initial screen of Web Image Monitor appears.

3. Click [Configuration] in the menu on the left side of Web Image Monitor screen.
The configuration menu is displayed on the right side of the screen.
4. "Extended Feature Settings", click the items you want to use.



Note

- For details about the settings you must make to use Web Image Monitor, see the Network and System Settings Reference or Software Guide.
- To set [Startup Setting], [Install], [Uninstall], or [Administrator Tools], you must login as an administrator. For details, see "Logging in as an Administrator".

Reference

- p.7 "Logging in as an Administrator"

Logging in as an Administrator

To set [Startup Setting], [Install], [Uninstall], or [Administrator Tools], you must login as an administrator. Enter a login user name and login password, and then log in.

1. Click [Login] in the upper right-hand corner of Web Image Monitor initial screen.



2. Enter a login user name and password, and then click [Login].

Note

- For details about the login user name and password, consult your administrator.
- You do not have to log in as an administrator to use Extended Feature Info only.

Web Image Monitor Operations Screens

The following explanation covers [Startup Setting], [Extended Feature Info], [Install], [Uninstall], and [Administrator Tools] screen items.

Note

- The [Additional Program Startup Setting], [Install Additional Program], [Uninstall Additional Program], [Copy Extended Features], and [Copy Card Save Data] screens are unavailable.

2

Startup Setting Screen

This section explains the various items on the Startup Setting screen.

For details about operations you can perform using this screen, see "Startup Setting".

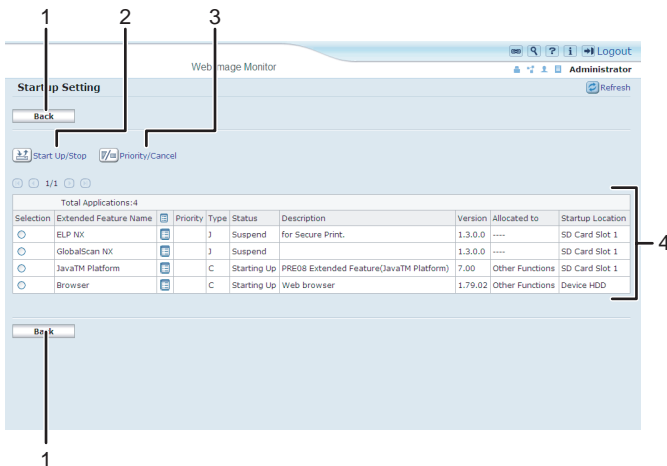

BXX001

1. [Back]

Click this to return to the [Configuration] menu of Web Image Monitor.

2. [Start Up/Stop]

Click this to set the selected extended feature to either "Starting Up" or "Stop".

3. [Priority/Cancel]

Click this button to set the "Priority" of the selected Type-J extended feature, or cancel the "Priority" setting. For details, see "Setting Priority".

4. Extended feature list

Displays a list of installed extended features.

Selection

- Click the radio button of the extended feature you want to set to "Starting Up" or "Stop". Click [Start Up/Stop] after selecting.

- Click the radio button of the Type-J extended feature to set or whose "Priority" setting you want to cancel. Click [Priority/Cancel] after selecting.

Extended Feature Name

Displays the names of extended features.

Properties

Displays an information screen for the extended feature, which allows you to check its [Properties] icon. For details, see "Extended Feature Info".

Priority

If multiple Type-J ^{*1} extended features are installed, they are displayed according to "Priority".

Type

Displays the types of extended features. For details, see "Types of Extended Features".

Status

Displays the status of extended features.

- Starting Up
Extended features are activated.
- Stop
Extended features are deactivated.
- Suspend
Only Type-J ^{*1} extended features are displayed.
Extended features are activated but are in standby status.
- Waiting
Only Type-C ^{*2} extended features are displayed.
Extended features are activated once the device is rebooted.
- Ending
Only Type-C ^{*2} extended features are displayed.
Extended features are shut down once the device is rebooted.

Description

Displays brief summaries of extended features.

Version

Displays the versions of extended features.

Allocated to

Displays the name of the function key allocated to the extended feature.

Startup Location

Displays the locations where extended features are installed.

^{*1} Embedded Software Architecture Application Java language version

^{*2} Embedded Software Architecture Application C language version

Note

- To set Startup Setting, you must login as an administrator. For details, see "Logging in as an Administrator".

Reference

- p.5 "Types of Extended Features"
- p.7 "Logging in as an Administrator"
- p.21 "Startup Setting"
- p.25 "Setting Priority"
- p.27 "Extended Feature Info"

Extended Feature Info Screen

This section explains the various items on the Extended Feature Info screen.

For details about operations you can perform using this screen, see "Extended Feature Info".

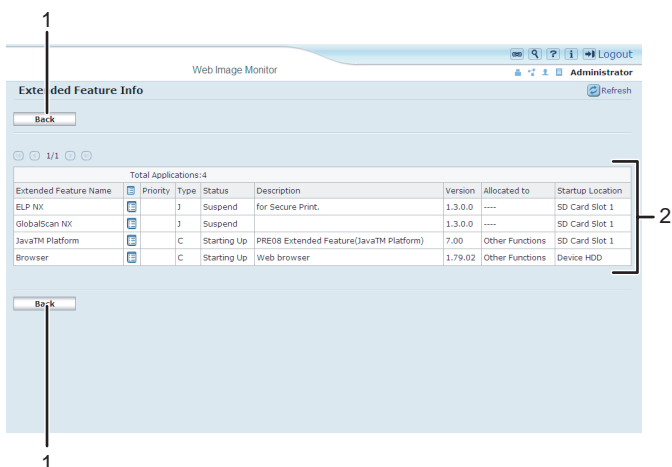

BXX002

1. [Back]

Click this to return to [Configuration] menu of Web Image Monitor.

2. Extended feature list

Displays a list of installed extended features.

Extended Feature Name

Displays the names of extended features.

Properties

Displays the extended feature information screen, allowing you check the [Properties] icon about the extended features. For details, see "Extended Feature Info".

Priority

If multiple Type-J ^{*1} extended features are installed, the extended feature displayed "Priority" is prioritized.

Type

Displays the types of extended features. For details, see "Types of Extended Features".

Status

Displays the status of extended features.

- Starting Up
Extended features are activated.
- Stop
Extended features are deactivated.
- Suspend
Only Type-J ^{*1} extended features are displayed.
Extended features are activated but are in standby status.
- Waiting
Only Type-C ^{*2} extended features are displayed.
Extended features are activated once the device is rebooted.
- Ending
Only Type-C ^{*2} extended features are displayed.
Extended features are shut down once the device is rebooted.

Description

Displays brief summaries of the extended features.

Version

Displays the versions of extended features.

Allocated to

The name of function key allocated to extended features are displayed.

Startup Location

Displays the locations where extended features are installed.

^{*1} Embedded Software Architecture Application Java language version

^{*2} Embedded Software Architecture Application C language version

Reference

- p.5 "Types of Extended Features"
- p.27 "Extended Feature Info"

Install Screen

This section explains the various items on the Install screen.

This screen allows you to install extended features.

For details about operations you can perform using this screen, see "Install".

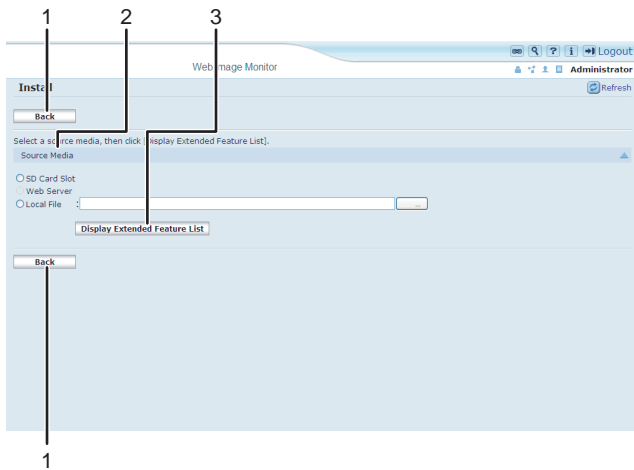

BYK705

1. [Back]

Click this to return to [Configuration] menu of Web Image Monitor.

2. Source Media

Select the storage media to use for performing installation of the extended features.

3. [Display Extended Feature List]

If you click [Display Extended Feature List], a list of the installable extended features stored in the source media (selected in Source Media) will appear.

↓ Note

- To set [Install], you must login as an administrator. For details, see "Logging in as an Administrator".

📖 Reference

- p.7 "Logging in as an Administrator"
- p.29 "Install"

Uninstall Screen

This section explains the various items on the Uninstall screen.

This screen allows you to uninstall extended features.

For details about operations you can perform using this screen, see "Uninstall".

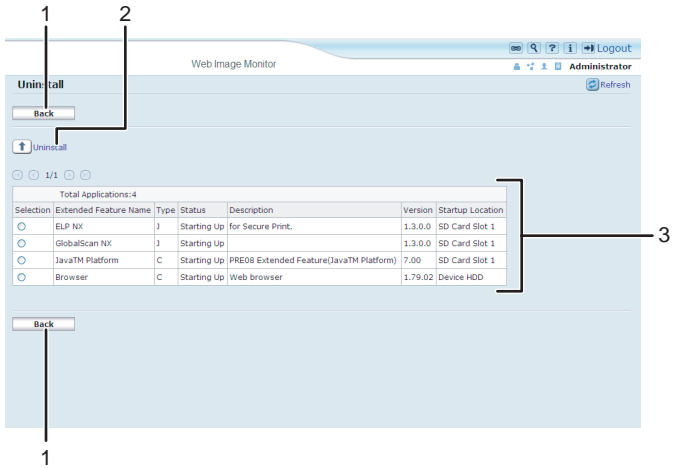

BXX006

1. [Back]

Click this to return to [Configuration] menu of Web Image Monitor.

2. [Uninstall]

If you click [Uninstall], the extended features selected in the Extended Features list will be uninstalled.

3. Extended feature list

Displays a list of installed extended features.

Selection

Click the radio button(s) of the extended feature that you want to uninstall, and then click [Uninstall] to begin the uninstall process.

Extended Feature Name

Displays the names of extended features.

Type

Displays the types of extended features. For details, see "Types of Extended Features".

Status

Displays the status of extended features.

- Starting Up
Extended features are activated.
- Stop
Extended features are deactivated.
- Suspend
Only Type-J*¹ extended features are displayed.
Extended features are activated but are in standby status.
- Waiting
Only Type-C*² extended features are displayed.
Extended features are activated once the device is rebooted.

- Ending
Only Type-C*² extended features are displayed.
Extended features are shut down once the device is rebooted.
- *¹ Embedded Software Architecture Application Java language version
- *² Embedded Software Architecture Application C language version

Description

Displays brief summaries of the extended features.

Version

Displays the versions of extended features.

Startup Location

Displays the locations where extended features are installed.

Note

- To set [Uninstall], you must login as an administrator. For details, see "Logging in as an Administrator".

Reference

- p.5 "Types of Extended Features"
- p.7 "Logging in as an Administrator"
- p.31 "Uninstall"

Administrator Tools Screen

This section explains the various items on the Administrator Tools screen.

For details about operations you can perform using this screen, see "Administrator Tools".

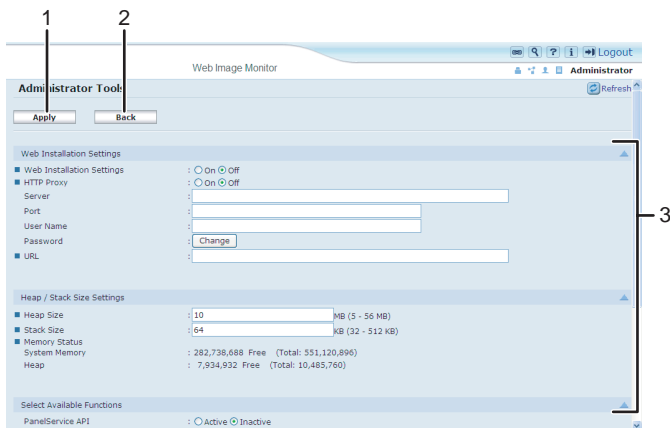

BXX004

1. [Apply]

Click this to apply changes made to settings.

2. [Back]

Click this to return to the [Configuration] menu of Web Image Monitor.

3. Settings list

Displays a list of settings.

- Web Installation Settings
Specify installation of extended features through the network.
- Heap / Stack Size Settings
Specify the heap and stack size necessary for extended features.
- Select Available Functions
Specify enable/disable for Java™ Platform functions from the list.
- Web Service Settings
Configure the network-related settings.

Note

- To set [Administrator Tools], you must login as an administrator. For details, see "Logging in as an Administrator".
- You can specify Heap / Stack Size Settings and Web Service Settings.

Reference

- p.7 "Logging in as an Administrator"
- p.33 "Administrator Tools"

Other Screens

The following explanation covers [Additional Program Startup Setting], [Install Additional Program], and [Uninstall Additional Program] screen items.

Note

- The [Additional Program Startup Setting], [Install Additional Program], [Uninstall Additional Program], [Copy Extended Features], and [Copy Card Save Data] screens are unavailable.
- For information about these settings, consult your nearest sales or service representative.

Additional Program Startup Setting screen

This section explains the various items on the Additional Program Startup Setting screen.

This screen allows you to start and stop installed additional programs.

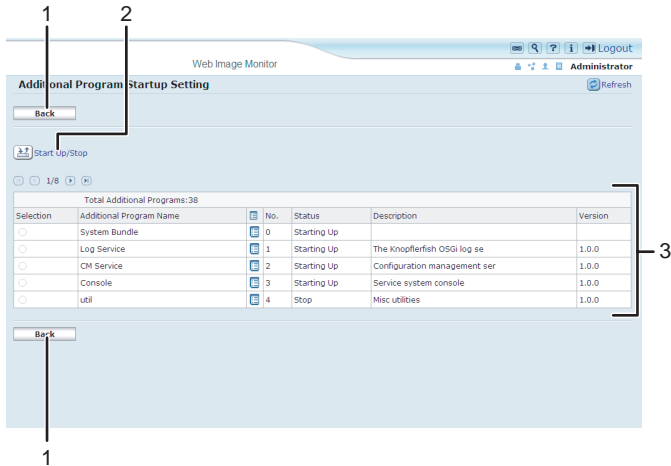

BXX007

1. [Back]

Click this to return to the [Configuration] menu of Web Image Monitor.

2. [Start Up/Stop]

Click this to set the selected additional program to either "Starting Up" or "Stop".

3. Additional program list

Displays a list of installed additional program.

Selection

Click the radio button of the additional program you want to set to "Starting Up" or "Stop". Click [Start Up/Stop] after selecting.

Additional Program Name

Displays the names of additional program.

Properties

Displays an information screen for the additional program, which allows you to check its [Properties] icon.

No.

Displays the ID of each additional program that is installed.

Status

Displays the status of additional program.

- Starting Up
Additional program are activated.
- Stop
Additional program are deactivated.
- Suspend
Additional program are activated but are in standby status. You must reboot before you can use these features.

Description

Displays brief summaries of additional program.

Version

Displays the versions of additional program.

2

Install Additional Program screen

This section explains the various items on the Install Additional Program screen.

This screen allows you to install additional program.

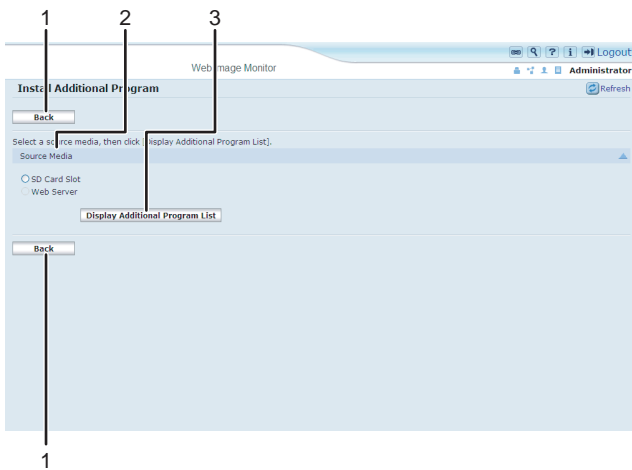

BXX008

1. [Back]

Click this to return to [Configuration] menu of Web Image Monitor.

2. Source Media

Select the storage media to use for performing installation of the additional program.

3. [Display Additional Program List]

If you click [Display Additional Program List], a list of the installable additional programs stored in the source media (selected in Source Media) will appear.

Uninstall Additional Program screen

This section explains the various items on the Uninstall Additional Program screen.

This screen allows you to uninstall additional program.

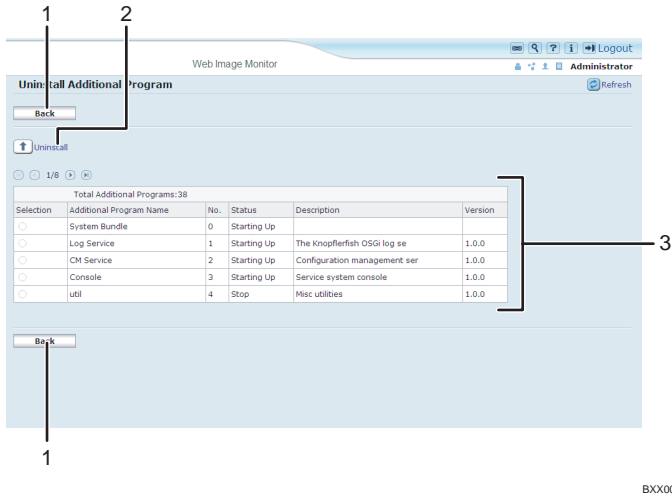

BXX009

1. [Back]

Click this to return to [Configuration] menu of Web Image Monitor.

2. [Uninstall]

If you click [Uninstall], the extended features selected in the additional programs list will be uninstalled.

3. Additional program list

Displays the status of additional program.

Selection

Click the radio button(s) of the additional program that you want to uninstall, and then click [Uninstall] to begin the uninstall process.

Additional Program Name

Displays the names of additional program.

No.

Displays the ID of each additional program that is installed.

Status

Displays the status of additional program.

- Starting Up

Additional program are activated.

- Stop

Additional program are deactivated.

- Suspend

Additional program are activated but are in standby status. You must reboot before you can use these features.

Description

Displays brief summaries of the additional program.

Version

Displays the versions of additional program.

3. Startup Setting

This chapter explains the operations that are available from the Startup Setting screen of Web Image Monitor.

Starting and Stopping Extended Features

For details about items on the Startup Setting screen, see "Startup Setting Screen".

Note

- To set [Startup Setting], you must login as an administrator. For details, see "Logging in as an Administrator".

Reference

- p.7 "Logging in as an Administrator"
- p.9 "Startup Setting Screen"

Starting Extended Features

1. Display the configuration menu screen on Web Image Monitor.
2. In "Extended Feature Settings", click [Startup Setting].
A list of installed extended features appears.
3. Select the extended features you want to start, from those whose status is "Stop", "Suspend", or "Ending". Select the radio button at the "Selection" in the list.

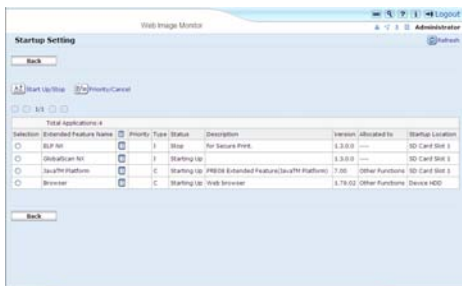

4. Click [Start Up/Stop].

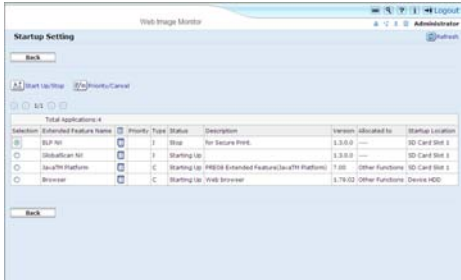

Depending on the type and status of the extended features you select, the machine responds as follows:

Type-J *1 extended features

- If "Suspend" is displayed:
 "Status" changes to "Stop".
 If you click [Start Up/Stop] again, "Status" changes to "Starting Up". The extended features start and become usable.
- If "Stop" is displayed:
 "Status" changes to "Starting Up". The extended features start and become usable.

Type-C *2 extended features

- If "Ending" is displayed:
 "Status" changes to "Starting Up". The extended features start and become usable.
- If "Stop" is displayed:
 "Status" changes to "Waiting".
 After rebooting the device, "Status" changes to "Starting Up". The extended features start and become usable.
 If you click [Start Up/Stop] again without rebooting, "Status" changes back to "Stop".

*1 Embedded Software Architecture Application Java language version

*2 Embedded Software Architecture Application C language version

5. Click [Back].

Note

- If "Waiting" is displayed, "Status" changes to "Starting Up" after rebooting the device. The extended features start and become usable.

Reference

- p.7 "Displaying the Operation Screen"

Stopping Extended Features

Normally it is not necessary to stop extended features.

Extended features that are required for communication with the server may stop if the server is deactivated.

1. Display the configuration menu screen on Web Image Monitor.
2. In "Extended Feature Settings", click [Startup Setting].
A list of installed extended features is displayed.
3. Select the extended features you want to stop, from those whose status is "Starting Up", "Suspend", or "Waiting". Select the radio button at the "Selection" in the list.

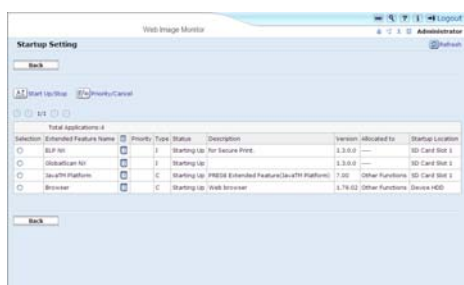

4. Click [Start Up/Stop].

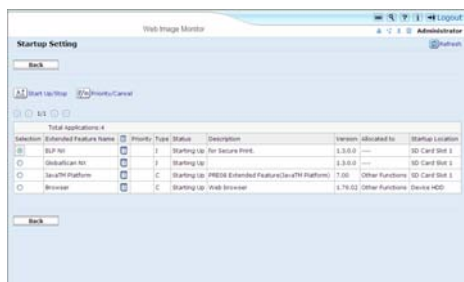

Depending on the type and status of the extended features you select, the machine responds as follows:

Type-J ^{*1} extended features

- If "Suspend" is displayed:
"Status" changes to "Stop". The extended features stop and become unusable.
- If "Starting Up" is displayed:
"Status" changes to "Stop". The extended features stop and become unusable.

Type-C ^{*2} extended features

- If "Waiting" is displayed:
"Status" changes to "Stop". The extended features stop and become unusable.
- If "Starting Up" is displayed:

"Status" changes to "Ending".

After rebooting the device, "Status" changes to "Stop". The extended features stop and become unusable.

If you click [Start Up/Stop] again without rebooting, "Status" changes back to "Starting Up".

*1 Embedded Software Architecture Application Java language version

*2 Embedded Software Architecture Application C language version

3

5. Click [Back].

 **Note**

- If "Ending" is displayed, "Status" changes to "Stop" after rebooting the device. The extended features stop and become unusable.

 **Reference**

- p.7 "Displaying the Operation Screen"

Setting Priority

You can set priority for Type-J extended features only.

If multiple Type-J extended features are installed, you can specify their activation priority.

1. Display the configuration menu screen on Web Image Monitor.
2. In "Extended Feature Settings", click [Startup Setting].

A list of installed extended features appears.

3. Select the Type-J extended features you want to priority activate. Select the radio button at the "Selection" in the list.

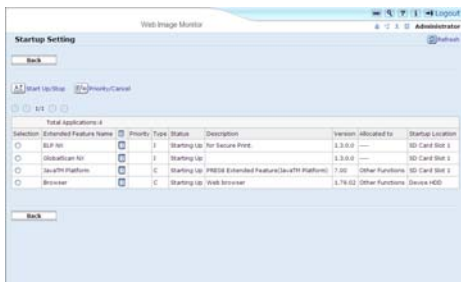

4. Click [Priority/Cancel].

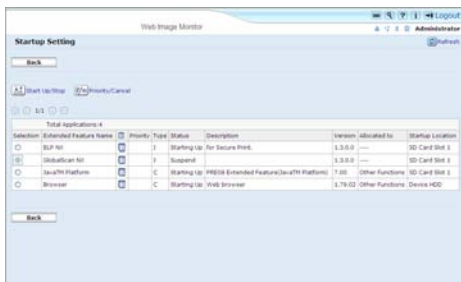

"Priority" is displayed at the "Priority" for the selected Type-J extended feature in the list.

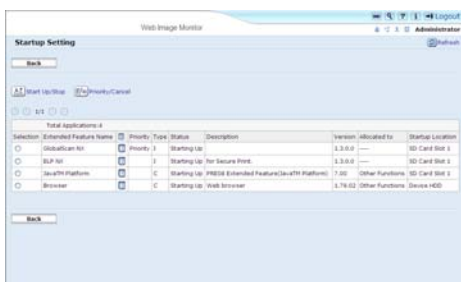

Note

- To cancel "Priority", select a Type-J extended feature that is set to "Priority", and then click [Priority/Cancel].

 **Reference**

- p.7 "Displaying the Operation Screen"

4. Extended Feature Info

This chapter explains the operations that are available from the Extended Feature Info screen of Web Image Monitor.

Displaying Extended Feature Information

1. Display the configuration menu screen on Web Image Monitor.
2. In the "Extended Feature Settings", click the [Extended Feature Info].

A list of installed extended features appears.

For details about items on the Extended Feature Info screen, see "Extended Feature Info Screen".

3. Click the [Properties] icon of the extended feature whose details you want to display.

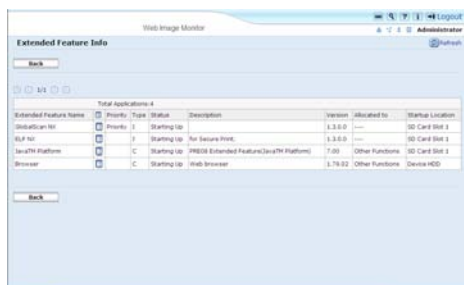

4. Check the information, and then click [Back].



5. Click [Back].

Reference

- p.7 "Displaying the Operation Screen"
- p.11 "Extended Feature Info Screen"

5. Install

This chapter explains the operations that are available from the Install screen of Web Image Monitor.

Installing Extended Features

Use the following procedure to install extended feature.

For details about the install screen, see "Install Screen".

1. Display the configuration menu screen on Web Image Monitor.
2. In "Extended Feature Settings", click [Install].
3. Select either [SD Card Slot] or [Local File] as the location of the installation source file.

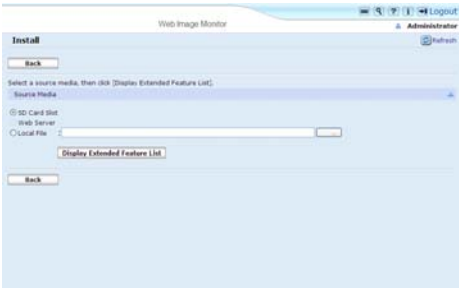

If you select [Local File], you must then specify the location of the zip file containing the extended features.

4. Click [Display Extended Feature List].
5. Specify the installation destination for extended feature.



6. Select whether or not to run Type-J features automatically.

7. In the list, select the extended features you want to install, and then click [Install].

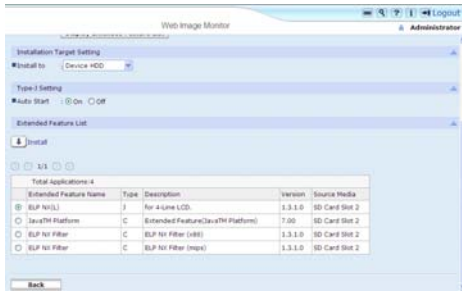

A confirmation message appears.

8. Click [OK].

9. Click [Back].

Note

- To set [Install], you must login as an administrator. For details, see "Logging in as an Administrator".
- If you have installed an extended feature on the SD Card that contains the installation source file, the installed extended feature will disappear from the list. To make the extended feature reappear, uninstall it. Note however that if you have installed a different version of an extended feature by overwriting the previous installation, you cannot restore the previous version by uninstalling the newer version.

Reference

- p.7 "Displaying the Operation Screen"
- p.7 "Logging in as an Administrator"
- p.12 "Install Screen"

6. Uninstall

This chapter explains the operations that are available from the Uninstall screen of Web Image Monitor.

Uninstalling Extended Features

Use the following procedure to uninstall extended features.

For details about the Uninstall screen, see "Uninstall Screen".

1. Display the configuration menu screen on Web Image Monitor.
2. In "Extended Feature Settings", click [Uninstall].
A list of installed extended features appears.
3. In the "Selection" area of the list, select the radio button of the extended features you want to uninstall.
4. Click [Uninstall].

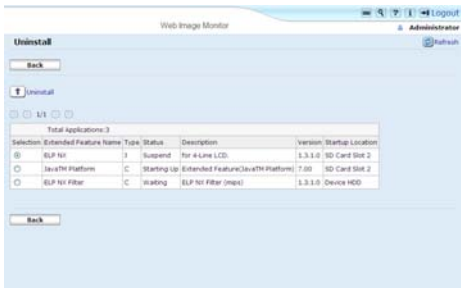

A confirmation message appears.

5. Click [OK].
If a selected extended feature is currently running, a confirmation message will appear. To proceed with the uninstallation, click [OK].
6. Click [Back].

Note

- To set [Uninstall], you must login as an administrator. For details, see "Logging in as an Administrator".

Reference

- p.7 "Displaying the Operation Screen"
- p.7 "Logging in as an Administrator"
- p.13 "Uninstall Screen"

7. Administrator Tools

This chapter explains the operations that are available from the Administrator Tools screen of Web Image Monitor.

Setting Heap / Stack Size

Change the settings of "Heap Size" *1 and "Stack Size" *2 for Type-J extended features.

*1 "Heap" refers to a memory area used by Java™ Platform and related applications.

*2 "Stack" refers to a memory area used to store temporary data for an application.

1. Display the configuration menu screen on Web Image Monitor.
2. In "Extended Feature Settings", click [Administrator Tools].

The screen for setting "Heap Size" and "Stack Size" appears. The current "Free" and "Total" capacity of System Memory and Heap appear at the bottom of the screen.

For details about items on the Administrator Tools screen, see "Administrator Tools Screen".

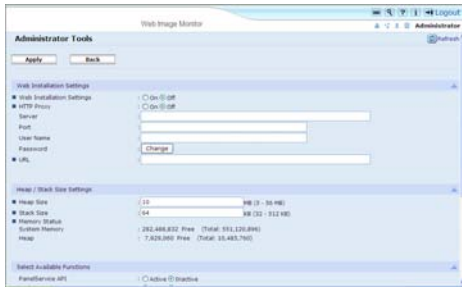

3. Enter the values for "Heap Size" and "Stack Size".
4. Click [Apply].

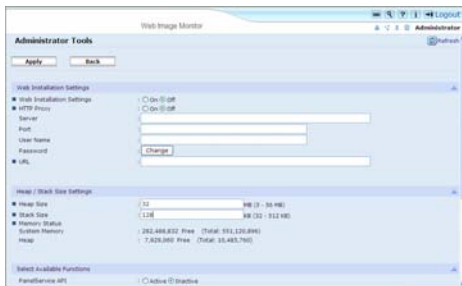

A confirmation message appears.

5. Click [OK].
6. Click [Back].

 **Note**

- To set [Administrator Tools], you must login as an administrator. For details, see "Logging in as an Administrator".
- You can specify Heap / Stack Size Settings and Web Service Settings.
- Changed settings are activated after the device has been rebooted.

 **Reference**

- p.7 "Displaying the Operation Screen"
- p.7 "Logging in as an Administrator"
- p.15 "Administrator Tools Screen"

Web Service Settings

This section explains Web Service Settings. These settings allow you to enable and disable the communication protocols used by extended features.

Note

- You can specify Heap / Stack Size Settings and Web Service Settings.
- [Remote Installation Password] is unavailable.

Enabling/Disabling Communication Protocols

Use the following procedure to select the communication protocols (HTTP/HTTPS) used by extended features.

1. Display the configuration menu screen on Web Image Monitor.
2. In "Extended Feature Settings", click [Administrator Tools].
For details about items on the Administrator Tools screen, see "Administrator Tools Screen".
3. Under "Web Service Settings", select whether to enable or disable [HTTP] or [HTTPS].

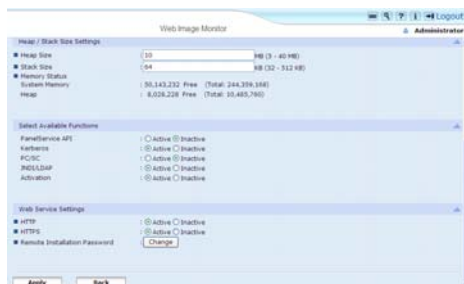

[HTTP] and [HTTPS] cannot be disabled at the same time.

4. Click [Apply].
A confirmation message appears.
5. Click [OK].
6. Click [Back].

Note

- To set [Administrator Tools], you must login as an administrator. For details, see "Logging in as an Administrator".

Reference

- p.7 "Displaying the Operation Screen"
- p.7 "Logging in as an Administrator"

- p.15 "Administrator Tools Screen"

8. Appendix

Trademarks

Java and all Java-based trademarks and logos are trademarks or registered of Sun Microsystems, Inc. in the United States and other countries.

INDEX

A

Additional Program Startup Setting screen.....	16
Administrator Tools screen.....	15

D

Displaying extended feature information.....	27
Displaying the operation screen.....	7

E

Extended Feature Info screen.....	11
-----------------------------------	----

I

Install.....	29
Install Additional Program screen.....	18
Install screen.....	12

L

Logging in as an administrator.....	7
-------------------------------------	---

P

protocols.....	35
----------------	----

S

Setting Heap / Stack Size.....	33
Setting priority.....	25
Starting and Stopping extended features.....	21
Starting extended features.....	21
Startup Setting screen.....	9
Stopping extended features.....	23

T

This manual.....	6
Type-C extended features.....	5
Type-J extended features.....	5
Types of extended features.....	5

U

Uninstall.....	31
Uninstall Additional Program screen.....	18
Uninstall screen.....	13

W

Web Image Monitor operations screens.....	9
Web service settings.....	35
What are extended features?.....	5

MEMO

VM Card Operating Instructions Extended Feature Settings Web Reference





Operating Instructions Enhanced Locked Print NX User's Guide

-
- 1 Introduction
 - 2 Setting Up the Printer Driver
 - 3 Using the Control Panel
 - 4 Appendix

Introduction

Do not copy or print any item for which reproduction is prohibited by law.

Copying or printing the following items is generally prohibited by local law:

bank notes, revenue stamps, bonds, stock certificates, bank drafts, checks, passports, driver's licenses.

The preceding list is meant as a guide only and is not inclusive. We assume no responsibility for its completeness or accuracy. If you have any questions concerning the legality of copying or printing certain items, consult with your legal advisor.

Important

Contents of this manual are subject to change without prior notice.

In no event will the company be liable for direct, indirect, special, incidental, or consequential damages as a result of handling or operating the machine.

For good print quality, the manufacturer recommends that you use genuine toner from the manufacturer.

The manufacturer shall not be responsible for any damage or expense that might result from the use of parts other than genuine parts from the manufacturer with your office products.

Some illustrations in this manual might be slightly different from the machine.

Certain options might not be available in some countries. For details, please contact your local dealer.

TABLE OF CONTENTS

- How to Read This Manual.....2
 - Symbols.....2
 - Abbreviations.....2
- 1. Introduction**

- About Enhanced Locked Print NX.....3
 - Accessing Extended Features.....3
- 2. Setting Up the Printer Driver**

- Configuring the Authentication Setting.....5
- Sending Print Jobs.....6
 - When User Authentication is Disabled.....6
 - When User Authentication is Enabled.....6
- 3. Using the Control Panel**

- Logging In.....9
 - When User Authentication is Disabled.....9
 - When User Authentication is Enabled.....10
- Functions on the User Screen.....11
- Printing Jobs Using the Control Panel.....12
- Deleting Jobs Using the Control Panel.....13
- 4. Appendix**

- Trademarks.....15
- INDEX**.....17

How to Read This Manual

In order to familiarize yourself with the many capabilities of Enhanced Locked Print NX functions, we recommend that you read this guide in its entirety. You will then be prepared to securely send, release, and manage documents.

Important

- Keep this manual in a safe place for future reference.

Symbols

This manual uses the following symbols:

Important

Indicates points to pay attention to when using the machine, and explanations of likely causes of paper misfeeds, damage to originals, or loss of data. Be sure to read these explanations.

Note

Indicates supplementary explanations of the machine's functions, and instructions on resolving user errors.

Reference

This symbol is located at the end of sections. It indicates where you can find further relevant information.

[]

Indicates the names of keys on the machine's display or control panels.

Abbreviations

The following abbreviations are used in this manual.

Product/Name	Abbreviation
Enhanced Locked Print NX	ELP NX

1. Introduction

This chapter provides a brief overview of ELP NX.

About Enhanced Locked Print NX

1

- Users log in to ELP NX using one of two methods: When authentication is not set (disabled) on the printer, users enter the ID and password specified for each job in the printer driver; when authentication is set (enabled), users enter the login user name and password pre-specified in the printer driver.
- For security, only jobs related to the logged-in user appear on the display panel. This prevents unauthorized users accessing and printing other user's jobs.
- ELP NX is a printing application that allows users to securely send print jobs from a computer to a network-connected printer. This application also allows users to send print jobs stored on the printer to another device.
- ELP NX is installed in the printer itself, and compresses, encrypts, and stores documents securely in the printer.
- Up to 500 print jobs for each user can be stored on the local hard disk of the printer.
- The maximum page count per job is 9999.

Accessing Extended Features

Use the following procedure to access ELP NX with the [Switch Functions] key on the printer.

1. Press the [Switch Functions] key.
2. Press the [▼] or [▲] key to select [Java™/X], and then press the [OK] key.
3. If more than one extended feature is installed, use the [▼] or [▲] key to select [ELP NX (L)], and then press the [OK] key.

The ELP NX screen appears. Log in to ELP NX.

Note

- For details about how to log in when user authentication is set on the printer, consult your administrator.

2. Setting Up the Printer Driver

This chapter explains how to configure the authentication setting of the printer driver, and how to send jobs to a printer. Users will be able to send jobs to a printer after the authentication setting is configured using the printer driver screen.

Configuring the Authentication Setting

2

Use the following procedure to configure the authentication setting.

Using the PCL6 printer driver as an example, the following procedure explains how to configure the authentication settings.

★ Important

- ELP NX supports PCL 5e, 5c, or 6, and PostScript 3 printer drivers.
- When user authentication is set on the printer, only the PCL 5e, 5c, or 6 printer drivers can be used.

1. On the [Start] menu, click [Printers and Faxes].

The [Printers and Faxes] window appears.

2. Click the icon of the printer you want to configure authentication for.

3. On the [File] menu, click [Properties].

The [Printer Properties] dialog box appears.

4. Click the [Advanced Options] tab, and then select the [User Authentication] check box.

If user authentication is enabled, select the [User Authentication] check box.

If user authentication is disabled, clear the [User Authentication] check box.

5. Click [OK].

The [Printer Properties] dialog box closes.

Sending Print Jobs

This section explains how to configure the printer driver to send print jobs to the printer.

The printer driver settings will differ depending on whether user authentication is disabled or enabled.

↓ Note

- For details about how to send print jobs to a print server, see "Enhanced Locked Print NX FlexRelease Server User's Guide".

When User Authentication is Disabled

Use the following procedure to configure the printer driver when user authentication is disabled.

1. **Open the document you want to print in its native application. On the [File] menu of the application, click [Print].**
The [Print] dialog box appears.
2. **Select the printer that you want to use, and then click [Preferences].**
3. **In the [Printing Preferences] dialog box, click the [Detailed Settings] tab, and then select the [Job Setup] icon.**
4. **In the [Job Type:] list, select [Locked Print], and then click [Details...].**
5. **Enter a user ID in [User ID:], using up to eight characters, and then enter a password in [Password:], using from four to eight characters. Then click [OK].**

Enter the same login user name and password used to log in to ELP NX. If you change the login user ID and password, be sure to enter the new login user ID and password. If you do not, sent jobs cannot be printed and will be canceled.

6. **Click [OK].**
The [Printing Preferences] dialog box closes.
7. **Click [Print].**
The print job is sent to the printer.

When User Authentication is Enabled

Use the following procedure to configure the printer driver when user authentication is enabled.

1. **Open the document you want to print in its native application. On the [File] menu of the application, click [Print].**
The [Print] dialog box appears.
2. **Select the printer that you want to use, and then click [Preferences].**

3. In the [Printing Preferences] dialog box, click the [Detailed Settings] tab, and then select the [Job Setup] icon.
4. In the [Job Type:] list, select [Normal Print].
5. Click [Authentication...].
6. Enter the login user name in [Login User Name:], using up to 32 characters, and then enter a password in [Login Password:], using up to 128 characters. Then reenter the password in [Reenter the confirmation password:], and then click [OK].

Enter the same login user name and password used to log in to the printer. If you change the login user name and password, be sure to enter the new login user name and password. If you do not, sent jobs cannot be printed and will be canceled.

7. Click [OK].

The [Printing Preferences] dialog box closes.

8. Click [Print].

The print job is sent to the printer.

3. Using the Control Panel

This chapter explains how to log in to the printer, and check, print, and delete jobs using the control panel.

Logging In

This section explains the procedure for logging in to this printer. The procedure differs depending on whether user authentication is disabled or enabled.

When User Authentication is Disabled

Use the following procedure to log in when user authentication is disabled.

1. Press the [Switch Functions] key.

The [Switch Func.] screen appears.

2. Press the [▼] or [▲] key to select [JavaTM/X], and then press the [OK] key.
3. If more than one extended feature is installed, use the [▼] or [▲] key to select [ELP NX (L)], and then press the [OK] key.

The user list screen appears.

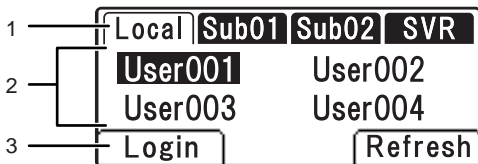

BYK700

1. Database display tab
2. User name
3. Login
4. Press the [▶] or [◀] key to select a database.

Press [Refresh] to display an updated user list.

Names of databases are displayed using up to five characters, and the user name is displayed using up to ten characters.

5. Press the [▼] or [▲] key to select a user name, and then press [Login].
6. Enter a login password using the number keys, and then press the [OK] key.

The user screen appears.

When User Authentication is Enabled

Use the following procedure to log in when user authentication is enabled.

1. Press the [Switch Functions] key.

The [Switch Func.] screen appears.

2. Press the [▼] or [▲] key to select [JavaTM/X], and then press the [OK] key.
3. If more than one extended feature is installed, use the [▼] or [▲] key to select [ELP NX (L)], and then press the [OK] key.
4. Log in to the printer.

The procedure for logging in to the printer differs depending on the authentication settings. For details about how to log in to the printer, consult your administrator.

If authentication fails, the message "Authentication failed." will appear. Consult your administrator about how to proceed.

The user screen appears.

Functions on the User Screen

The user screen will appear after you have logged in.

The following items are available on this screen.

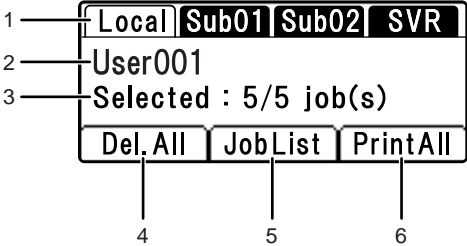

BYK701

1. Database display tab

Displays the databases where print jobs are stored.

2. User name

Displays the user name of the logged-in user.

3. Total

Displays the total number of jobs belonging to the logged-in user.

4. Del.All

Press to delete all jobs.

5. JobList

Displays a list of print jobs.

6. PrintAll

Press to print job(s).

Note

- The database tabs are displayed only when user authentication is set.
- To use the "SVR" tab function, the optional Enhanced Locked Print NX FlexRelease Server is required.

Printing Jobs Using the Control Panel

Use the following procedure to print jobs using the job list displayed on the control panel.

1. **Log in using the procedure shown in the preceding section (under "Logging In").**

The user screen appears.

2. **Press [JobList].**

A list of the logged-in user's jobs appears.

3. **Press the [▼] or [▲] key to select the job that you want to print, and then press the [OK] key.**

Multiple jobs can be selected.

To deselect a job, press the [▼] or [▲] key to select the job, and then press the [OK] key.

4. **Press [Print].**

The selected jobs are printed.

↓ Note

- To return to the user screen, press the [Escape] key.
- While printing is in progress, other operations are not possible and the user cannot log out.

📖 Reference

- p.9 "Logging In"

Deleting Jobs Using the Control Panel

Use the following procedure to delete jobs using the job list displayed on the control panel.

1. **Log in using the procedure shown in the preceding section (under "Logging In").**

The user screen appears.

2. **Press [JobList].**

A list of the logged-in user's jobs appears.

3. **Press the [▼] or [▲] key to select the job that you want to delete, and then press the [OK] key.**

Multiple jobs can be selected.

To deselect a job, press the [▼] or [▲] key to select the job, and then press the [OK] key.

4. **Press [Delete].**

5. **Press [Yes].**

The selected jobs are deleted.

↓ Note

- To return to the user screen, press the [Escape] key.
- While deleting is in progress, other operations are not possible and the user cannot log out.

4. Appendix

Trademarks

IPS is a trademark or registered trademark of Zoran Corporation and/or its subsidiaries in the United States or other countries.

Java™, Java™ Card, JVM™ (CVM), and CDC are trademarks or registered trademarks of Sun Microsystems, Inc. in the United States and/or other countries.

PCL® is a registered trademark of Hewlett-Packard Company.

PostScript is a registered trademark or trademark of Adobe Systems Incorporated in the United States and/or other countries.

Other product names used herein are for identification purposes only and might be trademarks of their respective companies. We disclaim any and all rights to those marks.

INDEX

A

Abbreviations.....	2
Authentication setting.....	5

E

Enhanced Locked Print NX.....	3
-------------------------------	---

J

Job list.....	12, 13
---------------	--------

L

Login.....	9, 10
------------	-------

P

Printing preferences.....	6
---------------------------	---

S

Sending print jobs.....	6
Switch functions (key).....	3
Symbols.....	2

T

Trademarks.....	15
-----------------	----

U

User screen.....	11
------------------	----

MEMO

MEMO

MEMO





UNIX Supplement

-
- 1 Command Configuration
 - 2 Remote Maintenance Using telnet

Introduction

This manual contains detailed instructions and notes on the operation and use of this machine. For your safety and benefit, read this manual carefully before using the machine. Keep this manual in a handy place for quick reference.

Do not copy or print any item for which reproduction is prohibited by law.

Copying or printing the following items is generally prohibited by local law:

bank notes, revenue stamps, bonds, stock certificates, bank drafts, checks, passports, driver's licenses.

The preceding list is meant as a guide only and is not inclusive. We assume no responsibility for its completeness or accuracy. If you have any questions concerning the legality of copying or printing certain items, consult with your legal advisor.

Important

Contents of this manual are subject to change without prior notice.

In no event will the company be liable for direct, indirect, special, incidental, or consequential damages as a result of handling or operating the machine.

For good print quality, the manufacturer recommends that you use genuine toner from the manufacturer.

Note

This manual covers several different models, and therefore contains functions and settings that may not be available for your model.

Functions and supported operating systems may differ from those of your model.

TABLE OF CONTENTS

- How to Read This Manual.....4
 - Symbols.....4
- 1. Command Configuration**

- Before Setup.....5
 - Using the lp/lpr Commands.....5
 - Using the rsh/rcp/ftp Commands.....5
 - Windows Setup.....5
- Using the Installation Shell Script.....7
 - Assigning the IP Address.....7
 - Executing the Installation Shell Script.....8
 - After Executing the Installation Shell Script.....11
 - Solaris.....13
 - HP-UX.....14
- Printing Method.....16
 - Printing with lpr, lp.....16
 - Printing with rsh, rcp, ftp.....17
- Printer Status.....19
 - Viewing the Print Job Status with lpq and lpstat.....19
 - Viewing the Printer Status with rsh and ftp.....19
 - Copying Information to a File.....20
- Specifying the Device Option.....21
 - Configuring the Device Option.....21
 - Printer Language.....24
 - Text Printing.....25
 - Input Tray.....25
 - Paper Size.....26
 - Paper Type.....27
 - Output Tray.....29
 - Copies.....30
 - Collating.....30
 - Duplex Printing.....31
 - Binding.....31
 - Orientation.....32

Image Direction.....	33
Resolution.....	33
Gradation Quality.....	34
Billing Code.....	35
Usercode.....	35
Symbol Set.....	36

2. Remote Maintenance Using telnet

Using telnet.....	39
8021x.....	40
access.....	41
authfree.....	42
autonet.....	43
bonjour.....	44
devicename.....	45
dhcp.....	46
dhcpó.....	47
diprint.....	47
dns.....	48
domainname.....	50
etherauth.....	51
etherconfig.....	51
help.....	51
hostname.....	51
ifconfig.....	52
info.....	53
ipds.....	54
ipsec.....	54
ipp.....	54
ipvó.....	55
logout.....	55
lpr.....	56
netware.....	56
passwd.....	57

pathmtu.....	58
prnlog.....	58
rhpp.....	59
route.....	59
set.....	61
show.....	64
slp.....	64
smb.....	64
snmp.....	65
sntp.....	68
spoolsw.....	69
ssdp.....	69
ssh.....	70
status.....	71
syslog.....	71
upnp.....	71
web.....	71
wiconfig.....	72
wins.....	76
wsmfp.....	77
Getting Printer Information over the Network.....	79
Current Printer Status.....	79
Printer Configuration.....	83
Understanding the Displayed Information.....	85
Print Job Information.....	85
Print Log Information.....	85
Configuring the Network Interface Board.....	86
Message List.....	97
System Log Information.....	97
INDEX	109

How to Read This Manual

Symbols

This manual uses the following symbols:

Important

Indicates points to pay attention to when using the machine, and explanations of likely causes of paper misfeeds, damage to originals, or loss of data. Be sure to read these explanations.

Note

Indicates supplementary explanations of the machine's functions, and instructions on resolving user errors.

Reference

This symbol is located at the end of sections. It indicates where you can find further relevant information.

[]

Indicates the names of keys on the machine's display or control panels.

1. Command Configuration

This chapter explains how to set up a network printer and check print status.

Before Setup

This section explains the preparation procedures required before you can use commands.

★ Important

- To print from a UNIX workstation, use a file that the printer supports.
- Setting up varies depending on the printing commands. Make sure to make settings accordingly.

Using the lp/lpr Commands

1. Use the installation shell script to register the device option, as well as the printer host name and the IP address.

For details, see p.7 "Using the Installation Shell Script".

2. Start printing.

For details, see p.16 "Printing Method".

Using the rsh/rcp/ftp Commands

★ Important

- Only the standard UNIX rsh and rcp commands are supported.
1. Edit the host file to register the printer host name and the IP address.

For details, see p.11 "After Executing the Installation Shell Script"

2. Start printing.

For details, see p.16 "Printing Method".

↓ Note

- If you cannot edit the host file, use the install shell script to register the host name.

Windows Setup

Follow the procedure below to make network environment settings.

- 1. Enable TCP/IP with the control panel, and then set up the printer's network environment about TCP/IP including IP addresses.**

TCP/IP of the printer is set as default.

- 2. Install a TCP/IP in Windows to set up the network environment.**

Consult the administrator for the local setting information.

- 3. To print under Windows, install "Printing service for UNIX" or "LPD Print Service" as the network application.**

Note

- For details about setting up IPv4 address, see "Configuration", Hardware Guide.
- For details about setting the IPv4 address of the printer using DHCP, see "Using DHCP", Software Guide.

Using the Installation Shell Script

The installation shell script helps with the setup process. The installation shell script automates some of the tasks in configuring `/etc/hosts`, `/etc/printcap`; creating the spool directory for BSD UNIX; and running the `lpadmin` command for System V UNIX.

★ Important

- The installation shell script can be used on the following workstations: (it cannot be used with other types of workstations.)
 - SunOS 4.x.x
 - Solaris 2.x(Sun OS 5.x), Solaris 7, Solaris 8
 - HP-UX
 - Red Hat Linux
 - UnixWare
 - OpenServer

↓ Note

- Depending on security settings when installed, `rsh/rcp/telnet` may not be usable with Red Hat 7.1 or later. Change the security level to allow use of `rsh/rcp/telnet`. For details about how to change the setting, see the operating instructions for Red Hat.
- When you use NIS (Network Information Service) or DNS, you should configure the server before running the installation shell script.
- Installation shell script does not support CUPS.
- When you use Solaris and HP-UX, you can set UNIX configuration with `admintools` that came with Solaris and HP-UX. For details about setting using the `admintools`, see the `admintool`'s manual.
- For details about the configuration utility of your operating system, see the manual that came with the utility.

Assigning the IP Address

★ Important

- Configure the printer to use TCP/IP.
 - Make sure that TCP/IP on the printer is set to active. (Default setting is active.)
 - Assign an IP address to the printer and configure the other settings required for TCP/IP.

↓ Note

- For details about how to make the above settings, see the manual that comes with this printer.

Checking the IP address configuration

Follow the procedure below to make sure that the IP address has been configured correctly.

- The following procedure uses the sample IP address: 192.168.15.16.

1. Enter the following:

```
# ping 192.168.15.16
```

If the address has been configured correctly, the following message appears:

```
192.168.15.16 is alive
```

If the address has been configured incorrectly, the following message appears:

```
no answer from 192.168.15.16
```

↓ Note

- When you use NIS, the IP address and host name are written to `/etc/hosts` on the master server. When you use DNS, the information is written to a data file on the name server. After writing the host name and IP address to the file, make sure that the configuration is correct by pinging the host.

```
# ping host_name
```

- If the host name is registered with an IP address, the server can access the printer using its host name instead of its IP address.

Executing the Installation Shell Script

Having configured the printer IP address, follow the procedure below to execute the installation shell script and set up the workstation printing environment.

★ Important

- Before executing the installation shell script, the IP address, host name, and printer name are required.
- The following procedures use the sample IP address: 192.168.15.16; sample host name: `nphost`; and sample printer name: `np`.
- Download the installation shell script from our Web site. Keep the installation shell script as local folders.

1. Move to the directory that has kept the installation shell script.

2. Run the installation shell script.

```
# sh ./install
```

Insert a period and slash before the current directory.

3. Enter a number to select the workstation operating system that you are using.

```
Network printer install shell
```

```
Select your workstation OS type
```

1. SunOS 4.x.x
2. Solaris 2.x, Solaris 7-9 (SunOS5.x)
3. HP-UX
4. UnixWare
5. Linux
6. OpenServer
7. Quit

Enter <1-7>:

If you select "7", the installation shell script ends.

4. Enter the printer's IP address.

Enter Printer host IP address <xxx.xxx.xxx.xxx> [return=skip]:

192.168.15.16

If the host name of the printer has already been configured, press the [RETURN] ([ENTER]) key. Nothing will be added to the /etc/hosts file.

5. Enter the printer's host name.

Enter Printer host name : nphost

If no IP address was entered in step 4, nothing is added to the /etc/hosts file.

6. Configure the printer name.

Enter logical printer name [default nphost_prn]

If you want to use the default name, press the [RETURN] ([ENTER]) key. Enter a new name, if you want to use a different one.

The host name entered in step 5 followed by "_prn" appears in "default".

7. Set the print option.

Enter remote printer name [default lp]:

- Press the [RETURN] ([ENTER]) key, and printing with PostScript is enabled.
- If you want to set the device option, enter the option parameter.
Enter remote printer name [default lp]:tray=tray1
- If you enter "text", text printing is enabled.
- If you enter "text", printing with PostScript is disabled.

Enter remote printer name [default lp]:text

You can enter up to 14 characters for HP-UX 11.0, 256 for Solaris 8 and Red Hat Linux 7.0, and 51 for Red Hat Linux 6.2.

After setup with the installation shell script is complete, and if you entered the IP address in step 4, the following message appears:

hosts file is modified

8. Perform a test print to make sure that the settings are correct.

```
# lpr -Pnp file_name
```

```
# lp -d np file_name
```

Note

- SunOS, UnixWare, and OpenServer appear on the screen, but they are not supported. Use Solaris, HP-UX, or Linux.
- The IP address will be added to the `/etc/hosts` file.
- The host name will be added to the `/etc/hosts` file.
- When printing with the `lp` command, use (`_`) instead of (`=`) and (`;`) instead of (`,`) for operating systems that cannot use (`=`) and (`,`) such as Solaris 2.5 or later.
- For details about how to download the installation shell script, contact your sales or service representative.
- For details about `lpr` and `lp`, see "Printing Method".
- For details about the device option, see "Specifying the Device Option".

Reference

- p.16 "Printing Method"
- p.21 "Specifying the Device Option"

Deleting the printer

To print using the `lp` or `lpr` command, the option specified when the installation shell script is executed is used. Change the option in accordance with the workstation you are using.

BSD UNIX workstation, Linux

Delete the printer entry from `/etc/printcap`, and then execute the installation shell script again. Select options during the setup process.

Alternatively, search the printer entry from `/etc/printcap`, and change its `rp` capability to option setting.

Solaris, HP-UX

Delete the printer entry, and then execute the installation shell script again.

Select options during the setup process. To delete the printer entry, follow the procedure below:

1. Stop the scheduler.

```
# /usr/sbin/lpshut
```

2. Delete the printer.

```
# /usr/sbin/lpadmin -x printer_name
```

- Restart the scheduler.

```
# /usr/lib/lpsched
```

After Executing the Installation Shell Script

The printing environment is set up automatically when the installation shell script is executed.

This section describes setup contents when the installation shell script is executed under Red Hat Linux, Solaris, and HP-UX.

Linux

Adding the IP address and host name to the `/etc/hosts` file

The following line is added to the `/etc/hosts` file. The IP address and printer host name which you previously entered in the installation script will be used:

```
192.168.15.16 nphost # Network Printer
```

- 192.168.15.16 is the IP address, nphost is the host name, from # to the end of the line is the comment.

Note

- The `/etc/hosts` file contains a list of the IP addresses and host names of all hosts communicating on the network. Each entry is delimited with a space or a tab, and each line is separated with a return.
- If you do not use NIS or DNS, you must manually enter the IP address and host name of each workstation using the network printer in the `/etc/hosts` file.

Adding an entry to the `/etc/printcap` file

The following entry is added to the `/etc/printcap` file, which is the configuration for printing with the `lpr` command. In order to use the `lpr` command to print, you need to edit the `/etc/hosts` file, add an entry for the network printer to the `/etc/printcap` file and create a spool directory:

```
##PRINTTOOL3## REMOTE
np|Network Printer:\
:rm=nphost:\
:rp=option:\
:sd=/var/spool/lpd/npd:\
:lf=/var/log/npd-errs:\
:sh:\
:mx#0:
```

↓ Note

- The `/etc/printcap` file is used to register the name and attributes of a printer. You must make an entry for the network printer in the `/etc/printcap` file of all workstations using the network printer.
- You must make an entry for each printer option when using the same printer.
- Each entry is separated with colons into several fields. The syntax is to begin each entry with a colon, followed by the entry, and then end with a colon, a back slash, and then a return.
- The first line of the field is the name of the printer. You use this name when logging on to a network printer from a workstation. You can define several different names by separating each name with the "|" character.
- The second and following lines contain the printer's attributes. Attributes are represented by two-character names referred to as capabilities. For details about capabilities, see the following table:

Capability	Explanation	Value required for the network printer.
rm	Host name of the printer.	The host name that was registered with the <code>/etc/hosts</code> file.
rp	Optional specification. "lp" will be assigned, if the option is not used.	Select options for printing. For details about available options, see "Specifying the Device Option".
sd	Path name of the spool directory.	Path name of the spool directory that is to be created.
lf	Path name of the log file.	Path name of the log file. For example <code>/var/log/lpd-errs</code> .
mx	Maximum file size which the directory can copy. When set to 0, the size is unlimited. If nothing is entered, the size is set to 1024 k.	None, or something suitable.

📖 Reference

- p.21 "Specifying the Device Option"

Making the spool directory

Create a spool directory under `/var/spool/lpd`. The name of the spool directory should be the name of the printer followed by a "d".

Note

- The spool directory is used to control data used for print jobs. For example, when a print job is created, a temporary copy of the data used is created in the spool directory. All workstations accessing the network printer need to have a spool directory for the network printer.
- A spool directory should be made for every network printer entry listed in the `/etc/printcap` file.
- The spool directory should normally be made under `/var/spool/lpd` and the name should match that listed under the `sd` capability in `/etc/printcap`.
- Change the owner and group of the directory to `root` and `lp`. The following examples show how to make a `/var/spool/lpd/npd` spool directory:

```
# cd /var/spool/lpd
# mkdir npd
# chown root npd
# chgrp lp npd
```

Making the log file

Error messages are logged to a file created in the `/var/log` directory. The log file name is the printer name followed by "d-errs".

Note

- The log file is used for logging errors or warning messages by the UNIX workstation.
- The log file should be made for every network printer entry listed in the `/etc/printcap` file.
- The log file should normally be made under `/var/log` directory and the name should match that listed under the `lf` capability in `/etc/printcap`. Change the owner and group of the log file to `root` and `lp`. The following examples show how to make a `/var/log/npd-errs` file:

```
# cd /var/log
# touch npd-errs
# chown root npd-errs
# chgrp lp npd-errs
```

Solaris

Adding the IP address and host name to the `/etc/hosts` file

The following line is added to the `/etc/hosts` file. The IP address and printer host name previously entered in the installation script will be used.

```
192.168.15.16 nphost # Network Printer
```

- 192.168.15.16 is the IP address, `nphost` is the host name, from `#` to the end of the line is the comment.

Note

- The `/etc/hosts` file contains a list of IP addresses and host names of all hosts communicating on the network. Each entry is delimited with a space or a tab, and each line is separated with a return.
- If you do not use NIS or DNS, you must manually enter the IP address and host name of each workstation using the network printer in the `/etc/hosts` file.

Registering the printer

The installation shell script registers the printer as a remote printer following the procedure below:

1. If your workstation is Solaris 2.5.1, register the print server and print client to the print service.

```
# lpsystem -t bsd -R 0 -y Network Printer nphost
```

2. Register the printer as a remote printer.

```
# lpadmin -p np -s nphost!option -T dump -I any
```

- `np` is the printer name, `nphost` is the host name. For details about "option", see "Specifying the Device Option".

"lp" will be assigned, if the option is not used.

When printing with the `lp` command, use (`_`) instead of (`=`) and (`;`) instead of (`,`) for operating systems that cannot use (`=`) and (`,`) such as Solaris 2.5 or later.

3. If your workstation is Solaris 2.5.1, set the print job to active so it can be accepted by the print queue.

```
/usr/lib/accept np
```

4. If your workstation is Solaris 2.5.1, set the print job to active to print.

```
/usr/lib/enable np
```

Reference

- p.21 "Specifying the Device Option"

HP-UX

Adding the IP address and host name to the `/etc/hosts` file

The following line is added to the `/etc/hosts` file. The IP address and printer host name previously entered in the installation script will be used:

```
192.168.15.16 np # Network Printer
```

- 192.168.15.16 is the IP address, `np` is the host name, from `#` to the end of the line is the comment.

Note

- The `/etc/hosts` file contains a list of IP addresses and host names of all hosts communicating on the network. Each entry is delimited with a space or a tab, and each line is separated with a return.

- If you do not use NIS or DNS, you must manually enter the IP address and host name of each workstation using the network printer in the `/etc/hosts` file.

Registering the printer

The installation shell script registers the printer as a remote printer following the procedure below:

1. Stop the scheduler.

```
/usr/lib/lpshut
```

2. Register the printer.

```
/usr/lib/lpadmin -Pnp -v/dev/null -mrmode1  
-ormnphost -orpooption -ob3
```

- `np` is the printer name, `nphost` is the host name.

For details about "option", see "Specifying the Device Option".

"lp" will be assigned, if the option is not used.

3. Set the printer so the print job is listed in the print queue.

```
/usr/lib/accept np
```

4. Set the printer to perform the print job.

```
/usr/lib/enable np
```

5. Restart the scheduler.

```
/usr/lib/lpsched
```

Reference

- p.21 "Specifying the Device Option"

Printing Method

This section explains how to print documents using commands.

1

Printing with lpr, lp

Execute one of the following commands according to type of workstation used:

BSD UNIX workstation, Linux

```
% lpr -Pprinter_name file_name [file_name...]
```

For example:

The printer name is np, file names are file1 and file2

```
% lpr -Pnp file1 file2
```

Solaris, HP-UX

```
% lp -d printer_name file_name [file_name...]
```

For example:

The printer name is np, file names are file1 and file2

```
% lp -d np file1 file2
```

Windows

```
% lpr -S printer's IP address (printer's host_name) -P printer_name [-o l] \path \file_name
```

To print a binary file, include the "-o l" switch (a dash followed by a lowercase O and L) after the printer name.

For example:

If the printer's IP address is 192.168.0.123, the printer name is np, and the file name is file1 (c:\print\file1.txt):

```
% lpr -S 192.168.0.123 -P np c:\print\file1.txt
```

↓ Note

- "printer_name" is the printer name entered when executing the installation shell script with UNIX.
- You can use wild cards (* or ?) for the file name.
- The message "print session full" appears when the maximum number of print requests has been reached (max. 5 sessions - Job Spool setting available).
- You should try to print again when the number of requests is less than five. You can check the number of print requests using telnet. For details about using telnet, see the manual that comes with this printer.
- The number of print sessions does not change, whether you increase or reduce the printer's total memory size.

Printing with rsh, rcp, ftp

You can also print using the rsh, rcp, and ftp commands.

↓ Note

- Print using a format the printer supports.
- You should try to print again when the number of requests is zero.
- The message "print session full" appears when the maximum number of print requests is reached.
- The maximum number of print sessions varies depending on the command.
- When using the rsh, rcp command, the maximum number of print sessions is 5; when using the ftp command, the number is 3.

rsh

```
% rsh host_name print < file_name
```

For example:

host name is nphost, file name is file1

```
% rsh nphost print < file1
```

↓ Note

- "host_name" is the name entered when executing the installation shell script.
- If you are using HP-UX, use the remsh command instead of rsh.

rcp

To specify and print the file

```
% rcp file_name [file_name...] host_name:
```

For example:

host name is nphost, file names are file1 and file2

```
% rcp file1 file2 nphost:
```

To print all of the files in a directory

```
% rcp -r directory_name host_name:
```

For example:

host name is nphost, directory name is directory

```
% rcp -r directory1 nphost:
```

↓ Note

- "host_name" is the name entered when executing the installation shell script.

- You can use wild cards (* or ?) for the file name.

ftp

Use the put or mput command depending on the number of files to be printed.

★ Important

- File names cannot contain "=", ",", or ";".
- You can use wild cards (* or ?) for the file name with the mput command.

To print one file

```
ftp> put file_name [Option]
```

To print several files

```
ftp> mput file_name [file_name...] [Option]
```

The following procedure shows an example of how to print a file using ftp.

It is not possible to set options with the mput command:

1. Start ftp using the IP address or host name of the printer.

```
% ftp IP_address
```

2. Enter the user name and password, and then press the [RETURN] ([ENTER]) key.

For details about the user name and password, consult your administrator.

```
User:
```

```
Password:
```

3. Set the file transfer mode to binary.

```
ftp> bin
```

If the file transfer mode is not set to binary, the image may not be printed correctly.

4. Print the file.

For example, to print the file named file1:

```
ftp> put \path\file1
```

For example, to print the two files named file1 and file2:

```
ftp> mput \path\file1 \path\file2
```

5. Exit ftp.

```
ftp> bye
```

Printer Status

You can use the following commands to have information and printer status displayed or copied to a file.

Use the `lpq` or `lpstat` command to display the status of the printer or information about print jobs.

Use the `rsh`, `rcp` or `ftp` commands to get more detailed information from the printer.

1

Viewing the Print Job Status with `lpq` and `lpstat`

BSD UNIX workstation, Linux

```
% lpq -Pprinter_name
```

For example: Printer name is np

```
% lpq -Pnp
```

System V UNIX, Solaris, HP-UX

```
% lpstat -o printer_name
```

For example: Printer name is np

```
% lpstat -o np
```

↓ Note

- If you are using HP-UX, do not put a space between "-o" and "printer name".

Viewing the Printer Status with `rsh` and `ftp`

Use the `rsh` or `ftp` command to display printer status or information about print jobs using specified parameters.

You can use these commands for BSD and System V UNIX.

If your workstation is HP-UX, use the `remsh` command instead of `rsh`.

- `rsh`

```
% rsh host_name parameter
```
- `ftp`

```
% ftp host_name
User:
password:
ftp> get parameter -
```

Parameters that can be used with `rsh`, `rcp` and `ftp` :

Parameter	Information returned
stat	Status of the printer. Information about print jobs.
info	Information about the paper tray, output tray and printer language.
prnlog	Record of the last 10 jobs printed.
syslog	Record of messages about the network interface board.

↓ Note

- For details about the user name and password, consult your administrator.
- "-" indicates standard output. Display will be displayed on screen if standard output has not been specified.

Copying Information to a File

Use the rcp or ftp command to copy information about specified parameters to a file.

You can use these commands for BSD and System V UNIX.

★ Important

- The same parameters are used as those above.
 - rcp

```
% rcp host_name:parameter file_name
```
 - ftp

```
% ftp host_name
User:
password:
ftp> get parameter file_name
```

↓ Note

- For details about the user name and password, consult your administrator.

Specifying the Device Option

With the following options, you can print with specific printer functions.

This manual covers all models, and therefore contains functions and settings that may not be available for your model.

Configuring the Device Option

★ Important

- The optional character strings the printer can recognize contain a maximum of 512 bytes.
- The number of available characters used as options is limited, depending on operating systems.

The configuration of the print option varies, depending on printing commands.

- rsh

```
% rsh host_name print option1=value1,... < file_name
```
- rcp

```
% rcp file_name host_name:option1=value1,...
```
- ftp

```
ftp> put file_name option1=value1,...
```

Host_name is the printer host name. File_name is the file name you want to print.

The device option is specified in the form of "option=value". For details about types of device options and values, see the following explanations.

For example, the following settings are for printing with rsh, rcp, and ftp : switch to PostScript, feed paper from paper feed tray 1, set the printing amount to 3 sets, and print with the resolution set to 600 dpi (host_name :nphost, file_name :file1).

- rsh

```
% rsh nphost print filetype=postscript,tray=tray1,copies=3,resolution=600 < file1
```
- rcp

```
% rcp file1 nphost:filetype=postscript,tray=tray1,copies=3,resolution=600
```
- ftp

```
ftp> put file1 filetype=postscript,tray=tray1,copies=3,resolution=600
```

↓ Note

- Multiple options must be separated by commas (,). Do not use spaces.
- When the printing file contains the PostScript commands control of the option, the command takes priority.

- Enter the option using the lp or lpr command, when the shell script is implemented.
- The option settings made here are configured as default. You must create another printer if you want to change printer option settings. For details about changing the configured option, see "Executing the Installation Shell Script".
- When printing with the lp command, use (_) instead of (=) and (;) instead of (,) for operating systems that cannot use (=) and (,) such as Solaris 2.5 or later.

Reference

- p.8 "Executing the Installation Shell Script"

Using the cd command with ftp

For printing with ftp, if the option is specified using the cd command, it becomes available whenever the put or mput command is used.

```
ftp> cd option
```

Note

- The pwd command shows the current option settings.

```
ftp> pwd
```

List of the device options

Device option	Value	Function summary.
filetype	pcl, postscript (rps), pdf	Specifies the printer language for printing.
filter	text	Specifies the text printing.
tray	tray1 - tray5, bypass, all	Specifies the input tray.
paper	a4, a5, a6, jisb5, jisb6, legal, letter, halfletter, executive, fgl, foolscap, folio, com10, c5, c6, dl, monarch, k16, custom	Specifies the paper size.

Device option	Value	Function summary.
mediatype	plainorrecycled, plain, recycled, special, special2, special3, thick, thick2, thick3, thick4, thin, transparency, color, letterhead, preprinted, labels, bond, cardstock, middlethick, envelope, glossycoated, thickglossycoated, matcoated, thickmatcoated, waterproof, custom1, custom2, custom3, custom4, custom5, custom6, custom7, custom8, auto	Specifies the paper type.
outbin	upper	Specifies the output tray.
copies	Number of copies (1-999)	Specifies the number of copies to print.
qty	Number of collated sets (1-999)	Specifies the number to collate.
duplex	on, off	Specifies whether duplex printing is on or off.
binding	longedge, shortedge, left, right, top	Specifies the binding direction for duplex printing.
orientation	portrait, landscape	Specifies the feed direction of the paper.
image direction	normal, reverse	Specifies the print image rotation.
resolution	value of resolution (300, 600, 1200)	Specifies the resolution for printing.
bitsperdot	1, 2	Specifies the print quality.
billing code	Value of billing code (0x09 (<HT>), 0x20-0xFF (except 0x22))	Specifies the billing code.
usercode	Value of usercode (specifies the user codes using up to eight digits)	Specifies the usercode.

Device option	Value	Function summary.
symbol set	arabic8, desktop, greek8, hebrew7, hebrew8, iso4, iso6, iso11, iso15, iso17, iso21, iso60, iso69, isocyr, isogr, isoheb, isol1, isol2, isol5, isol6, isol9, legal, math8, mctext, mspubl, pc8, pc775, pc850, pc851, pc852, pc858, pc862, pc864, pc866, pc866u, pc1004, pc8dn, pc8grk, pc8tk, pifont, psmath, pstext, roman8, roman9, ucs2, win30, winarb, winbaltic, wincyr, wingrk, winl1, winl2, winl5	Specify the set of print characters.

↓ Note

- The value or actions that can be selected differ depending on the model you are using. For details about available value, see the manual that comes with this printer.

Printer Language

Select a printer language to be used.

```
filetype=printer language
```

```
fil=printer language
```

Printer language	Value
PCL 5c or PCL 5e	pcl
PostScript 3	postscript or rps
PDF	pdf

The following sample shows how to print with PostScript 3 (host name: nphost, file name: file1):

- rsh
% rsh nphost print filetype=postscript < file1
- rcp
% rcp file1 nphost:filetype=postscript

- ftp
ftp> put file1 filetype=postscript

Text Printing

Set this function when printing text files directly.

filter=text

The following sample shows how to print text files directly.

- rsh
% rsh nphost print filter=text < file1
- rcp
% rcp file1 nphost:filter=text
- ftp
ftp> put file1 filter=text

Input Tray

Select a default input tray.

tray=value of input tray

Input tray	Value
Tray 1	tray1
Tray 2	tray2
Tray 3	tray3
Tray 4	tray4
Tray 5	tray5
Bypass tray	bypass
Auto Tray Select	all

The following sample shows how to print from tray 2 (host name: nphost, file name: file1):

- rsh
% rsh nphost print tray=tray2 < file1
- rcp

```
% rcp file1 nphost:tray=tray2
```

- ftp

```
ftp> put file1 tray=tray2
```

↓ Note

- The value or actions that can be selected differ depending on the model you are using. For details about available tray, see the manual that comes with this printer.

Paper Size

Select the paper size.

paper=value of paper size

Paper size	Value
A4	a4
A5	a5
A6	a6
B5JIS (Japanese Industrial Standard)	jisb5
B6JIS	jisb6
8 ¹ / ₂ × 14	legal
8 ¹ / ₂ × 11	letter
5 ¹ / ₂ × 8 ¹ / ₂	halfletter
7 ¹ / ₄ × 10 ¹ / ₂	executive
8 × 13	fgl
8 ¹ / ₂ × 13	foolscap
8 ¹ / ₄ × 13	folio
4 ¹ / ₈ × 9 ¹ / ₂	com10
6.38 × 9.02 (162 × 229 mm)	c5
4.49 × 6.38 (114 × 162 mm)	c6
4.33 × 8.66 (110 × 220 mm)	dl

Paper size	Value
$3\frac{7}{8} \times 7\frac{1}{2}$	monarch
7.68×10.5 (195 × 267 mm)	k16
Custom size	custom

The following sample shows how to print using A4 size paper (host name: nphost, file name: file1):

- rsh
% rsh nphost print paper=a4 < file1
- rcp
% rcp file1 nphost:paper=a4
- ftp
ftp> put file1 paper=a4

Note

- The value or actions that can be selected differ depending on the model you are using. For details about available paper size, see the manual that comes with this printer.

Paper Type

Select the paper type.

mediatype=value of paper type

Paper type	Value
Plain paper/recycled paper	plainorrecycled
Plain paper	plain
Recycled paper	recycled
Special paper	special
	special2
	special3

1

Paper type	Value
Thick paper	thick
	thick2
	thick3
	thick4
Thin Paper	thin
OHP transparency	transparency
Color paper	color
Letterhead	letterhead
Preprinted paper	preprinted
Labels	labels
Bond paper	bond
Cardstock	cardstock
Middle thick	middlethick
Envelope	envelope
Coated Paper (Glossy)	glossycoated
Coated Paper (Glossy : Thick)	thickglossycoated
Coated Paper (Matted)	matcoated
Coated Paper (Matted : Thick)	thickmatcoated
Waterproof Paper	waterproof

Paper type	Value
Custom Paper	custom1
	custom2
	custom3
	custom4
	custom5
	custom6
	custom7
	custom8
Auto Paper Select	auto

The following sample shows how to print using recycled paper (host name: nphost, file name: file1):

- rsh
% rsh nphost print mediatype=recycled < file1
- rcp
% rcp file1 nphost:mediatype=recycled
- ftp
% ftp> put file1 mediatype=recycled

↓ Note

- The value or actions that can be selected differ depending on the model you are using. For details about available paper type, see the manual that comes with this printer.

Output Tray

Select the output tray.

outbin=value of output tray

Value
upper

The following sample shows how to print to the standard tray (standard tray: upper, host name: nphost, file name: file1):

- rsh
% rsh nphost print outbin=upper < file1
- rcp
% rcp file1 nphost:outbin=upper
- ftp
ftp> put file1 outbin=upper

Copies

Specify the number of copies.

copies=number of copies (1 to 999)

★ Important

- **Do not specify "copies" and "qty *1" commands at the same time.**
*1 "qty" specifies the number of collated sets.

The following sample shows how to print 10 copies (host name: nphost, file name: file1):

- rsh
% rsh nphost print copies=10 < file1
- rcp
% rcp file1 nphost:copies=10
- ftp
ftp> put file1 copies=10

Collating

Specify the number of collated sets.

qty=number of collated sets (1 to 999)

The following sample shows how to print 10 copies using the collate function (host name: nphost, file name: file1):

- rsh
% rsh nphost print qty=10 < file1
- rcp
% rcp file1 nphost:qty=10
- ftp
ftp> put file1 qty=10

Duplex Printing

This option enables duplex printing.

★ Important

- **The duplex unit is required.**

duplex=value of duplex printing

Duplex printing	Value
enable	on
disable	off

The following sample shows how to set duplex printing (host name: nphost, file name: file1):

- rsh
% rsh nphost print duplex=on,binding=longedge < file1
- rcp
% rcp file1 nphost:duplex=on,binding=longedge
- ftp
ftp> put file1 duplex=on,binding=longedge

↓ Note

- Before selecting duplex, the binding option must be set to on.
- Data and paper volume affect the completion of the print job.
- For details about available paper size for duplex printing, see the manual that comes with this printer.

Binding

Select the binding direction for duplex printing.

★ Important

- **The duplex unit is required.**

binding=value of binding

Binding direction	Value
Longedge	longedge
Shortedge	shortedge

Binding direction	Value
Left	left
Right	right
Top	top

The following sample shows how to set duplex printing and long-edge binding (host name: nphost, file name: file1):

- rsh
% rsh nphost print duplex=on,binding=longedge < file1
- rcp
% rcp file1 nphost:duplex=on,binding=longedge
- ftp
ftp> put file1 duplex=on,binding=longedge

↓ Note

- Before selecting the binding option, the duplex option must be set to on.
- Data and paper volume affect completion of the print job.

Orientation

Select the paper feed orientation.

★ Important

- **This function is only for PCL.**

orientation=feed direction (portrait or landscape)

Orientation	value
Portrait	portrait
Landscape	landscape

The following sample shows how to print the paper vertically using the orientation function (host name : nphost, file name : file1):

- rsh
% rsh nphost print orientation=portrait < file1
- rcp

```
% rcp file1 nphost:orientation=portrait
```

- ftp

```
ftp> put file1 orientation=portrait
```

Image Direction

Select the print image rotation.

imagedirection=value of print image rotation

Rotation	Value
0 degree	normal
180 degrees	reverse

The following sample shows how to print the 180 degrees rotation using the imagedirection function (host name : nphost, file name : file1):

- rsh

```
% rsh nphost print imagedirection = reverse < file1
```

- rcp

```
% rcp file1 nphost: imagedirection = reverse
```

- ftp

```
ftp> put file1 imagedirection = reverse
```

Resolution

Select the printing resolution.

resolution=value of resolution

Resolution	Value
1200 dpi	1200
600 dpi	600
300 dpi	300

The following sample shows how to print with 600 dpi and better quality. (host name: nphost, file name: file1):

- rsh
% rsh nphost print resolution=600 < file1
- rcp
% rcp file1 nphost:resolution=600
- ftp
ftp> put file1 resolution=600

↓ Note

- The value or actions that can be selected differ depending on the model you are using. For details about available resolution, see the manual that comes with this printer.

Gradation Quality

Select this option to improve print quality.

★ Important

- **Before you can select the `bitsperdot` option, the printer language must be set to PostScript 3 and the resolution must be set to 600 dpi.**

`bitsperdot=value` of gradation quality

Gradation quality	Value
Fine	2
Standard	1

The following sample shows how to print with 600 dpi and the fine quality. (host name: nphost, file name: file1):

- rsh
% rsh nphost print filetype=postscript,resolution=600,bitsperdot=2 < file1
- rcp
% rcp file1 nphost:filetype=postscript,resolution=600,bitsperdot=2
- ftp
ftp> put file1 filetype=postscript,resolution=600,bitsperdot=2

↓ Note

- The value or actions that can be selected differ depending on the model you are using. For details about available gradation quality, see the manual that comes with this printer.

Billing Code

Specify the billing code.

billingcode=Value of billingcode (0x09(<HT>), 0x20-0xFF (except 0x22)) *1

*1 MAX 228 bytes = 255byte (Max number of characters allowed for each PJI command line on GW-PJI source)
- 27 bytes (number of characters for @PJI SET BILLINGCODE = ""<CR><LF>)

- rsh
% rsh nphost print billingcode=0x09 < file1
- rcp
% rcp file1 nphost: billingcode=0x09
- ftp
ftp> put file1 billingcode=0x09

↓ Note

- Note that PJI syntax allows any number of spaces to be entered. For example, multiple spaces can be inserted between "@PJI" and "SET", or before and after the "=" sign.
- Therefore, a password can be less than the maximum value (228 bytes).
- This also implies the maximum value (228 bytes) is secured as long as the normal syntax is used.

Usercode

Specify the usercode.

Usercode=\"value of usercode\"

The usercode must be specified using up to eight digits.

The usercode must be inside double quotation marks (" ").

Some operating systems cannot forward the usercode if it is inside double quotation marks. If this is the case, include escape characters such as back slashes (\) (0x5c) in place of double quotation marks.

- rsh
% rsh nphost print usercode=\"12345\" < file1
- rcp
% rcp file1 nphost: usercode=\"12345\"
- ftp
ftp> put file1 USERCODE=\"12345\"

↓ Note

- If you are printing with the ftp command, enter the usercode in uppercase letters.

Symbol Set

Select the set of print characters for the chosen font.

★ Important

- This function is only for PCL.

symset=value of font

Symbol Set	Value
Arabic-8	arabic8
Desktop	desktop
Greek-8	greek8
Hebrew-7	hebrew7
Hebrew-8	hebrew8
ISO 4	iso4
ISO 6	iso6
ISO 11	iso11
ISO 15	iso15
ISO 17	iso17
ISO 21	iso21
ISO 60	iso60
ISO 69	iso69
ISO Cyrillic	isocyr
ISO Greek	isogrkr
ISO Hebrew	isoheb
ISO L1	isol1
ISO L2	isol2
ISO L5	isol5
ISO L6	isol6

Symbol Set	Value
ISO L9	isol9
Legal	legal
Math-8	math8
MC Text	mctext
MS Publ	mspubl
PC-8	pc8
PC-775	pc775
PC-850	pc850
PC-851	pc851
PC-852	pc852
PC-858	pc858
PC-862	pc862
PC-864	pc864
PC-866	pc866
PC-866U	pc866u
PC-1004	pc1004
PC-8 D/N	pc8dn
PC-8 Greek	pc8grk
PC8-TK	pc8tk
Pifont	pifont
PS Math	psmath
PS Text	pstext
Roman-8	roman8
Roman-9	roman9
UCS-2	ucs2

Symbol Set	Value
Win 3.0	win30
Win Arabic	winarb
Win Baltic	winbaltic
Win Cyrillic	wincyr
Win Greek	wingrk
Win L1	winl1
Win L2	winl2
Win L5	winl5

The following sample shows how to print the ISO 4 character set (host name : nphost, file name : file1):

- rsh
% rsh nphost print symset=iso4 < file1
- rcp
% rcp file1 nphost:symset=iso4
- ftp
ftp> put file1 symset=iso4

2. Remote Maintenance Using telnet

This chapter explains the commands and functions you can use to manage the printer by telnet.

Using telnet

Follow the procedure below to use telnet.

2

★ Important

- Remote Maintenance should be password-protected so that access is allowed to administrators only.
- The password is the same as the one of Web Image Monitor administrator. When the password is changed using "mshell", other passwords change also.
- Some commands cannot be used depending on your printer.
- Only one user at a time can log in to perform remote maintenance.
- If you are using Windows Vista/7 or Windows Server 2008/2008 R2 you must enable the telnet server and telnet client beforehand.

1. Use the IP address or the host name of the printer to start telnet.

```
% telnet "IP_address"
```

2. Enter your user name and password.

Contact your administrator for information about the settings.

3. Enter a command.

4. Quit telnet.

```
msh> logout
```

A message asking you to confirm saving the changes appears.

5. Enter "yes" to save the changes, and then press the [RETURN] ([ENTER]) key.

If you do not want to save the changes, enter "no", and then press the [RETURN] ([ENTER]) key. To make further changes, enter "return" at the command line, and then press the [RETURN] ([ENTER]) key.

↓ Note

- If the message "Can not write NVRAM information" appears, the changes are not saved. Repeat the procedure above.
- When the changes are saved, the network interface board is reset automatically with that changes.
- When the network interface board resets, the print job in print process will be printed. However, print jobs in queue will be canceled.

8021x

Use the "8021x" commands to display IEEE 802.1x related information.

View settings

```
msh> 8021x
```

Configuration

```
msh> 8021x "parameter"
```

Parameter	Value configured
eap {tls ttls leap peap} {chap mschap mschapv2 pap md5 tls}	<p>You can specify the EAP authentication type.</p> <p>tls: EAP-TLS (default)</p> <p>ttls: EAP-TTLS</p> <p>leap: LEAP</p> <p>peap: PEAP</p> <p>chap, mschap, mschapv2, pap, md5, and tls are settings for the phase 2 method, and one of these must be specified if EAP-TTLS or PEAP is selected.</p> <p>Do not make these settings when using other EAP authentication types.</p> <p>If you select EAP-TTLS, you can select chap, mschap, mschapv2, pap, or md5.</p> <p>If you select PEAP, you can select mschapv2 or tls.</p>
username "character string"	<p>You can specify the login user name for the Radius server.</p> <p>Usable characters: ASCII 0x20-0x7e (31 bytes).</p> <p>The default is blank.</p>
username2 "character string"	<p>You can specify the phase 2 username for EAP-TTLS/PEAP phase 2 authentication.</p> <p>Usable characters: ASCII 0x20-0x7e (31 bytes).</p> <p>The default is blank.</p>

Parameter	Value configured
domain "character string"	You can specify the login domain name for the Radius server. The characters you can enter are ASCII 0x20-0x7e (64 bytes), but not "@" or "\". The default is blank.
password "character string"	You can specify the login password for the Radius server. Usable characters: ASCII 0x20-0x7e (128 bytes). The default is blank.
svrcert {on off}	You can set the server certificate. The default is "off".
imca {on off}	You can enable or disable the certificate when the intermediate certificate authority is present. The default is "off".
srvld "character string"	You can set the server ID and sub domain of the certificate server. Usable characters: ASCII 0x20-0x7e (128 bytes). The default is blank.
clear {a each command all}	Returns the selected setting to its default value. If you specify "all", all settings will be restored to their default values. However, IEEE 802.1x Auth. status (enable or disable) for Ethernet and Wireless LAN will not be initialized.

access

Use the "access" command to view and configure access control. You can also specify two or more access ranges.

View settings

```
msh> access
```

IPv4 configuration

```
msh> access [X] range "start-address end-address"
```

- [X] represents a target number between 1 and 5. (Up to five access ranges can be registered and selected.)

Example: to specify accessible IPv4 addresses between 192.168.0.10 and 192.168.0.20:

```
msh> access 1 range6 192.168.0.10 192.168.0.20
```

IPv6 configuration

```
msh> access [X] range6 "start-address end-address"
```

- [X] represents a target number between 1 and 5. (Up to five access ranges can be registered and selected.)

Example: to specify accessible IPv6 addresses between 2001:DB8::100 and 2001:DB8::200.

```
msh> access 1 range6 2001:DB8::100 2001:DB8::200
```

IPv6 access mask configuration

```
msh> access [X] mask6 "base-address prefixlen"
```

- [X] represents a target number between 1 and 5. (Up to five access ranges can be registered and selected.)

Example: to specify accessible IPv6 addresses to 2001:DB8::/32

```
msh> access 1 mask6 2001:DB8:: 32
```

Access control initialization

```
msh> access flush
```

- Use the "flush" command to restore the default settings so that all access ranges become "0.0.0.0" for IPv4, and "::" for IPv6.

Note

- The access range restricts computers from use of the printer by IP address. If you do not need to restrict printing, make the setting "0.0.0.0" for IPv4, and "::" for IPv6.
- Valid ranges must be from lower (start address) to higher (end address).
- If you are running IPv4 or IPv6, up to five access ranges can be registered and selected.
- IPv6 can register and select the range and the mask for each access ranges.
- IPv6 mask ranges between 1 - 128 can be selected.
- Up to five access ranges can be specified. The entry is invalid if the target number is omitted.
- You cannot send print jobs, or access Web Image Monitor and diprint from a restricted IP address.

authfree

Use the "authfree" command to view and configure authfree parameters.

View settings

The following command displays the current authfree settings:

```
msh> authfree
```

- If print job authentication exclusion is not set, authentication exclusion control cannot be displayed.

IPv4 address settings

```
msh> authfree "ID" range_addr1 range_addr2
```

IPv6 address settings

```
msh> authfree "ID" range6_addr1 range6_addr2
```

IPv6 address mask configuration

```
msh> authfree "ID" mask6_addr1 masklen
```

Parallel/USB settings

```
msh> authfree [parallel | usb] [on|off]
```

- To enable authfree, set to on. To disable authfree, set to off. Always specify the interface.

Authentication exclusion control initialization

```
msh> authfree flush
```

autonet

Use the "autonet" command to view and configure AutoNet parameters.

View settings

The following command displays the current AutoNet settings:

```
msh> autonet
```

Configuration

You can configure AutoNet settings.

```
msh> autonet {on|off}
```

- {on} means "active" and {off} means "inactive".

Current interface priority configuration display

```
msh> autonet priority
```

Interface priority configuration

```
msh> autonet priority "interface_name"
```

- You can give interface's AutoNet parameter priority.
- Priority settings are available when multiple interfaces are installed.
- wlan can be specified only when the Wireless LAN interface unit is installed.

Interface name	Interface configured
ether	Ethernet interface

Interface name	Interface configured
wlan	Wireless LAN interface

↓ Note

- If an interface is not selected, the current interface connection settings remain in effect.

2

bonjour

Use the "bonjour" command to display bonjour-related settings.

View settings

Bonjour settings are displayed.

```
msh> bonjour
```

Bonjour service name setting

You can specify the bonjour service name.

```
msh> bonjour cname "computer name"
```

- The computer name can be entered using up to 63 alphanumeric characters.

Bonjour Installation location information setting

You can enter information about the location where the printer is installed.

```
msh> bonjour location "location"
```

- Information about the location can be entered using up to 32 alphanumeric characters.

Setting order of priority for each protocol

- dprint

```
msh> bonjour dprint [0-99]
```

- lpr

```
msh> bonjour lpr [0-99]
```

- ipp

```
msh> bonjour ipp [0-99]
```

You can specify the order of priority for "dprint", "lpr", and "ipp". Smaller numbers indicate higher priority.

IP TTL setting

```
msh> bonjour ip ttl {1-255}
```

You can specify the IP TTL (the number of routers a packet can pass through).

↓ Note

- The default is 255.

Resetting the computer name and location information

You can reset the computer name and location information.

```
msh> bonjour clear {cname | location}
```

- **cname**
Reset the computer name. The default computer name will be displayed when the computer is restarted.
- **location**
Reset the location information. The previous location information will be deleted.

Interface configuration

```
msh> bonjour linklocal "interface_name"
```

- If many types of interface are installed, configure the interface that communicates with linklocal address.
- If you do not specify an interface, the Ethernet interface is automatically selected.
- wlan can be specified only when the Wireless LAN interface unit is installed.

Interface	Interface configured
ether	Ethernet interface
wlan	Wireless LAN interface

Setting IPP-SSL printing

```
msh> bonjour ippport {ipp|ssl}
```

- If IPP-SSL Printing is set to ssl, the IPP port number will appear as 443, and IPP-SSL printing can be performed with higher security.
- If IPP-SSL Printing is set to ipp, the IPP port number will appear as 631. Port 631 is the port for normal IPP printing.

devicename

Use the "devicename" command to display and change the printer name.

View settings

```
msh> devicename
```

Printer name configuration

```
msh> devicename name "string"
```

- Enter a printer name using up to 31 alphanumeric characters.
- Set single names for each printer.

Printer name initialization

```
msh> device name clearname
```

- Reset the printer name to its default.

2

dhcp

Use the "dhcp" command to configure DHCP settings.

View settings

The following command displays the current DHCP settings.

```
msh> dhcp
```

Configuration

You can configure DHCP.

```
msh> dhcp "interface_name" {on|off}
```

- Click {on} to enable DHCP. Click {off} to disable DHCP.
- If the DNS server address and domain name are obtained from DHCP, be sure to click {on}.
- wlan can be specified only when the Wireless LAN interface unit is installed.

Interface name	Interface configured
ether	Ethernet interface
wlan	Wireless LAN interface

Current interface priority configuration display

```
msh> dhcp priority
```

Interface priority configuration

```
msh> dhcp priority "interface_name"
```

- You can select which interface has DHCP parameter priority.
- Priority settings are available when multiple interfaces are installed.

DNS server address selection

```
msh> dhcp dnsaddr {dhcp | static}
```

- Specify whether to obtain the DNS server address from the DHCP server or use the address set by a user.
- To obtain the DNS server address from the DHCP server, specify "dhcp". To use the address set by a user, specify "static".

Domain name selection

```
msh> dhcp domainname {dhcp | static}
```

- Specify whether to obtain the domain name from the DNS server or use the domain name set by a user.
- To obtain the domain name from the DHCP server, specify "dhcp". To use the domain name set by a user, specify "static".

dhcp6

Use the "dhcp6" command to display or configure DHCPv6 settings.

View settings

The following command displays the current DHCPv6 settings.

```
msh> dhcp6
```

DHCPv6-lite configuration and display

```
msh> dhcp6 "interface_name" lite {on|off}
```

Viewing and specifying DNS server address selection (obtained from the dhcpv6 server/user specified value)

```
msh> dhcp6 dnsaddr {dhcp|static}
```

DUID(DHCP unique ID) deletion and display

```
msh> dhcp6 duid clear
```

Viewing and specifying the time required to re-obtain the parameter obtained from dhcpv6

```
msh> dhcp6 option lifetime [0-65535]
```

- It can be entered between 0 and 65535 minutes.
- The default is 60 minutes.
- If you specify "0", you cannot re-obtain the value.

diprint

The direct printing port enables direct printing from a network-connected computer.

Use the "diprint" command to change direct printing port settings.

View settings

The following command displays the current direct printing port settings:

```
msh> diprint
```

Example output:

```
port 9100
```

```
timeout=300(sec)
bidirect on
conn multi
apl async
```

- The "port" specifies the port number of the direct printing port.
- The "bidirect" setting indicates whether the direct printing port is bidirectional or not.

Setting timeout

```
msh> diprint timeout [30-65535]
```

- You can specify the timeout interval to use when the printer is expecting data from the network.
- The default is 300 seconds.

Specifying the number of concurrent connections

```
msh> diprint conn {multi|single}
```

- The above command specifies the number of concurrent diprint connections. Specify "multi" for multiple connections or "single" for a single connection.
- The default is "multi".

dns

Use the "dns" command to configure or display DNS (Domain Name System) settings.

View settings

The following command displays the current DNS settings:

```
msh> dns
```

IPv4 DNS server configuration

The following command enables or disables the IPv4 DNS server address:

```
msh> dns "number" server "server address"
```

The following command displays a configuration using the IP address 192.168.15.16 on a DNS 1 server:

```
msh> dns 1 server 192.168.15.16
```

- You can register IPv4 DNS Server address.
- You can register up to three IPv4 DNS server numbers.
- You cannot use "255.255.255.255" as the DNS server address.

IPv6 DNS server configuration

The following command enables or disables the IPv6 DNS server address:

```
msh> dns "number" server6 "server address"
```

- You can register IPv6 DNS Server address.
- You can register up to three IPv6 DNS server numbers.

Dynamic DNS function setting

```
msh> dns "interface_name" ddns {on|off}
```

- You can set the dynamic DNS function "active" or "inactive".
- {on} means "active" and {off} means "inactive".
- wlan can be specified only when the Wireless LAN interface unit is installed.

Interface name	Interface configured
ether	Ethernet interface
wlan	Wireless LAN interface

Specifying the record overlap operation

```
msh> dns overlap {update|add}
```

- You can specify operations performed when records overlap.
- update
To delete old records and register new records.
- add
To add new records and store the old records.
- When CNAME overlaps, it is always changed, irrespective of the setting.

CNAME registration

```
msh> dns cname {on|off}
```

- You can specify whether to register CNAME.
- {on} means "active" and {off} means "inactive".
- The CNAME registered is the default name beginning with rnp. CNAME cannot be changed.

A records registration

```
msh> dns arecord {dhcp|own}
```

- {dhcp}
You can specify the method of registering an A record when the dynamic DNS function is enabled and DHCP is used.
- {own}
To register an A record using the printer as the DNS client.
The DNS server address and the domain name already designated are used for the registration.

Record updating interval settings

```
msh> dns interval "time"
```

- You can specify the interval after which records are updated when using the dynamic DNS function.
- The updating interval is specified hourly. It can be entered between 1 and 255 hours.
- The default is 24 hours.

resolv.conf display

```
msh> dns resolv
```

Specifying the protocol when asking names during dual stacking

```
msh> dns resolv protocol {ipv4|ipv6}
```

- Appears during dual stacking only.

domainname

Use the "domainname" command to display or configure the domain name settings.

You can configure the Ethernet interface or Wireless LAN interface.

View settings

The following command displays the current domain name:

```
msh> domainname
```

Interface domain configuration

```
msh> domainname "interface_name"
```

Setting the domain name

```
msh> domainname "interface_name" name "domain name"
```

- A domain name can be entered using up to 63 alphanumeric characters.
- The Ethernet interface and Wireless LAN interface will have the same domain name.
- wlan can be specified only when the Wireless LAN interface unit is installed.

Interface	Interface set
ether	Ethernet interface
wlan	Wireless LAN interface

Deleting the domain name

```
msh> domainname "interface_name" clear "name"
```

etherauth

Use the "etherauth" command to display or modify the authentication related parameters for Ethernet.

View settings

```
msh> etherauth
```

802.1x configuration

```
msh> etherauth 8021x {on|off}
```

- {on} means "active" and {off} means "inactive".

etherconfig

Use the "etherconfig" command to view and configure the Ethernet parameters.

View settings

```
msh> etherconfig
```

Specify Ethernet Speed

```
msh> etherconfig speed {auto|10f|10h|100f|100h}
```

- auto = Auto Select
- 10f = 10 Mbps Full Duplex
- 10h = 10 Mbps Half Duplex
- 100f = 100 Mbps Full Duplex
- 100h = 100 Mbps Half Duplex

The default is "auto".

help

Use the "help" command to display the available command list and the procedures for using those commands.

Command list display

```
msh> help
```

Display of procedure for using commands

```
msh> help "command_name"
```

hostname

Use the "hostname" command to change the printer name.

View settings

```
msh> hostname
```

IPv4 Configuration

```
msh> hostname "interface_name" "printer_name"
```

- Enter the printer name using up to 63 alphanumeric characters.
- You cannot use a printer name starting with "RNP" or "rnp".
- The Ethernet interface and Wireless LAN interface will have the same printer name.
- wlan can be specified only when the Wireless LAN interface unit is installed.
- If you do not specify an interface, the Ethernet interface is selected automatically.

Interface name	Interface configured
ether	Ethernet interface
wlan	Wireless LAN interface

Initializing the printer name for each interface

```
msh>hostname "interface_name" clear "name"
```

ifconfig

Use the "ifconfig" command to view and configure TCP/IP (IP address, subnet mask, broadcast address, default gateway address) for the printer.

View settings

```
msh> ifconfig
```

IPv4 configuration

```
msh> ifconfig "interface_name" "parameter" "address"
```

- If you did not enter an interface name, it is automatically set to the Ethernet interface.
- wlan can be specified only when the Wireless LAN interface unit is installed.

Interface name	Interface configured
ether	Ethernet Interface
wlan	Wireless LAN Interface

The following explains how to configure an IPv4 address 192.168.15.16 on the Ethernet interface.

```
msh> ifconfig ether 192.168.15.16
```

IPv6 configuration

```
msh> ifconfig ether inet6 "interface_name" "prefixlen"
```

The following explains how to configure an IPv6 address to 2001:DB8::100 with prefix length 64 on the Ethernet interface.

```
msh> ifconfig ether inet6 2001:DB8::100 64
```

Netmask configuration

```
msh> ifconfig "interface_name" netmask "address"
```

The following explains how to configure a subnet mask 255.255.255.0 on the Ethernet interface.

```
msh> ifconfig ether netmask 255.255.255.0
```

Broadcast address configuration

```
msh> ifconfig "interface_name" broadcast "address"
```

Changing the interface

```
msh> ifconfig "interface" up
```

You can specify either the Ethernet interface or Wireless LAN interface when using the optional Wireless LAN interface unit is installed.

Note

- To get the above addresses, contact your administrator.
- Use the default configuration if you cannot obtain setting addresses.
- The IP address, subnet mask and broadcast address are the same as that for the Ethernet interface and Wireless LAN interface.
- TCP/IP configuration is the same for both the Ethernet and Wireless LAN interface. If interfaces are changed, the new interface inherits the configuration.
- Use "0x" as the initial two letters of a hexadecimal address.

info

Use the "info" command to display the printer information such as paper tray, output tray, and printer language.

Printer information display

```
msh> info
```

Note

- For details about displayed contents, see "Getting Printer Information over the Network".

Reference

- p.79 "Getting Printer Information over the Network"

ipds

Use the "ipds" command to view and configure the ipds settings.

Viewing settings

The following command displays the current ipds settings:

```
msh> ipds
```

Changing ipds port number

```
msh> ipds port [1024-65535]
```

- The default is 5001.

Note

- Cannot use the port number of the 2501, 2601, and 9100.

Setting timeout

```
msh> ipds timeout [30-65535]
```

- The timeout function is disabled by default.

ipsec

Use the "ipsec" command to view and configure the IPsec settings.

Viewing settings

The following command displays the current IPsec settings:

```
msh> ipsec
```

ipp

Use the "ipp" command to view and configure the IPP settings.

Viewing settings

The following command displays the current IPP settings:

```
msh> ipp
```

IPP timeout configuration

Specify how many seconds the computer waits before canceling an interrupted print job. The time can be entered between 30 to 65535 seconds.

```
msh> ipp timeout [30 - 65535]
```

IPP user authorization configuration

Use IPP user authorization to restrict users to print with IPP. The default is "off".

```
msh> ipp auth {basic|digest|off}
```

- User authorization settings are "basic" and "digest".
- Use "off" to remove a user's authorization.
- If user authorization is specified, register a user name. You can register up to 10 users.

IPP user configuration

Configure IPP users according to the following messages:

```
msh> ipp user
```

The following message appears:

```
msh> Input user number (1 to 10):
```

Enter the number, user name, and password.

```
msh> IPP user name:user1
```

```
msh> IPP password:*****
```

After configuring the settings, the following message appears:

```
User configuration changed.
```

ipv6

Use the "ipv6" command to display and configure the IPv6 settings.

View setting

```
msh> ipv6
```

IPv6 stateless address

```
msh> ipv6 stateless {on|off}
```

If "on" is selected, IPv6 requests information required for maintaining stateful connection to the router for as long as the printer power is turned on. This setting allows information from the router to be obtained constantly, and periodically refreshes the effective period of the stateless address.

logout

Use the "logout" command to save the changes and quit telnet.

Quit telnet

```
msh> logout
```

A confirmation message appears.

```
{yes|no|return}
```

Enter [yes], [no] or [return] by typing the word, and then press the [Enter] key.

To save the changes and quit telnet, enter [yes].

To discard the changes and quit telnet, enter [no].

To continue making changes, enter [return]

lpr

2

Use the "lpr" command to view and configure the LPR settings.

View setting

```
msh> lpr
```

Checking host name when deleting the job

```
msh> lpr chkhost {on|off}
```

If "on" is selected, you can delete print jobs only from the IP address of the host that sent the print job.

If LPR is disabled, you can also delete print jobs sent from IP addresses other than that of the host.

Printer Error Detection Function

```
lpr pnerrchk {on|off}
```

If you set this to "on", the printer stops receiving data and will wait until the error is resolved before continuing processing a job.

netware

Use the "netware" command to configure the NetWare settings such as the print server name or file server name.

NetWare printer server names

```
msh> netware pname "character string"
```

- Enter the NetWare print server name using up to 47 characters.

NetWare file server names

```
msh> netware fname
```

- Enter the NetWare file server name using up to 47 characters.

Encap type

```
msh> netware encap {802.3|802.2|snap|ethernet2|auto}
```

Remote printer number

```
msh> netware rnum {0-254}
```

Timeout

```
msh> netware timeout {3-255}
```

Printer server mode

```
msh> netware mode pserver
msh> netware mode ps
```

Remote printer mode

```
msh> netware mode rprinter
msh> netware mode rp
```

NDS context name

```
msh> netware context "character string"
```

SAP interval

```
msh> netware "sap_interval"
```

Setting login mode for file server

```
msh> netware login server
```

Setting login mode for NDS tree

```
msh> netware login tree
```

Setting login mode for NDS tree name

```
msh> netware tree "NDS name"
```

File transfer protocol

```
msh> netware trans {ipv4pri|ipxpri|ipv4|ipx}
```

If you do not specify the protocol, the current setting is displayed.

Protocol	Set Protocol
ipv4pri	IPv4+IPX(IPv4)
ipxpri	IPv4+IPX(IPX)
ipv4	IPv4
ipx	IPX

passwd

Use the "passwd" command to change the remote maintenance password.

Changing the password

```
msh> passwd
```

- Enter the current password.
- Enter the new password.

- Re-enter the new password to confirm it.

Changing the password of the administrators using the supervisor

```
msh> passwd {Administrator ID}
```

- Enter the new password.
- Re-enter the new password to confirm it.

2

↓ Note

- Be sure not to forget or lose the password.
- The password can be entered using up to 32 alphanumeric characters. Characters are case-sensitive. For example, "R" is not the same as "r".

pathmtu

Use the "pathmtu" command to display and configure the PathMTU Discovery service function.

View settings

```
msh> pathmtu
```

Configuration

```
msh> pathmtu {on|off}
```

- The default is "on".
- If the MTU size of the sent data is larger than the router's MTU, the router will declare it impassable, and communication will fail. If this happens, setting "pathmtu" to "off" optimizes the MTU size and prevents data output failure.
- Depending on the environment, information might not be obtained from the router, and communication will fail. If this happens, set "pathmtu" to "off".

prnlog

Use the "prnlog" command to obtain printer log information.

Print logs display

```
msh> prnlog
```

- Displays 16 previous print jobs.

```
msh> prnlog "ID Number"
```

- Specify the ID number of the displayed print log information to display additional details about a print job.

↓ Note

- For details about displayed contents, see "Getting Printer Information over the Network".

Reference

- p.79 "Getting Printer Information over the Network"

rhpp

Use the "rhpp" command to view and configure RHPP settings.

View settings

```
msh> rhpp
```

Changing rhpp port number

```
msh> rhpp [1024-65535]
```

- The default is 59100.

Setting timeout

```
msh> rhpp timeout [30-65535]
```

- The default is 300 seconds.

Note

- "RHPP" is an abbreviation of "Reliable Host Printing Protocol", which is a manufacturer-original printing protocol.

route

Use the "route" command to view and control the routing table.

All route information display

```
msh> route get "destination"
```

- Specify the IPv4 address to destination.

"0.0.0.0" cannot be specified as the destination address.

Enabling/disabling specified IPv4 destination

```
msh> route active {host|net} "destination" {on | off}
```

- When the {host | net} parameter is abbreviated, "host" is used by default.

Adding IPv4 routing table

```
msh> route add {host|net} "destination" "gateway"
```

- Adds a host or network route to "destination", and a gateway address to "gateway" in the table.
- Specify the IPv4 address to destination and gateway.
- When the {host|net} parameter is abbreviated, "host" is used by default.

Setting default IPv4 gateway

```
msh> route add default gateway
```

Deleting specified IPv4 destination from routing table

```
msh> route delete {host|net} "destination"
```

- Host becomes the default setting.
- IPv4 address of destination can be specified.

Setting IPv6 default gateway

```
msh> route add6 default gateway
```

Adding a specified IPv6 destination to routing table

```
msh> route add6 "destination" "prefixlen[1-128]" "gateway"
```

- Specify the IPv6 address to destination and gateway.
- If the prefix of the address is between 1 and 127, the network is selected. If the prefix of the address is 128, the host is selected.
- You cannot register a record that has the same destination and prefix as a registered record.
- You cannot register a record that uses "0000:0000:0000:0000:0000:0000:0000:0000" as its destination.

Deleting a specified IPv6 destination from routing table

```
msh> route delete6 "destination" "prefixlen"
```

- Specify the IPv6 address to destination and gateway.

Display information about a specified IPv6 route information

```
msh> route get6 "destination"
```

- Specify the IPv6 address to destination and gateway.

Enabling/disabling a specified IPv6 destination

```
msh> route active6 "destination" "prefixlen" {on | off}
```

Route initialization

```
msh> route flush
```

Note

- The maximum number of IPv4 routing tables is 16.
- The maximum number of IPv6 routing tables is 2.
- Set a gateway address when communicating with devices on an external network.
- The same gateway address is shared by all interfaces.
- "Prefixlen" is a number between 1 and 128.

set

Use the "set" command to set the protocol information display "up" or "down".

View settings

The following command displays the protocol information (up/down).

```
msh> set ipv4
```

```
msh> set ipv6
```

```
msh> set ipsec
```

```
msh> set appletalk
```

```
msh> set netware
```

```
msh> set smb
```

```
msh> set protocol
```

- When protocol is specified, information about IPv4, IPv6, IPsec, AppleTalk, NetWare, and SMB appears.

```
msh> set parallel
```

```
msh> set usb
```

```
msh> set lpr
```

```
msh> set lpr6
```

```
msh> set ftp
```

```
msh> set ftp6
```

```
msh> set rsh
```

```
msh> set rsh6
```

```
msh> set diprint
```

```
msh> set diprint6
```

```
msh> set web
```

```
msh> set snmp
```

```
msh> set ipp
```

```
msh> set ipp6
```

```
msh> set http
```

```
msh> set http6
```

```
msh> set bonjour
```

```
msh> set bonjour6
```

```
msh> set ssl
```

```
msh> set ssl6
```

```
msh> set nrs
msh> set rfu
msh> set rfu6
msh> set nbt
msh> set ssdp
msh> set ssh
msh> set sftp
msh> set sftp6
msh> set wsdev
msh> set wsdev6
msh> set wsprn
msh> set ipds
msh> set rhpp
msh> set rhpp6
msh> set lltd
```

Configuration

- Enter "up" to enable the protocol, and enter "down" to disable the protocol.

You can set the protocol to "active" or "inactive".

```
msh> set ipv4 {up | down}
```

- If you disable IPv4, you cannot use remote access after logging off. If you did this by mistake, you can use the control panel to enable remote access via IPv4.
- Disabling IPv4 also disables lpr, ftp, rsh, diprint, web, snmp, ssl, ipp, http, bonjour, and sftp.

```
msh> set ipv6 {up | down}
```

- If you disable IPv6, you cannot use remote access after logging off. If you did this by mistake, you can use the control panel to enable remote access via IPv6.
- Disabling IPv6 also disables lpr6, ftp6, rsh6, diprint6, ssl6, ipp6, http6, and sftp6.

```
msh> set appletalk {up | down}
```

```
msh> set netware {up | down}
```

```
msh> set smb {up | down}
```

```
msh> set lpr {up | down}
```

```
msh> set lpr6 {up | down}
```

```
msh> set ftp {up | down}
```

```
msh> set ftp6 {up | down}
```

```
msh> set rsh {up | down}
```

```
msh> set rsh6 {up | down}
msh> set diprint {up | down}
msh> set diprint6 {up | down}
msh> set web {up | down}
msh> set snmp {up | down}
msh> set ipp {up | down}
msh> set ipp6 {up | down}
msh> set http {up | down}
msh> set http6 {up | down}
msh> set bonjour {up | down}
msh> set bonjour6 {up | down}
msh> set ssl {up | down}
msh> set ssl6 {up | down}
```

- If Secured Sockets Layer (SSL, an encryption protocol) function is not available for the printer, you cannot use the function by enabling it.

```
msh> set nrs {up | down}
msh> set rfu {up | down}
msh> set rfu6 {up | down}
msh> set ssh {up | down}
msh> set ssdp {up | down}
msh> set nbt {up | down}
msh> set sftp {up | down}
msh> set sftp6 {up | down}
msh> set wsdev {up | down}
msh> set wsdev6 {up | down}
```

- If "wsdev" and "wsdev6" are enabled simultaneously, both appear as "up" on the protocol information display, but both use IPv4 for WS-Device and WS-Printer.

```
msh> set wsprn {up | down}
msh> set ipds {up | down}
msh> set rhpp {up | down}
msh> set rhpp6 {up | down}
msh> set lltd {up | down}
```

show

Use the "show" command to display the network interface board configuration settings.

View settings

```
msh> show
```

- If "-p" is added, you can view settings one by one.

↓ Note

- For details about the information displayed, see "Understanding the Displayed Information".

📖 Reference

- p.85 "Understanding the Displayed Information"

slp

Use the "slp" command to view and configure the SLP settings.

```
msh> slp ttl "ttl_val"
```

- You can search the NetWare server using SLP in the PureIP environment of NetWare 5/5.1 and Netware 6/6.5. Using the "slp" command, you can configure the value of TTL which can be used by SLP multicast packet.
- The default value of TTL is 1. A search is executed only within a local segment. If the router does not support multicast, the settings are not available even if the TTL value is increased.
- The acceptable TTL value is between 1 and 255.
- This command is available only when the NetWare is installed.

smb

Use the "smb" command to configure or delete a computer or workgroup name for SMB.

Computer Name settings

```
msh> smb comp "computer name"
```

- Set computer name using up to 15 characters. Names beginning with "RNP" or "rnp" cannot be entered.

Working Group Name settings

```
msh> smb group "work group name"
```

- Set workgroup name using up to 15 characters.

Comment settings

```
msh> smb comment "comment"
```

- Set comment using up to 31 characters.

Notify print job completion

```
msh> smb notif {on | off}
```

- To notify print job completion, specify "on". Otherwise, specify "off".

Deleting Computer Name

```
msh> smb clear comp
```

Deleting Group Name

```
msh> smb clear group
```

Deleting Comment

```
msh> smb clear comment
```

View Protocol

```
msh> smb protocol
```

snmp

Use the "snmp" command to display and edit the SNMP configuration settings such as the community name.

View settings

```
msh> snmp
```

- Default access settings 1 is as follows:

Community name:public

IPv4 address:0.0.0.0

IPv6 address:::

IPX address:00000000:000000000000

Access type:read-only

Effective Protocol:IPv4/IPv6/IPX

- Default access settings 2 is as follows:

Community name:admin

IPv4 address:0.0.0.0

IPv6 address:::

IPX address:00000000:000000000000

Access type:read-write

Effective Protocol:IPv4/IPv6/IPX

- If "-p" is added, you can view settings one by one.
- To display the current community, specify its registration number.

Display

```
msh> snmp ?
```

Community name configuration

```
msh> snmp "number" name "community_name"
```

- You can configure ten SNMP access settings numbered 1-10.
- The printer cannot be accessed from SmartDeviceMonitor for Admin or SmartDeviceMonitor for Client if "public" is not registered in numbers 1-10. When changing the community name, use SmartDeviceMonitor for Admin and SNMP Setup Tool to correspond with printer settings.
- The community name can be entered using up to 15 characters.

Deleting community name

```
msh> snmp "number" clear name
```

Access type configuration

```
msh> snmp "number" type "access_type"
```

Access type	Type of access permission
no	not accessible
read	read only
write	read and write
trap	user is notified of trapmessages

Protocol configuration

Use the following command to set protocols "active" or "inactive". If you set a protocol "inactive", all access settings for that protocol are disabled.

```
msh> snmp {ipv4|ipv6|ipx} {on|off}
```

- Specify "ipv4" for IPv4, "ipv6" for IPv6, or "ipx" for IPX/SPX.
- {on} means "active" and {off} means "inactive".
- All protocols cannot be turned off concurrently.

Configuration of protocol for each registration number

To change the protocol of access settings, use the following command. However, if you have disabled a protocol with the above command, activating it here has no effect.

```
msh> snmp "number" active {ipv4|ipv6|ipx} {on|off}
```

Access configuration

```
msh> snmp "number" {ipv4|ipv6|ipx} "address"
```

- You can configure a host address according to the protocol used.

- The network interface board accepts requests only from hosts that have IPv4, IPv6, and IPX addresses with access types of "read-only" or "read-write". Enter "0" to have the network interface board accept requests from any host without requiring a specific type of access.
- Enter a host address to deliver "trap" access type information to.
- To specify IPv4 or IPv6, enter "ipv4" or "ipv6" followed by a space, and then the IPv4 or IPv6 address.
- To specify IPX/SPX, enter "ipx" followed by a space, the IPX address followed by a decimal, and then the MAC address of the network interface board.

sysLocation configuration

```
msh> snmp location
```

Deleting sysLocation

```
msh> snmp clear location
```

sysContact setting

```
msh> snmp contact
```

Deleting sysContact

```
msh> snmp clear contact
```

SNMP v1v2 function configuration

```
msh> snmp v1v2 {on|off}
```

- Specify "on" to enable, and "off" to disable.

SNMP v3 function configuration

```
msh> snmp v3 {on|off}
```

- Specify "on" to enable, and "off" to disable.

SNMP TRAP configuration

```
msh> snmp trap {v1|v2|v3} {on|off}
```

- Specify "on" to enable, and "off" to disable.

Remote configuration authorization configuration

```
msh> snmp remote {on|off}
```

- Specify "on" to enable, and "off" to disable the SNMP v1v2 setting.

SNMP v3 TRAP configuration display

```
msh> snmp v3trap
```

```
msh> snmp v3trap {1-5}
```

If a number from 1-5 is entered, settings are displayed for that number only.

Configuring a sending address for SNMP v3 TRAP

```
msh> snmp v3trap {1-5} {ipv4|ipv6|ipx} "address"
```

Configuring a sending protocol for SNMP v3 TRAP

```
msh> snmp v3trap {1-5} active {ipv4|ipv6|ipx} {on|off}
```

Configuring a user account for SNMP v3 TRAP

```
msh> snmp v3trap {1-5} account "account_name"
```

Enter an account name using up to 32 alphanumeric characters.

Deleting an SNMP v3 TRAP user account

```
msh> snmp v3trap {1-5} clear account
```

Configuring an SNMP v3 encryption algorithm

```
msh> snmp v3auth {md5|sha1}
```

Configuring SNMP v3 encryption

```
msh> snmp v3priv {auto|on}
```

Set "auto" for automatic encryption configuration.

Set "on" for mandatory encryption configuration.

sntp

The printer clock can be synchronized with a NTP server clock using Simple Network Time Protocol (SNTP). Use the "sntp" command to change the SNTP settings.

View settings

```
msh> sntp
```

NTP server address configuration

You can specify the IP address of the NTP server.

```
msh> sntp server "IP_address"
```

Interval configuration

```
msh> sntp interval "polling_time"
```

- You can specify the interval at which the printer synchronizes with the operator-specified NTP server. The default is 60 minutes.
- The interval can be entered from 0, or between 15 and 10,080 minutes.
- If you set 0, the printer synchronizes with the NTP server only when you turn the printer on. After that, the printer does not synchronize with the NTP server.

Time-zone configuration

```
msh> sntp timezone "+/-hour_time"
```

- You can specify the time difference between the printer clock and NTP server clock. The values are between -12:00 and +13:00.

spoolsw

Use the "spoolsw" command to view and configure the Job Spool settings.

You can only specify diprint, lpr, ipp, ftp, smb, sftp, and wsprn protocol.

- The "spoolsw" command for configuring Job Spool settings is available only when the hard disk is installed.

View settings

The Job Spool setting appears.

```
msh> spoolsw
```

Job Spool setting

```
msh> spoolsw spool {on | off}
```

- Specify "on" to enable Job Spool, or "off" to disable it.

Resetting Job Spool setting

```
msh> spoolsw clearjob {on | off}
```

- When the printer power is cut during job spooling, this determines whether to reprint the spooled job.

Protocol configuration

```
msh> spoolsw diprint {on | off}
```

```
msh> spoolsw lpr {on | off}
```

```
msh> spoolsw ipp {on | off}
```

```
msh> spoolsw smb {on | off}
```

```
msh> spoolsw ftp {on | off}
```

```
msh> spoolsw sftp {on | off}
```

```
msh> spoolsw wsprn {on | off}
```

ssdp

Use the "ssdp" command to view and configure the SSDP settings.

View settings

```
msh> ssdp
```

Setting effective time

```
msh> ssdp profile {1801-86400}
```

The default is 10800 seconds.

Advertise packet TTL settings

```
msh> sstp ttl {1-255}
```

The default is 4.

ssh

2

Use the "ssh" command to view and configure the SSH settings.

View settings

```
msh> ssh
```

Data compression communication settings

```
msh> ssh compression {on|off}
```

The default is "on".

SSH/SFTP communication port setting

```
msh> ssh port {22, 1024-65535}
```

The default is 22.

SSH/SFTP communication timeout setting

```
msh> ssh timeout {0-65535}
```

The default is 300.

SSH/SFTP communication login timeout setting

```
msh> ssh logintimeout {0-65535}
```

The default is 300.

Setting an open key for SSH/SFTP

```
msh> ssh genkey {512|768|1024} "character string"
```

Create an open key for SSH/SFTP communication.

Usable characters are ASCII 0x20-0x7e (32 bytes) other than "0".

The default key length is 1024, and the character string is blank.

If you do not specify this parameter, an open key with the default value will be created.

Deleting open key for ssh/sftp communication

```
msh> ssh delkey
```

↓ Note

- If you do not specify a character string, current setting is displayed.

status

Use the "status" command to display the printer status.

Messages

```
msh> status
```

↓ Note

- For details, see "Getting Printer Information over the Network".

📖 Reference

- p.79 "Getting Printer Information over the Network"

syslog

Use the "syslog" command to display the information stored in the printer's system log.

View message

```
msh> syslog
```

↓ Note

- For details about the information displayed, see "Message List".

📖 Reference

- p.97 "Message List"

upnp

Use the "upnp" command to display and configure the universal plug and play.

Public URL display

```
msh> upnp url
```

Public URL configuration

```
Msh< upnp url "string"
```

- Enter the URL string in the character string.

web

Use the "web" command to display and configure parameters on Web Image Monitor.

View settings

```
msh> web
```

URL configuration

You can set URLs linked by clicking URL on Web Image Monitor.

Specify "1" or "2" for x as the number corresponding to the URL. Up to two URLs can be registered and specified.

```
msh> web url http://"The URL or IP address you want to register"/
```

Deleting URLs registered as link destinations

```
msh> web x clear url
```

Specify "1" or "2" for x as the corresponding number to the URL.

Link name configuration

You can enter the name for URL that appears on Web Image Monitor.

Specify "1" or "2" for x as the corresponding number to the link name.

```
msh> web name "Name you want to display"
```

Resetting URL names registered as link destinations

```
msh> web x clear name
```

Specify "1" or "2" for x as the number corresponding to the link name.

Help URL configuration

You can set URLs linked by clicking [Help] or [?] on Web Image Monitor.

```
msh> web help http://"Help URL or IP address"/help/
```

Deleting Help URL

```
msh> web clear help
```

wiconfig

Use the "wiconfig" command to make settings for Wireless LAN.

View settings

```
msh> wiconfig
```

View Wireless LAN information

```
msh> wiconfig cardinfo
```

- If Wireless LAN is disabled or unavailable, information about it will not appear.

Configuration

```
msh> wiconfig "parameter"
```

Parameter	Value configured
mode {ap 802.11adhoc}	<p>You can set infrastructure mode (ap), or 802.11 ad hoc mode (802.11adhoc).</p> <p>The default is infrastructure mode.</p>
ssid "ID value"	<p>You can make settings for the SSID in the infrastructure mode.</p> <p>Usable characters are ASCII 0x20-0x7e (32 bytes).</p> <p>An SSID value is set automatically to the nearest access point if no setting is made.</p> <p>If no setting is made for the ad hoc mode, the same value as for the infrastructure mode or an ASSID value is automatically set. The default is blank.</p>
channel "channel no."	<p>You can enable or disable the WEP function. To enable the WEP function, specify [on]; to disable it, specify [off].</p> <p>To start the WEP function, enter the correct WEP key. The default is "11".</p>
key "key value" val {1 2 3 4}	<p>You can specify the WEP key by entering in hexadecimal.</p> <p>With a 64-bit WEP, you can use 10 digit hexadecimals. With a 128-bit WEP, you can use 26 digit hexadecimals.</p> <p>Up to four WEP keys can be registered. Specify the number to be registered with "val".</p> <p>When a WEP is specified by key, the WEP specified by key phrase is overwritten.</p> <p>To use this function, set the same key number and WEP key for all ports that transmit data to each other. Put "0x" on the front of WEP key.</p> <p>You can omit the numbers with "val". The key number is set to 1 when making these omissions. The default is blank.</p>

Parameter	Value configured
keyphrase "phrase" val {1 2 3 4}	<p>You can specify the WEP key by entering in ASCII.</p> <p>With a 64-bit WEP, you can use 10 digit hexadecimals. With a 128-bit WEP, you can use 26 digit hexadecimals.</p> <p>Up to four WEP keys can be registered. Specify the number to be registered with "val".</p> <p>When a WEP is specified by key phrase, the WEP specified by key is overwritten.</p> <p>To use this function, set the same key number and WEP key for all ports that transmit data to each other.</p> <p>You can omit the numbers with "val". The key number is set to 1 when making these omissions.</p>
encval {1 2 3 4}	<p>You can specify which of the four WEP keys is used for packet encoding. "1" is set if a number is not specified.</p>
wepauth [open shared]	<p>You can set an authorization mode when using WEP. The specified value and authorized mode are as follows:</p> <p>open: open system authorization (default)</p> <p>shared: shared key authorization</p>
security {none wep wpa}	<p>You can specify the security mode.</p> <p>none: No encryption (default)</p> <p>wep: WEP encryption</p> <p>wpa: WPA encryption</p>
wpaenc {tkip ccmp}	<p>You can specify WPA encryption key when using WPA encryption.</p> <p>tkip: TKIP (default)</p> <p>ccmp: CCMP (AES)</p>

Parameter	Value configured
wpaauth {wpapsk wpa wpa2psk wpa2 }	<p>You can specify the WPA authentication mode when using WPA encryption.</p> <p>wpapsk: WPA-PSK authentication (default)</p> <p>wpa: WPA (802.1X) authentication</p> <p>wpa2psk: WPA2-PSK authentication</p> <p>wpa2: WPA2 authentication</p>
psk "character string"	<p>You can specify the Pre-Shared key.</p> <p>Usable characters: ASCII 0x20-0x7e (8 to 63 bytes).</p> <p>The default is blank.</p>
eap {tls ttls leap peap} {chap mschap mschapv2 pap md5 tls}	<p>You can specify the EAP authentication type.</p> <p>tls: EAP-TLS (default)</p> <p>ttls: EAP-TTLS</p> <p>leap: LEAP</p> <p>peap: PEAP</p> <p>chap, mschap, mschapv2, pap, md5, and tls are settings for the phase 2 method, and one of these must be specified if EAP-TTLS or PEAP is selected.</p> <p>Do not make these settings when using other EAP authentication types.</p> <p>If you select EAP-TTLS, you can select chap, mschap, mschapv2, pap, or md5.</p> <p>If you select PEAP, you can select mschapv2 or tls.</p>
username "character string"	<p>You can specify the login user name for the Radius server.</p> <p>Usable characters: ASCII 0x20-0x7e (31 bytes) other than "@". The default is blank.</p>
username2 "character string"	<p>You can specify the phase 2 username for EAP-TTLS/PEAP phase 2 authentication.</p> <p>Usable characters: ASCII 0x20-0x7e (31 bytes) other than "@". The default is blank.</p>

Parameter	Value configured
domain "character string"	You can specify the login domain name for the Radius server. Usable characters: ASCII 0x20-0x7e (31 bytes) other than "@". The default is blank.
password "character string"	You can specify the login password for the Radius server. Usable characters: ASCII 0x20-0x7e (128 bytes). The default is blank.
svrcert {on off}	You can set the server certificate. The default is "off".
imca {on off}	You can enable or disable the certificate when the intermediate certificate authority is present. The default is "off".
srvid "character string"	You can set the server ID and sub domain of the certificate server.
connectinfo	Obtains connection information.
clear {a each command all}	Returns the selected setting to its default value. If you specify "all", all settings will be restored to their default values.
miccheck {on off}	You can enable or disable the MIC check function. The default setting is "On" (enabled). If you specify "Off", you cannot perform MIC checks. We recommend you specify "On" for the MIC check function when using this printer.

Note

- You can use this command only when the Wireless LAN interface unit is installed.

wins

Use the "wins" command to configure the WINS server settings.

Viewing settings

```
msh> wins
```

- If the IPv4 address obtained from DHCP differs from the WINS IPv4 address, the DHCP address is the valid address.

Configuration

```
msh> wins "interface_name" {on | off}
```

- {on} means "active" and {off} means "inactive".
- Be sure to specify the interface.
- wlan can be specified only when the Wireless LAN interface unit is installed.

Interface name	Interface configured
ether	Ethernet interface
wlan	Wireless LAN interface

Address configuration

Use the following command to configure the WINS server IP address:

```
msh> wins "interface_name" {primary|secondary} "IP address"
```

- Use the "primary" command to configure the primary WINS server IPv4 address.
- Use the "secondary" command to configure the secondary WINS server IPv4 address.
- Do not use "255.255.255.255" as the IPv4 address.

NBT (NetBIOS over TCP/IP) scope ID selection

You can specify the NBT scope ID.

```
msh> wins "interface_name" scope "ScopeID"
```

- The scope ID can be entered using up to 31 alphanumeric characters.
- Be sure to specify the interface.
- wlan can be specified only when the Wireless LAN interface unit is installed.

Interface name	Interface configured
ether	Ethernet interface
wlan	Wireless LAN interface

wsmfp

Use the "wsmfp" command to view and configure the WSD (Device) and WSD (Printer) settings.

View settings

```
msh> wsmfp
```

Comment settings

```
msh> wsmfp comments "comment"
```

- If you do not specify a comment, current setting is displayed.

Location configuration

```
msh> wsmfp location "location"
```

- If you do not specify a comment, current setting is displayed.

Presentation URL configuration

```
msh> wsmfp url "URL"
```

- Enter the URL string in the "URL".

WSD (Device) TCP port configuration

```
msh> wsmfp devport [1024-65535]
```

- The Default is 53000.

WSD (Printer) TCP port configuration

```
msh> wsmfp prnport [1024-65535]
```

- The Default is 53001.

WSD (Printer) timeout configuration

```
msh> wsmfp prntimeout [30-65535]
```

- The default is 900 seconds.

Comment initialization

```
msh> wsmfp clear comments
```

Location initialization

```
msh> wsmfp clear location
```

Presentation URL initialization

```
msh> wsmfp clear url
```

Getting Printer Information over the Network

This section explains details of each item displayed in the printer status and information.

Current Printer Status

2

The printer status can be checked using the following commands:

- UNIX: Use the "stat" parameter and the "rsh", "rcp", "ftp", and "sftp" commands.
- mshell: Use the "status" command.

★ Important

- Depending on the printer you are using, some of these messages might not appear.

Messages	Description
Adjusting...	The printer is initializing or calibrating.
Call Service Center	There is a malfunction in the printer.
Color Registration Failed	Adjustment of color registration has failed.
Cover Open: Front Cover	The front or top cover is open.
Cover Open: Left Cover	The left cover is open.
Cover Open: Rear Cover	The rear cover is open.
Cover Open: Top Cover	The top cover is open.
Current Job Suspended	Current jobs are suspended.
Empty: Black Toner	The black toner cartridge is almost empty.
Empty: Cyan Toner	The cyan toner cartridge is almost empty.
Empty: Magenta Toner	The magenta toner cartridge is almost empty.
Empty: Yellow Toner	The yellow toner cartridge is almost empty.
Energy Saver Mode	The printer is in Energy Saver Mode.
Error: Ethernet Board	An Ethernet board error has occurred.
Error: HDD Board	A hard disk board error has occurred.
Error: Optional Font	An error has occurred in the font file of the printer.

Messages	Description
Error: Optional RAM	An error has occurred in the SDRAM module.
Error: Parallel I/F Board	An error has occurred in the parallel interface.
Error: PDL	An error has occurred in the page description language.
Error: Rem. Certificate Renewal	An error has occurred in the remote certificate renewal.
Error: USB Interface	An error has occurred in the USB interface.
Error: Wireless Card	Wireless LAN card is not inserted during start up, or the IEEE 802.11 interface unit or the Wireless LAN card is taken out after start up.
Full: Standard Tray	Stacker tray is full.
Full: Waste Toner	The waste toner is full.
Hex Dump Mode	It is a hex dump mode.
Independent-supplier Toner	Toner that is not recommended is set.
Jobs Suspended	All jobs are suspended.
Loading Toner...	Toner is being supplied.
Low: Black Toner	The black toner cartridge is not set correctly, or toner is almost running out.
Low: Cyan Toner	The cyan toner cartridge is not set correctly, or toner is almost running out.
Low: Magenta Toner	The magenta toner cartridge is not set correctly, or toner is almost running out.
Low: Yellow Toner	The yellow toner cartridge is not set correctly, or toner is almost running out.
Malfunction: Tray 1	There is a problem with tray 1.
Malfunction: Tray 2	There is a problem with tray 2.
Malfunction: Tray 3	There is a problem with tray 3.
Malfunction: Tray 4	There is a problem with tray 4.

Messages	Description
Mismatch: Paper Size	The identified paper tray does not contain paper of the selected size.
Mismatch: Paper Size and Type	The identified paper tray does not contain paper of the selected size and type.
Mismatch: Paper Size/Image Size	The identified paper tray does not contain paper that matches the image size.
Mismatch: Paper Type	The identified paper tray does not contain paper of the selected type.
Near Replacing: Black PCU	Prepare a new Black drum unit.
Near Replacing: Color PCU	Prepare a new Color drum unit.
Near Replacing: Fusing Unit	Prepare a new fusing unit.
Near Replacing: Int. Transfer	Prepare a new Transfer Roller.
Near Replacing: Maintenance Kit	Prepare a new Maintenance Kit.
Near Replacing: Print Cartridge	Prepare a new print cartridge.
Nearly Full: Waste Toner	Waste toner bottle is nearly full.
No Paper: Selected Tray	There is no paper in the specified tray.
No Paper: Tray 1	There is no paper in tray 1.
No Paper: Tray 2	There is no paper in tray 2.
No Paper: Tray 3	There is no paper in tray 3.
No Paper: Tray 4	There is no paper in tray 4.
No Paper: Tray 5	There is no paper in tray 5.
Not Detected: Black Toner	Black toner is not correctly set.
Not Detected: Cyan Toner	Cyan toner is not correctly set.
Not Detected: Fusing Unit	The fusing unit is not correctly set.
Not Detected: Input Tray	The paper feed tray is not correctly set.
Not Detected: Magenta Toner	Magenta toner is not correctly set.

Messages	Description
Not Detected: PCU (C)	The drum unit (cyan) is not correctly set.
Not Detected: PCU (K)	The drum unit (black) is not correctly set.
Not Detected: PCU (M)	The drum unit (magenta) is not correctly set.
Not Detected: PCU (Y)	The drum unit (yellow) is not correctly set.
Not Detected: Print Cartridge	The paper print cartridge is not correctly set.
Not Detected: Tray 1	Tray 1 is not correctly set.
Not Detected: Tray 2	Tray 2 is not correctly set.
Not Detected: Tray 3	Tray 3 is not correctly set.
Not Detected: Tray 4	Tray 4 is not correctly set.
Not Detected: Tray 5	Tray 5 is not correctly set.
Not Detected: Yellow Toner	Yellow toner is not correctly set.
Not Detected: Int. Transfer Unit	The transfer unit is not correctly set.
Not Detected: WasteToner Bottle	Waste toner bottle is not correctly set.
Offline	The printer is offline.
Panel Off Mode	The printer is in Panel-Off mode.
Paper in Duplex Unit	The paper remains in the duplex unit.
Paper Misfeed: Duplex Unit	The paper has jammed in the duplex unit.
Paper Misfeed: Input Tray	The paper has jammed in the input tray.
Paper Misfeed: Internal/Output	The paper has jammed inside the printer.
Paper Misfeed: Optional Tray 1	The paper has jammed in the optional tray 1.
Paper Misfeed: Optional Tray 2	The paper has jammed in the optional tray 2.
Paper Misfeed: Optional Tray 3	The paper has jammed in the optional tray 3.
Paper Misfeed: Optional Tray 4	The paper has jammed in the optional tray 4.
Printing...	Printing is in progress.
Proxy User/Password Incorrect	Proxy user name or Password is incorrect.

Messages	Description
RC Gate Connection Error	Connection with the RC Gate failed.
Ready	The printer is ready to print.
Replace Black PCU	It is time to replace the black drum unit.
Replace Fusing Unit	It is time to replace the fusing unit.
Replace Int. Transfer Unit	It is time to replace the transfer unit.
Replace Maintenance Kit	It is time to replace the maintenance kit.
Replace PCU (Color)	It is time to replace the color drum unit.
Replace Print Cartridge	It is time to replace the print cartridge.
Reset IPDS fonts	The IPDS fonts are being reset.
SD Card Authentication failed	SD card authentication failed.
Supplies Order Call failed	The supply order call has failed.
Tray Error: Duplex Printing	Selected paper tray cannot be used for duplex printing.
Warming Up...	The printer is warming up.
W.T.Bttl.notDetected/L.Cvr.Open	The left cover is open, or the waste toner bottle is not set.

↓ Note

- Check the error contents that may be printed in the configuration page. For details about printing a configuration page, see "List/Test Print Menu", Software Guide.

Printer Configuration

You can check the printer configuration using telnet.

This section explains the checking procedure for input/output tray and printer language.

- UNIX: Use the "info" parameter and the "rsh", "rcp", "ftp", and "sftp" commands.
- mshell: Use the "info" command.

Input Tray

Item	Description
No.	ID number of the paper tray

Item	Description
Name	Name of the paper tray
PaperSize	Size of paper loaded in the paper tray
status	Current status of the paper tray <ul style="list-style-type: none"> • Normal: Normal • NoInputTray: No tray • PaperEnd: No paper

Output Tray

Item	Description
No.	ID number of the output tray
Name	Name of the output tray
status	Current status of the output tray <ul style="list-style-type: none"> • Normal: Normal • PaperExist: Paper exist • OverFlow: Paper is full • Error: Other errors

Printer Language

Item	Description
No.	ID number of the printer language used by the printer
Name	Name of the printer language used in the printer
Version	Version of the printer language

↓ Note

- For details about mshell "info" commands, see "Using telnet".

📖 Reference

- p.39 "Using telnet"

Understanding the Displayed Information

This section explains how to read status information returned by the network interface board.

Print Job Information

2

Use the following command to display print job information:

- UNIX: Use the "info" parameter and the "rsh", "rcp", "ftp", and "sftp" commands.
- mshell: Use the "info" command.

Item	Description
Rank	Print job status <ul style="list-style-type: none"> • Active Printing or preparing for printing <ul style="list-style-type: none"> • 1st, 2nd, 3rd, 4th... Waiting to be transferred to the printer
Owner	Print request user name
Job	Print request number
Files	The name of the document
Total Size	The size of the data (spooled) The default is 0 bytes

Note

- For details about mshell "info" commands, see "Using telnet".

Reference

- p.39 "Using telnet"

Print Log Information

This is a record of the most recent 16 jobs printed.

Use the following command to display print log information:

- UNIX: Use the "prnlog" parameter and the "rsh", "rcp", "ftp", and "sftp" commands.
- mshell: Use the "prnlog" command. See "Using telnet".

Item	Description
ID	Print request ID.
User	Print request user name.
Page	Number of pages printed
Result	<p>Print Request Result</p> <p>Communication Result</p> <ul style="list-style-type: none"> • OK Print was completed normally. However, the print result may not be as required due to printer problems. • NG Printing was not completed normally. • Canceled An "rcp", "rsh", or "lpr" command print request was canceled, possibly due to the printing application. Not applicable to the "ftp" or "rprinter" command.
Time	<p>Time the print requested was received.</p> <p>Time of print request reception</p>
User ID	<p>Printer driver-configured User ID.</p> <p>Appears when the print request ID is specified.</p>
JobName	<p>Name of the document for printing</p> <p>Appears when the print request ID is specified.</p>

Note

- For details about mshell "info" commands, see "Using telnet".

Reference

- p.39 "Using telnet"

Configuring the Network Interface Board

Use the following command to display network interface board settings:

- mshell: Use the "show" command.

Item		Description
Common		
	Mode	
	Protocol Up/Down	Protocol Settings
	AppleTalk	
	IPv4	
	IPv6	
	IPsec	
	NetWare	
	SMB	
	Device Up/Down	Device Settings
	Parallel	
	USB	
	Ethernet interface	
	Syslog priority	
	NVRAM version	
	Device name	
	Comment	
	Location	
	Contact	
	Soft switch	
	AppleTalk	AppleTalk settings
	Mode	
	Net	
	Object	

Item		Description
	Type	
	Zone	
TCP/IP		TCP/IP settings
	Mode(IPv4)	
	Mode(IPv6)	
	ftp	
	lpr	
	rsh	
	diprint	
	web	
	http	
	ftpc	
	snmp	
	ipp	
	autonet	
	Bonjour	
	ssl	
	nrs	
	rfu	
	nbt	
	ssdp	
	ssh	
	sftp	
	WSD (Device)	
	WSD (Printer)	

Item		Description
	ipds	
	rhpp	
IPv4		
	DHCP	
	Address	
	Netmask	
	Broadcast	
	Gateway	
IPv6		
	Stateless	
	Manual	
	Gateway	
	DHCPv6-lite	
	DUID	
	DHCPv6 option lifetime	
IPsec		
	Manual Mode	
	Excluded Protocol	
	https	
	dns	
	dhcp	
	wins	
EncapType		
Host name		
DNS Domain		

Item		Description
	Access Control	Access Control settings
	IPv4	
	Access Entry[X]	X can be set between 1 and 5.
	IPv6	
	Access Entry[X]	X can be set between 1 and 5.
	SNTP Server	Time settings
	Time Zone	
	SNTP Server polling time	
	SYSLOG server	Websys settings
	Home page URL1	
	Home page link name 1	
	Home page URL2	
	Home page link name2	
	Help page URL	
	IPDS Port	
	IPDS timeout	
	RHPP Port	
	RHPP timeout	
	NetWare	
	EncapType	
	RPRINTER number	
	Print server name	
	File server name	
	Context name	
	Switch	

Item		Description
	Mode	
	NDS/Bindery	
	Packet negotiation	
	Login Mode	
Print job timeout		
Protocol		
SAP interval time		
NDS Tree Name		
Transfer Protocol		
SMB		SMB settings
Switch		
	Mode	
	Direct print	
	Notification	
Workgroup name		
Computer name		
Comment		
Share name[1]		
Protocol		
Wireless LAN		Wireless LAN settings
Host name		
Communication Mode		
SSID		
Channel		
Security		

Item		Description
	WEP Authentication	
	WEP Encryption key number	
	WEP Encryption keys[X]	X can be set between 1 and 4.
	WPA Encryption	
	WPA Authentication	
	Pre-Shared Key	
	User name	
	Domain name	
	EAP Type	
	Password	
	Phase 2 user name	
	Phase 2 Method TTLS	
	Phase 2 Method PEAP	
	Server cert.	
	Intermediate CA	
	Server ID	
	Sub domain	
	Mic check	
Ethernet		
	802.1X Authentication	
DNS		DNS settings
	IPv4	
	Server[X]	X can be set between 1 and 3.
	Selected IPv4 DNS Server	
	IPv6	

Item		Description
	Server[X]	X can be set between 1 and 3.
	Selected IPv6 DNS Server	
	Resolver Protocol	
Domain name		
	ether	
	wlan	
DDNS		
	ether	
	wlan	
WINS		WINS settings
	ether	
	Primary WINS	
	Secondary WINS	
	wlan	
	Primary WINS	
	Secondary WINS	
SSDP		SSDP settings
	UUID	
	Profile	
	TTL	
UPnP		UPnP settings
	URL	
Bonjour		Bonjour (Rendezvous) settings
	Computer Name (cname)	
	Local Hostname (ether)	

Item		Description
	Local Hostname (wlan)	
	Location	
	Priority (diprint)	
	Priority (lpr)	
	Priority (ipp)	
	IP TTL	
	LinkLocal Route for Multi I/F	
	IPP Port	
SNMP		SNMP settings
	SNMPv1v2	
	SNMPv3	
	Protocol	
	v1Trap	
	v2Trap	
	v3Trap	
	SNMPv1v2 Remote Setting	
	SNMPv3 Privacy	
ssh		ssh settings
	Compression	
	Port	
	TimeOut	
	LoginTimeOut	
AuthFree		Authfree settings
	IPv4	
	AuthFreeEntry[X]	X can be set between 1 and 5.

Item		Description
	IPv6	
	AuthFreeEntry[X]	X can be set between 1 and 5
	Parallel	
	USB	
LPR		
	lprm check host	
	lpr prnerrchk	
Certificate		
	Verification	
WS-MFP		
	Network Device Name	
	Comments	
	Location	
	Presentation URL	
	WSD (Device) TCP Port	
	WSD (Printer) TCP Port	
	WSD (Printer) Job Timeout	
	MetadataVersion	
	UUID	
IEEE 802.1X		IEEE 802.1X settings
	User name	
	Domain name	
	EAP Type	
	Password	
	Phase 2 user name	

Item		Description
	Phase 2 Method TTLS	
	Phase 2 Method PEAP	
	Server cert	
	Intermediate CA	
	Server ID	
	Sub domain	
Shell mode		Remote maintenance tool mode

Message List

This is a list of messages that appear in the printer's system log. The system log can be viewed using the "syslog" command.

System Log Information

2

Use the following command to display the system log information:

- UNIX: Use the "syslog" parameter and the "rsh", "rcp", "ftp", and "sftp" commands.
- mshell: Use the "syslog" command.

★ Important

- Depending on the printer you are using, some of these messages might not appear.

Access to NetWare server <file server name> denied. Either there is no account for this print server on the NetWare server or the password was incorrect.

Login to the file server failed when the print server was online. Make sure the print server is registered in <file server name>. If a password is specified for the print server, delete the password.

account is unavailable: same account name be used.

User account is disabled. This could be because it uses the same account name as the administrator account.

account is unavailable: The authentication password is not set up.

User account is disabled. This could be because the authentication password is not set, and only the encryption account is set.

account is unavailable: encryption is impossible.

Encryption is not possible and account is disabled. This could be because:

- Security option is not installed.
- Encryption password has not been specified.

add_sess_IPv4:bad trap addr :<IPv4 address>, community:<community name>

The IPv4 address (0.0.0.0.) is unavailable when the community access type is TRAP. Specify the host IPv4 address for the TRAP destination.

add_sess_IPv6:bad trap addr :<IPv6 address>, community:<community name>

The IPv6 address [::] is unavailable when the community access type is TRAP. Specify the host IPv6 address for the TRAP destination.

add_sess_IPv4: community <community name> already defined.

The same community name already exists. Use another community name.

add_sess_IPv6: community <community name> already defined.

The same community name already exists. Use another community name.

add_sess_IPX: bad trap addr :<IPX address>, community:<community name>

The IPX address (00:00:00:00:00:00) is unavailable when the community access type is TRAP. Specify the host IPX address for the TRAP destination.

add_sess_IPX: community <community name> already defined.

The same community name already exists. Use another community name.

adjust time server <NTP server> offset:xx sec.

ncsd tells you the timing of the NTP server and whether or not the time system clock is set.

- NTP Server: NTP server name
- offset: number of seconds of delay (minus number if a time in advance is specified)

Attach FileServer =<file server>

Connection to the file server as the nearest server has been established.

Attach to print queue <print queue name>

The system connects to the print queue when the print server goes online.

authenticating

The supplicant is authenticating with the access point (EAP or WPA).

authentication mode mismatch

The authentication mode of the access point is different from the authentication mode of the supplicant. Use the same authentication mode between the access point and the supplicant.

authenticated

The supplicant has been authenticated.

The authentication was successful. If authentication is successful, this message always appears at the end of the process.

centrod is disabled.

Parallel communication could not be established. Enable "centrod" in the security mode setting.

child process exec error! (process name)

The network service failed to start. Turn the printer off and then on. If this does not work, contact your service or sales representative.

cipher suite mismatch

The uni-cast / multi-cast suite (TKIP/AES/WEP) of the access point is different from the suite used by the supplicant.

client EAP method rejected

The authentication mode of the access point is different with the authentication mode of the supplicant. Use the same authentication mode between the access point and the supplicant.

client password rejected

The client's password was rejected. Check the client password.

client TLS certificate rejected

The client's TLS certificate was rejected. Check the certificate.

Connected DHCP Server (<DHCP server address>)

The IP address was successfully received from the DHCP server.

connecting

The supplicant is establishing the Wireless LAN connection with the access point.

Connected DHCPv6 server <IPv6 address>

The IP address was successfully received from the DHCPv6 server.

Could not attach to FileServer <error number>

Connection to the file server could not be established when the remote printer went online. The file server refused the connection for unknown reason. Check the file server's configuration.

Could not attach to PServer <print server name>

Connection to the print server has not been established when the remote printer is turned on. The print server has refused the connection. Check the print server configuration.

connection from <IP address>

A user logged in from the host <IP address>.

Current Interface Speed : <Ethernet I/F speed>

Speed of the network (10Mbps, 100 Mbps, or 1 Gbps).

Current IP address (<current IP address>).

The <current IP address> was acquired from DHCP server.

Current IPX address <IPX address>

The current IP address is <IPX address>.

DHCP lease time expired.

DHCP lease time has expired. Carry out the DHCP Discover. The IP address you have used is no longer available.

DHCP server not found.

The DHCP server was not found. Make sure that the DHCP is on the network.

DHCPv6 server not found.

The DHCPv6 server was not found. Make sure that the DHCPv6 is on the network.

disconnected

The supplicant has no connection.

dpsd is disabled.

Communication via PictBridge is unavailable because PictBridge is disabled in the security mode. Enable PictBridge in the security mode.

Duplicate IP=<IP address>(from <MAC address>).

A conflicting IPv4 or IPv6 address was used. Each IPv4 or IPv6 address must be unique. Check the device address in [MAC address].

Established SPX Connection with PServer, (RPSocket=<socket number>, connID=<connection ID>)

Connection to the print server was established when the remote printer went online.

exiting

The LPD service was completed and the process is exiting.

Exit pserver

(In the print server mode) The print server function is disabled because the necessary print server settings have not been made.

Frametype =<frametype name>

The specified frame type name <frame type name> is for NetWare use.

httpd start.

The httpd has started.

IEEE 802.11 Card does NOT support WPA.

A Wireless LAN card that does not support WPA is installed. Install a Wireless LAN card that supports WPA.

IEEE 802.11 Card Firmware REV.<version>

Displays the version number of the 802.11 card's firmware.

IEEE 802.11 current channel <channel number>

Displays the current channel number of the active Wireless LAN card (in ad hoc and infrastructure mode).

IEEE 802.11 MAC Address = <MAC address>

Displays the MAC address of the Wireless LAN interface.

IEEE 802.11 SSID <ssid> (AP MAC Address <MAC address>)

The MAC address and SSID of the access point are connected in infrastructure mode.

IEEE 802.11 <communication mode> mode

Displays the IEEE 802.11 communication mode.

**(IKE phase-1) mismatched authentication type : local=<authentication type 1>
remote=<authentication type 2>**

This printer's <authentication type 1> in IKE phase 1 does not match the communicating host's <authentication type 2>. Make sure this printer's ISAKMP SA authentication type matches that of the communicating host.

**(IKE phase-1) mismatched encryption type : local=<encryption algorithm 1>
remote=<encryption algorithm 2>**

This printer's ISAKMP SA Oakley group <encryption algorithm 1> in IKE phase 1 does not match the communicating host's ISAKMP SA Oakley group < encryption algorithm 2>. Make sure this printer's ISAKMP SA Oakley group matches that of the communicating host.

(IKE phase-1) mismatched DH group: local=<DH group number 1> remote=<DH group number 2>

This printer's ISAKMP SA Oakley group <DH group number 1> in IKE phase 1 does not match the communicating host's ISAKMP SA Oakley group <DH group number 2>. Make sure this printer's ISAKMP SA Oakley group matches that of the communicating host.

(IKE phase-1) mismatched hash type: local=<Hash Algorithm 1> remote=<Hash Algorithm 2>

This printer's ISAKMP SA <Hash Algorithm 1> in IKE phase 1 does not match the communicating host's ISAKMP SA <Hash Algorithm 2>. Make sure this printer's ISAKMP SA Hash Algorithm matches that of the communicating host.

IKE[%s] is disable, set PSK text.

The specified IKE entry is invalid. Enter the PSK text.

inetd start.

The inetd service has started.

Interface(interface name):Duplicate IP Address (<IP address>).

The same IP (IPv4 or IPv6) address was used. Each IP address must be unique. Check the address of the device indicated in [IP address].

<interface name> card removed

The interface managed by the supplicant has been removed.

<interface name> interface down

The interface managed by the supplicant is disabled, or cannot connect to the access point.

<interface name> interface up

The interface managed by the supplicant is enabled, or is connected to the access point.

<Interface> started with IP : <IP address>

IP address (IPv4 or IPv6 address) has been set for the interface and is operating.

<Interface>: Subnet overlap.

The same IP address (IPv4, or IPv6 address) and the subnet mask is used with other device.

IPP cancel-job: permission denied.

User name authentication failed when the spooled job was being canceled.

IPP job canceled. jobid=%d.

The spooled job was canceled due to error or user request.

job canceled. jobid=<job ID>.

The spooled job was canceled due to error or user request.

LeaseTime=<lease time>(sec), RenewTime=<renew time>(sec).

The resource lease time received from the DHCP server is displayed in [lease time] in seconds. The renewal time is displayed in [renew time] in seconds.

LEAP challenge to access point failed

The LEAP challenge to the access point has failed.

Login to fileserver <file server name> (<IPX | IP>,<NDS | BINDERY>)

When the print server was online, the system logged in to <file server> in NDS or BINDERY mode. The transfer protocol in use is also displayed.

Manual[%s] is disable, set authentication key.

The specified manual SA entry is invalid. Set the authentication key.

Manual[%s] is disable, set encryption key.

The specified manual SA entry is invalid. Set the authentication key.

Memory allocate error.

Data cannot be obtained.

Disconnect the USB cable, and then connect it.

MIC failure TKIP counter measures started

The supplicant using TKIP has detected two instances of tampering within 60 seconds and has started counter measures.

MIC failure TKIP counter measures stopped

Counter measures have stopped after 60 seconds (since the supplicant using TKIP started counter measures against tampering).

Name registration failed. name=<NetBIOS name>

Name registration of <NetBIOS Name> failed. Change to a different NetBIOS name.

Name registration success in Broadcast name=<NetBIOS name>

Name registration by <NetBIOS Name> broadcast was successful.

Name registration success. WINS Server =<WINS server address> NetBIOS Name=<NetBIOS name>

Name registration of <NetBIOS Name> to <WINS server address> was successful.

nbttd start.

The nbttd (NetBIOS over TCP/IP Daemon) has started.

no RADIUS/authentication server

The supplicant has received a message reporting that a usable RADIUS server cannot be found.

no smart card detected on device

PEAP/GTC (Generic Token Card) is selected, but a smart card using GTC authentication cannot be found.

no SSID in scan result

A network with the SSID you specified was not found.

The specified SSID might not be available, or the signal from the access point/multi-channel might be weak.

no WPA information element in probe response, rescanning

There is no WPA information on the response from the SSID probe of the access point you want to use.

The supplicant is rescanning.

npriter start. (NetWare)

(In the remote printer mode) The NetWare service has started.

nwstart start. (NetWare)

The NetWare protocol stack setup server has started.

Open log file <file name>

The specified log file was opened when the print server was online.

papd start. (AppleTalk)

The papd (Printer Access Protocol Daemon) has started.

permission denied.

The permission was denied after checking the user name and host address at the job cancel (except for the root permission).

pserver start. (NetWare)

NetWare service has started in print server mode at the print server operation.

Printer <printer name> has no queue

The print queue is not assigned to the printer when the print server was online. Assign the print queue to the printer using NetWare administrator account, and then restart the printer.

Print queue <print queue name> cannot be serviced by printer 0, <print server name>

The print queue cannot be established when the print server is online. Make sure that the print queue exists on the specified file server.

Print server <print server name> has no printer

The printer was not assigned to the print server when the print server was online. Use the NetWare administrator account to assign the printer, and then restart the printer.

print sessions full

No more print jobs can be accepted. Wait a while before sending any more print jobs.

Required file server(<file server name>) not found

The required file server <file server name> could not be found.

restarted.

The LPD has started.

sap enable, saptype=<SAP type>, sapname=<SAP name>

The SAP function was started. The SAP packet is issued to advertise the service in the SAP table on the NetWare server.

server certificate invalid

The server ID is disabled. Check the server authentication.

server identity invalid

The server ID is disabled. Check the server name authentication.

server not trusted

The RADIUS server cannot be trusted.

Session_IPv4 <community name> not defined.

The requested community name is not defined.

Session_IPv6 <community name> not defined.

The requested community name is not defined.

session_IPX <community name> not defined.

The requested community name is not defined.

Set context to <NDS context name>

The NDS context name <NDS context name> has been set.

shutdown signal received. network service rebooting...

The network reboot process is starting.

smbd start. (NetBIOS)

SMBD (Server Message Block Daemon) has been started.

Snmpd Start.

The snmpd has started. This message is displayed only when the power is turned ON.

SMTPC: failed to get smtp server ip-address.

The SMTP server IP address could not be obtained. This could be because:

- The specified DNS server could not be found.
- No connection to the network has been established.
- The specified DNS server could not be found.
- An incorrect DNS server is specified.
- The specified SMTP server IP address could not be found in the DNS server.

SMTPC: failed to connect smtp server. timeout.

Connection to the SMTP server failed due to timeout. This could be because the specified SMTP server name is incorrect, or no connection to the network has been established, or the network configuration is incorrect, so there is no response from the SMTP server. Check the SMTP server name, or the network connection and configuration.

SMTPC: refused connect by smtp server.

Connection to the SMTP server is denied. This could be because server other than the SMTP server has been specified, or the specified SMTP server port number is incorrect. Check the SMTP server name, port number, or the SMTP server port number.

SMTPC: no smtp server. connection close.

Connection to the SMTP server failed due to no response from SMTP. This could be because a server other than the SMTP server has been specified, or the specified SMTP server port number is incorrect. Check the SMTP server name, port number, or the SMTP server port number.

SMTPC: failed to connect smtp server.

Connection to the SMTP server failed. This could be because no connection to the network has been established, or the network configuration is incorrect, so there is no response from the SMTP server, or the specified SMTP server name is incorrect, or the specified SMTP server IP address could not be found in the DNS server, or a server other than the SMTP server has been specified, or the specified SMTP server port number is incorrect. Check the DNS Server's IP address and SMTP server's IP address, or the SMTP server name and SMTP port number, or the SMTP server's SMTP port number, or the network connection and configuration.

SMTPC: username or password wasn't correct. [response code] (information)

Connection to the SMTP server failed, because the specified SMTP user name is incorrect, or the specified SMTP password is incorrect. Check the SMTP user name and password.

Snmp over IPv4 is ready.

Communication over IPv4 with snmp is available.

Snmp over IPv6 is ready.

Communication over IPv6 with snmp is available.

Snmp over IPX is ready.

Communication over IPX with snmp is available.

started.

The direct printing service has started.

started.

The IKE service has started.

Started.

The bonjour (rendezvous) function has started.

stopped

The supplicant has just stopped.

success key received

The supplicant received the EAP-Success key.

success but invalid key

The supplicant received a message reporting that EAP authentication was successful, but the EAPOL key was invalid.

supplicant unbound

The supplicant is not connected to the unbound access point.

supplicant started

The supplicant has just started.

terminated.

IKE service has stopped because any configurations for the manual SA and IKE does not exist.

Terminated.

The bonjour (rendezvous) function is disabled.

There is problem in dhcp server operation.

There is a problem with the DHCP server.

If multiple DHCP servers are active on the network, check that they are assigning unique IP addresses to each printer.

The print server received error <error number> during attempt to log in to the network. Access to the network was denied. Verify that the print server name and password are correct.

Login to the file server failed when the print server was online. The print server is not registered or a password is specified. Register the print server without specifying a password.

too many pictures.

PictBridge printing failed because too many images are sent during one print transaction. Reduce the number of images at one print transaction.

trap account is unavailable.

v3Trap cannot be sent. This could be because the Trap destination account is different from the account specified by the printer.

unauthenticated

The authentication failed. The supplicant was denied access to the access point, or was not authenticated.

Updated (option name) (value) via DHCPv6 Server

The parameter obtained from the DHCP server has been updated.

usbd is disabled.

Plug and Play is unavailable because the printer is in security mode. Enable USB D in Security Mode.

waiting for keys

The supplicant is waiting for the session key.

WINS name registration: No response to server (WINS server address)

There was no response from the WINS server. Check that the correct WINS server address is entered. Also, check that the WINS server is functioning properly.

WINS wrong scopeID=<scope ID>

The scope ID is invalid. Use a valid scope ID.

write error occurred.(diskfull)

A "diskfull" error occurred while the printer was writing to the spool file. Wait for the current print job to finish. When it finishes, more HDD space will be available. Only pages that were spooled when the error occurred will be printed.

write error occurred.(fatal)

A "diskfull" error occurred while the printer was writing to the spool file. Wait for the current print job to finish. When it finishes, more HDD space will be available. Only pages that were spooled when the error occurred will be printed.

WSD (Device) started.

WSD (Device) has started.

WSD (Printer) started.

WSD (Printer) has started.

INDEX

8021x.....40

A

access.....41
authfree.....42
autonet.....43

B

Before setup.....5
Billing code.....35
Binding.....31
bonjour.....44
BSD UNIX workstation.....16, 19

C

Collating.....30
Configuring the device option.....21
Copies.....30
Copying information.....20

D

Deleting the printer.....10
Device option.....21
devicename.....45
dhcp.....46
dhcpó.....47
diprint.....47
dns.....48
domainname.....50
Duplex printing.....31

E

etherauth.....51
etherconfig.....51

F

ftp.....17, 19, 97
ftp commands.....5

G

Gradation quality.....34

H

help.....51

hostname.....51
How to read this manual.....4
HP-UJ.....14, 16, 19

I

ifconfig.....52
Image direction.....33
info.....53
Input tray.....25
Installation shell script.....7, 8, 11
IP address.....7
ipds.....54
ipp.....54
ipsec.....54
ipv6.....55

J

Job spool.....69

L

Linux.....16, 19
logout.....55
lp.....16
lp commands.....5
lpq.....19
lpr.....16, 56
LPR.....56
lpr commands.....5
lpstat.....19

M

Message.....97

N

netware.....56
Network interface board.....86

O

Orientation.....32
Output tray.....29

P

Paper size.....26
Paper type.....27
passwd.....57

pathmtu.....	58
Print job.....	85
Print job status.....	19
Print log.....	85
Printer configuration.....	83
Printer information.....	79
Printer language.....	24
Printer status.....	19, 79
Printing method.....	16
prnlog.....	58

R

rcp.....	17, 97
rcp commands.....	5
Resolution.....	33
rhpp.....	59
route.....	59
rsh.....	17, 19, 97
rsh commands.....	5

S

set.....	61
sftp.....	97
show.....	64
slp.....	64
smb.....	64
snmp.....	65
sntp.....	68
Solaris.....	13, 16, 19
spoolsw.....	69
ssdp.....	69
ssh.....	70
status.....	71
Symbol set.....	36
syslog.....	71, 97
System log.....	71
System log information.....	97
System V UNIX.....	19

T

telnet.....	39
Text printing.....	25

U

upnp.....	71
Usercode.....	35

W

web.....	71
wiconfig.....	72
Windows setup.....	5
wins.....	76
Wireless LAN.....	72
wsmftp.....	77

MEMO

MEMO

Trademarks

AppleTalk[®] and Bonjour[®] are trademarks of Apple Inc., registered in the U.S. and other countries.

IPS is a trademark or registered trademark of Zoran Corporation and/or its subsidiaries in the United States or other countries.

Linux[®] is the registered trademark of Linus Torvalds in the U.S. and other countries.

Microsoft[®], Windows[®], Windows Server[®], and Windows Vista[®] are either registered trademarks or trademarks of Microsoft Corporation in the United States and/or other countries.

Monotype is a registered trademark of Monotype Imaging, Inc.

NetWare, IPX, IPX/SPX are either registered trademarks or trademarks of Novell, Inc.

PCL[®] and HP-UX are registered trademarks of Hewlett-Packard Company.

PictBridge is a trademark.

PostScript is a registered of Adobe Systems Incorporated.

RED HAT is a registered trademark of Red Hat, Inc.

Sun, SunOS and Solaris are trademarks or registered trademarks of Sun Microsystems, Inc. in the U.S. and other countries.

UNIX[®] is a registered trademark of The Open Group.

UPnP[™] is a trademark of the UPnP Implementers Corporation.

Other product names used herein are for identification purposes only and might be trademarks of their respective companies. We disclaim any and all rights to those marks.

The proper names of the Windows operating systems are as follows:

- * The product names of Windows 2000 are as follows:
 - Microsoft[®] Windows[®] 2000 Professional
 - Microsoft[®] Windows[®] 2000 Server
 - Microsoft[®] Windows[®] 2000 Advanced Server
 - Microsoft[®] Windows[®] 2000 Datacenter Server
- * The product names of Windows XP are as follows:
 - Microsoft[®] Windows[®] XP Professional
 - Microsoft[®] Windows[®] XP Home Edition
 - Microsoft[®] Windows[®] XP Media Center Edition
 - Microsoft[®] Windows[®] XP Tablet PC Edition
 - Microsoft[®] Windows[®] XP Professional x64 Edition
- * The product names of Windows Vista are as follows:
 - Microsoft[®] Windows Vista[®] Ultimate
 - Microsoft[®] Windows Vista[®] Business
 - Microsoft[®] Windows Vista[®] Home Premium
 - Microsoft[®] Windows Vista[®] Home Basic
 - Microsoft[®] Windows Vista[®] Enterprise
- * The product names of Windows 7 are as follows:
 - Microsoft[®] Windows[®] 7 Starter
 - Microsoft[®] Windows[®] 7 Home Premium
 - Microsoft[®] Windows[®] 7 Professional
 - Microsoft[®] Windows[®] 7 Ultimate
- * The product names of Windows Server 2003 are as follows:
 - Microsoft[®] Windows Server[®] 2003 Standard Edition
 - Microsoft[®] Windows Server[®] 2003 Enterprise Edition
 - Microsoft[®] Windows Server[®] 2003 Web Edition
 - Microsoft[®] Windows Server[®] 2003 Datacenter Edition
- * The product names of Windows Server 2003 R2 are as follows:
 - Microsoft[®] Windows Server[®] 2003 R2 Standard Edition
 - Microsoft[®] Windows Server[®] 2003 R2 Enterprise Edition
 - Microsoft[®] Windows Server[®] 2003 R2 Datacenter Edition
- * The product names of Windows Server 2008 are as follows:
 - Microsoft[®] Windows Server[®] 2008 Foundation
 - Microsoft[®] Windows Server[®] 2008 Standard
 - Microsoft[®] Windows Server[®] 2008 Enterprise
 - Microsoft[®] Windows Server[®] 2008 Datacenter
 - Microsoft[®] Windows Server[®] 2008 for Itanium-based Systems
 - Microsoft[®] Windows[®] Web Server 2008
 - Microsoft[®] Windows[®] HPC Server 2008
 - Microsoft[®] Windows Server[®] 2008 Standard without Hyper-V[™]
 - Microsoft[®] Windows Server[®] 2008 Enterprise without Hyper-V[™]
 - Microsoft[®] Windows Server[®] 2008 Datacenter without Hyper-V[™]
- * The product names of Windows Server 2008 R2 are as follows:
 - Microsoft[®] Windows Server[®] 2008 R2 Foundation
 - Microsoft[®] Windows Server[®] 2008 R2 Standard
 - Microsoft[®] Windows Server[®] 2008 R2 Enterprise
 - Microsoft[®] Windows Server[®] 2008 R2 Datacenter
 - Microsoft[®] Windows Server[®] 2008 R2 for Itanium-based Systems
 - Microsoft[®] Windows[®] Web Server R2 2008
 - Microsoft[®] Windows[®] HPC Server R2 2008



Notes for Users

These notes explain additional information for Hardware Guide. Read the following in conjunction with the manual.

Hardware Guide » **Installing the Toner (Print Cartridge)** » **Step 2**

Use the following procedure to install the toner supplied with this printer.

During machine use, a message indicating there is no toner remaining might appear even when there is toner remaining. If it does, remove the toner bottle and reinstall it. The following procedure covers both installation and reinstallation of the toner bottle.

Take the toner bottle out of its box, hold the bottle cap-upward, and then shake the toner bottle up and down seven or eight times. When holding or shaking the toner bottle, take care to hold the actual bottle, not the bottle's cover. Even distribution of toner within the bottle improves print quality.

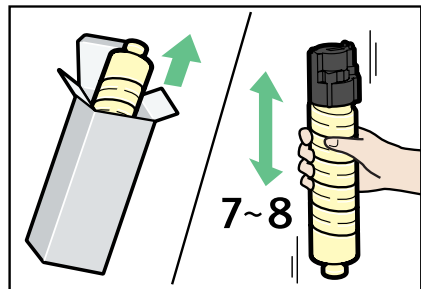

BYK111

While holding the toner bottle so that its label is facing downward, tap the cap end of the toner bottle seven or eight times against the palm of your hand.

Do not touch the toner opening (opposite side to the label). Doing so will result in toner leakage.

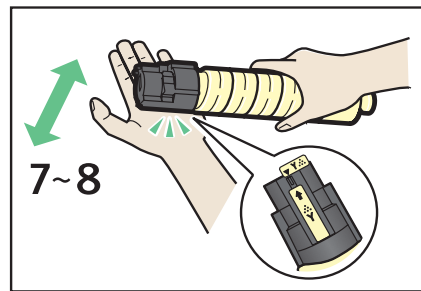

BYK99E

For details about the precautions to take when installing the toner, see “Installing the Toner (Print Cartridge)”, Hardware Guide.

Copyright © 2010

Printed in China

EN GB EN US GCN35-8534



GCN358534